

***DLS**
LIGHTING

EGGER*
LICHT



DLS - Design Lighting Selection präsentiert Lichtwerkzeuge, die der Vielzahl der Anforderungen des Lichtplaners entsprechen und für jede Architektur die passende Lichtstimmung schaffen.

Eindeutiges Markenzeichen unserer Produkte ist die Einfachheit und Klarheit in der Form, die Funktionalität und die dauerhafte Qualität. Ausgereifte Technik in schlichtem, formschönem Design in Verbindung mit hoher Lichtqualität schafft eine außergewöhnliche architektonische Raumwirkung und eine spezielle Beleuchtungsatmosphäre.

DLS - eine gelungene Symbiose aus Architektur, Atmosphäre, Design und Innovation.

DLS - Design Lighting Selection presents lighting tools for the multiple needs of lighting designers, offering the best atmosphere of light for every requirement of architecture.

Brand mark of our luminaires is simplicity and formal precision, functionality and lasting quality. Fully developed technique in homespun and shapely design combined with perfect lighting quality creates an exceeding architectural ambiance and a special lighting atmosphere.

DLS is the right symbiosis of architecture, atmosphere, design and innovation.

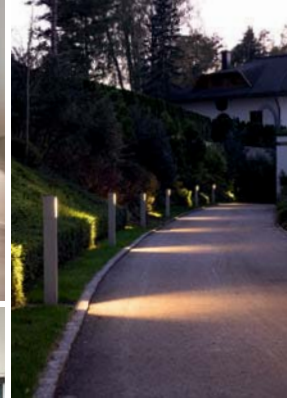

INDEX

DECKEN-LEUCHTEN CEILING



HÄNGE-LEUCHTEN SUSPENSION



WAND-LEUCHTEN WALL

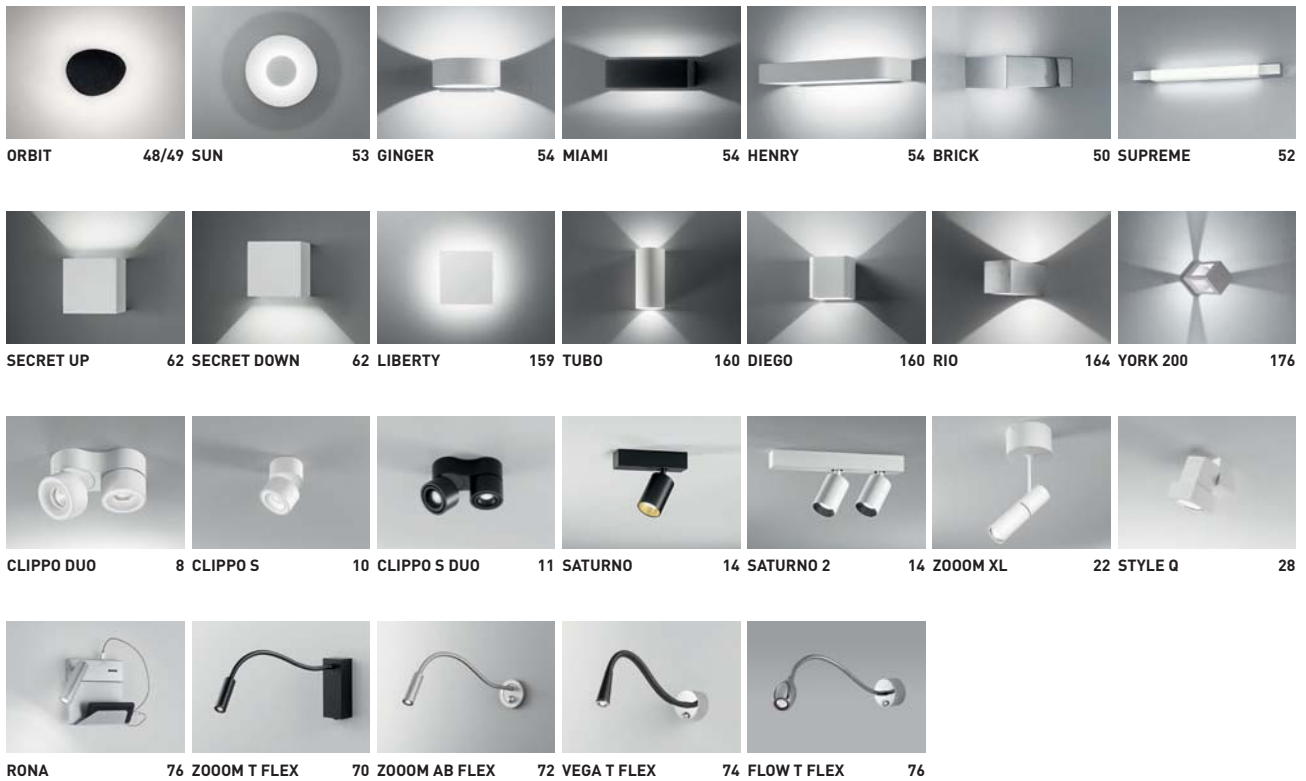

TISCH-/STEH-LEUCHTEN TABLE/ FLOOR



SCHIENEN-STRAHLER TRACK



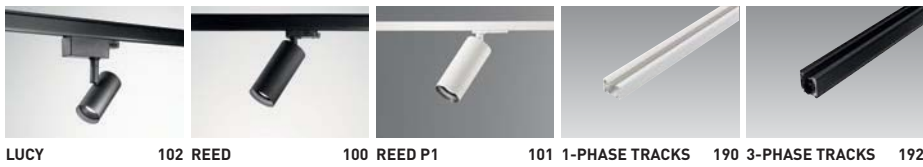

INDEX

DECKEN- EINBAU CEILING RECESSED



BODEN- EINBAU GROUND RECESSED

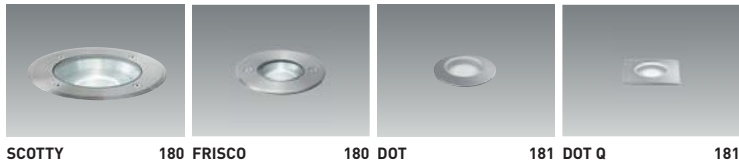

WAND- EINBAU WALL RECESSED



AUSSEN- LEUCHTEN OUTDOOR



ANHANG APPENDIX

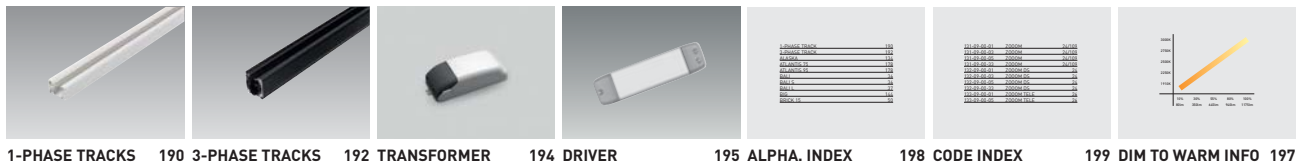

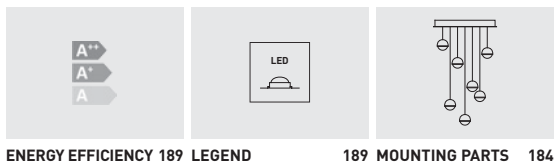
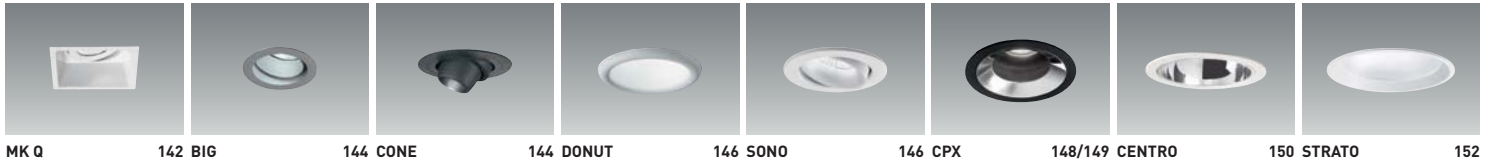
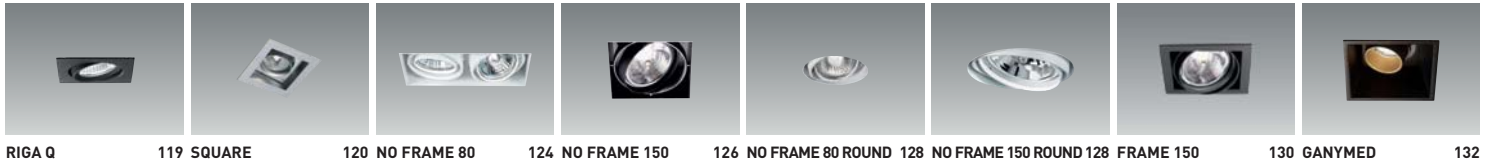

CLIPPO

LED-Wand- und Deckenstrahler
14 W, CRI>90, mit hochwertigem
Aluminiumreflektor und einge-
bautem Driver 230 V, dimmbar
mit Phasenanschnitt-/Phasen-
abschnittdimmer, Gehäuse aus
massivem Aluminium, dreh-
und schwenkbar (350°/90°),
Entblendungsring wahlweise
gold, schwarz oder weiß

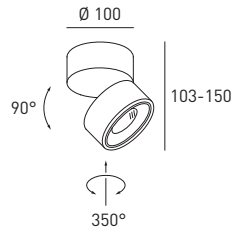

LED-wall and ceiling luminaire
14 W, CRI>90, with high-quality
aluminium reflector and built-in
driver 230 V, leading edge/trailing
edge dimmable, housing made of
aluminium, adjustable (350°/90°),
anti glare ring optionally gold,
black or white

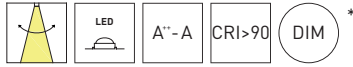

CODE	TYPE	COLOUR	LAMP	LUMEN*	POWER SUPPLY
D775	CLIPPO	white/white	1x14W LED 32° 2700K	1310 lm	incl. driver phase dim
D945	CLIPPO	white/gold	1x14W LED 32° 2700K	1310 lm	incl. driver phase dim
D995	CLIPPO	black/black	1x14W LED 32° 2700K	1310 lm	incl. driver phase dim
D985	CLIPPO	black/gold	1x14W LED 32° 2700K	1310 lm	incl. driver phase dim
D777	CLIPPO	white/white	1x14W LED 32° 3000K	1375 lm	incl. driver phase dim
D947	CLIPPO	white/gold	1x14W LED 32° 3000K	1375 lm	incl. driver phase dim
D997	CLIPPO	black/black	1x14W LED 32° 3000K	1375 lm	incl. driver phase dim
D987	CLIPPO	black/gold	1x14W LED 32° 3000K	1375 lm	incl. driver phase dim



ACCESSORIES



Wabenraster für alle CLIPPO-Versionen
Honey comb louver for all CLIPPO versions

CODE	TYPE	COLOUR
D146	HONEY COMB LOUVER	black



Reflektoren für alle CLIPPO-Versionen
Reflectors for all CLIPPO versions

CODE	TYPE	COLOUR
DH-D994	REFLECTOR 15°	-
DH-D996	REFLECTOR 48°	-

COLOURS

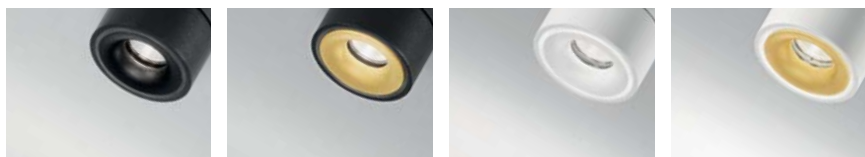

black/black

black/gold

white/white

white/gold



Architekt: KLUNE Innenarchitektur

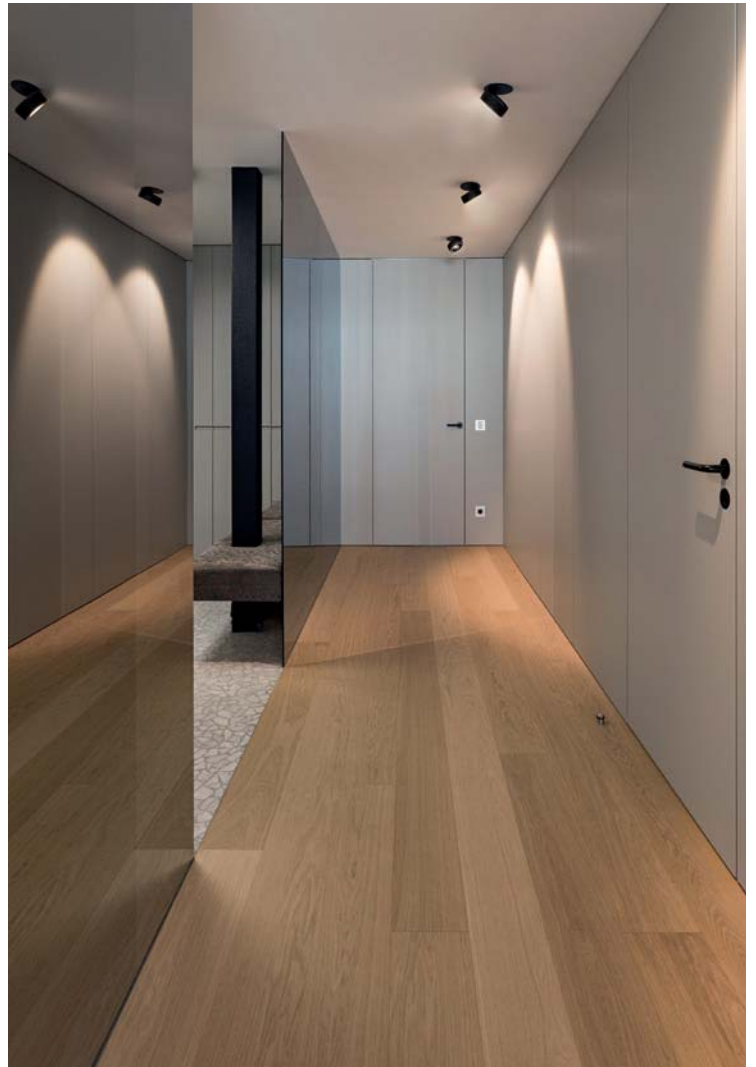

CLIPPO DUO

LED-Wand- und Deckenstrahler 2x 14 W, CRI>90, mit hochwertigem Aluminiumreflektor und eingebautem Driver 230 V, dimmbar mit Phasenabschnittdimmer, Gehäuse aus massivem Aluminium, dreh- und schwenkbar (350°/90°), Entblendungsring wahlweise gold, schwarz oder weiß

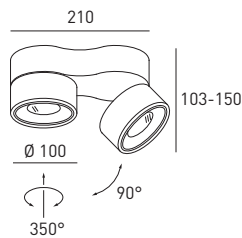

LED-wall and ceiling luminaire 2x 14 W, CRI>90, with high-quality aluminium reflector and built-in driver 230 V, trailing edge dimmable, housing made of aluminium, adjustable (350°/90°), anti glare ring optionally gold, black or white

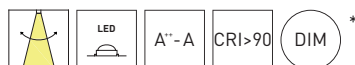

CODE	TYPE	COLOUR	LAMP	LUMEN*	POWER SUPPLY
D611	CLIPPO DUO	white/white	2x14W LED 32° 2700K	2x1310 lm	incl. driver phase dim
D612	CLIPPO DUO	white/gold	2x14W LED 32° 2700K	2x1310 lm	incl. driver phase dim
D609	CLIPPO DUO	black/black	2x14W LED 32° 2700K	2x1310 lm	incl. driver phase dim
D610	CLIPPO DUO	black/gold	2x14W LED 32° 2700K	2x1310 lm	incl. driver phase dim
D615	CLIPPO DUO	white/white	2x14W LED 32° 3000K	2x1375 lm	incl. driver phase dim
D616	CLIPPO DUO	white/gold	2x14W LED 32° 3000K	2x1375 lm	incl. driver phase dim
D613	CLIPPO DUO	black/black	2x14W LED 32° 3000K	2x1375 lm	incl. driver phase dim
D614	CLIPPO DUO	black/gold	2x14W LED 32° 3000K	2x1375 lm	incl. driver phase dim



ACCESSORIES



Wabenraster für alle CLIPPO-Versionen
Honey comb louver for all CLIPPO versions

CODE	TYPE	COLOUR
D146	HONEY COMB LOUVER	black

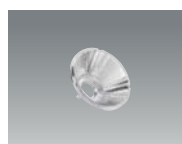

Reflektoren für alle CLIPPO-Versionen
Reflectors for all CLIPPO versions

CODE	TYPE	COLOUR
DH-D994	REFLECTOR 15°	-
DH-D996	REFLECTOR 48°	-

COLOURS

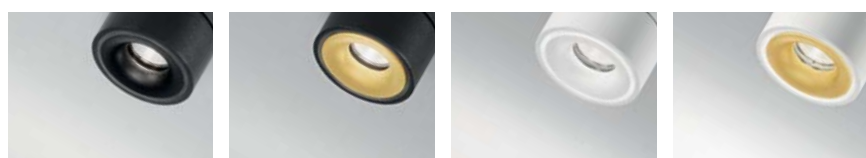

black/black

black/gold

white/white

white/gold

CLIPPO EP

LED-Decken-Halbeinbaustrahler
14 W, CRI>90, mit hochwertigem
Aluminiumreflektor, Gehäuse
aus massivem Aluminium, dreh-
und schwenkbar (350°/90°),
Entblendungsring wahlweise
gold, schwarz oder weiß, Driver
bitte separat bestellen

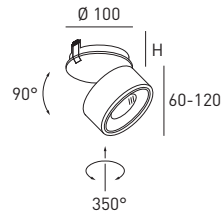

LED-ceiling recessed luminaire
14 W, CRI>90, with high-quality
aluminium reflector, housing
made of aluminium, adjustable
(350°/90°), anti glare ring
optionally gold, black or white,
please order driver separately

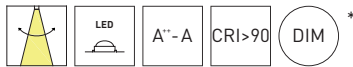

CODE	TYPE	COLOUR	LAMP	LUMEN*	POWER SUPPLY	H
D676	CLIPPO EP	white/white	1x14W LED 32° □ 2700K 500mA	1310 lm	excl. driver	45 mm
D677	CLIPPO EP	white/gold	1x14W LED 32° □ 2700K 500mA	1310 lm	excl. driver	45 mm
D674	CLIPPO EP	black/black	1x14W LED 32° □ 2700K 500mA	1310 lm	excl. driver	45 mm
D675	CLIPPO EP	black/gold	1x14W LED 32° □ 2700K 500mA	1310 lm	excl. driver	45 mm
D692	CLIPPO EP	white/white	1x14W LED 32° □ 3000K 500mA	1375 lm	excl. driver	45 mm
D693	CLIPPO EP	white/gold	1x14W LED 32° □ 3000K 500mA	1375 lm	excl. driver	45 mm
D682	CLIPPO EP	black/black	1x14W LED 32° □ 3000K 500mA	1375 lm	excl. driver	45 mm
D683	CLIPPO EP	black/gold	1x14W LED 32° □ 3000K 500mA	1375 lm	excl. driver	45 mm

H = Einbautiefe / recessed depth

Driver siehe Seite 195 ff. / Driver see page 195 ff.

* Technische Informationen siehe Seite 189 / Lumenangaben sind Nominalwerte - * Technical information see page 189 / Lumen data are nominal data



CLIPPO S
dim to warm

LED-Wand- und Deckenstrahler, mit dim to warm LED 9,5 W, CRI>90, mit hochwertigem Aluminiumreflektor und eingebautem Driver 230 V, dimmbar mit Phasenanschnittdimmer, Gehäuse aus massivem Aluminium, dreh- und schwenkbar (350°/90°), Entblendungsring wahlweise gold, schwarz oder weiß

LED-wall and ceiling luminaire, with dim to warm LED 9,5 W, CRI>90, with high-quality aluminium reflector and built-in driver 230 V, leading edge dimmable, housing made of aluminium, adjustable (350°/90°), anti glare ring optionally gold, black or white

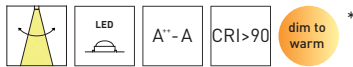
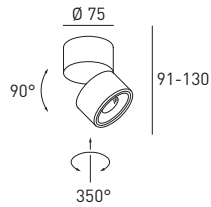

CODE	TYPE	COLOUR	LAMP	LUMEN*	POWER SUPPLY
D345	CLIPPO S	white/white	1x9,5W LED 34° dim to warm	45-915 lm	incl. driver phase dim
D348	CLIPPO S	white/gold	1x9,5W LED 34° dim to warm	45-915 lm	incl. driver phase dim
D338	CLIPPO S	black/black	1x9,5W LED 34° dim to warm	45-915 lm	incl. driver phase dim
D342	CLIPPO S	black/gold	1x9,5W LED 34° dim to warm	45-915 lm	incl. driver phase dim



CLIPPO S mit Wabenraster
with honey comb louver

CLIPPO S DUO

dim to warm

LED-Wand- und Deckenstrahler, mit dim to warm LED 2x9,5 W, CRI>90, mit hochwertigem Aluminiumreflektor und eingebautem Driver 230 V, dimmbar mit Phasenanschnitt-/Phasenabschrittdimmer, Gehäuse aus massivem Aluminium, dreh- und schwenkbar (350°/90°), Entblendungsring wahlweise gold, schwarz oder weiß

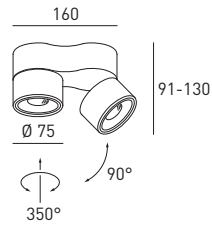

LED-wall and ceiling luminaire, with dim to warm LED 2x9,5 W, CRI>90, with high-quality aluminium reflector and built-in driver 230 V, leading edge/trailing edge dimmable, housing made of aluminium, adjustable (350°/90°), anti glare ring optionally gold, black or white

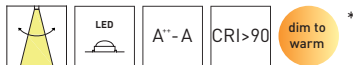

CODE	TYPE	COLOUR	LAMP	LUMEN*	POWER SUPPLY
D331	CLIPPO S DUO	white/white	2x9,5W LED 34° dim to warm	2x45-915 lm	incl. driver phase dim
D336	CLIPPO S DUO	white/gold	2x9,5W LED 34° dim to warm	2x45-915 lm	incl. driver phase dim
D305	CLIPPO S DUO	black/black	2x9,5W LED 34° dim to warm	2x45-915 lm	incl. driver phase dim
D310	CLIPPO S DUO	black/gold	2x9,5W LED 34° dim to warm	2x45-915 lm	incl. driver phase dim

ACCESSORIES



Wabenraster für alle CLIPPO S-Versionen
Honey comb louver for all CLIPPO S versions

CODE	TYPE	COLOUR
D147	HONEY COMB LOUVER	black



Reflektoren für alle CLIPPO S-Versionen
Reflectors for all CLIPPO S versions

CODE	TYPE	COLOUR
DH-D305	REFLECTOR 24°	-
DH-D307	REFLECTOR 48°	-

COLOURS



black/black

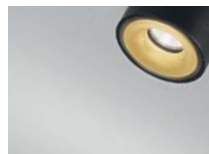

black/gold



white/white



white/gold

GEO

LED-Deckenleuchte 5 W,
CRI>90, extra flache Bauform,
Aufbaueinheit aus Aluminium
mit eingebautem Driver 230 V,
Leuchtenkopf dreh- und
schwenkbar (350°/2x90°)

LED-ceiling luminaire 5 W,
CRI>90, slim design, surface
mounted with built-in driver
230 V, housing made of alu-
minium, LED head adjustable
(350°/2x90°)

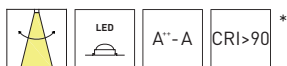
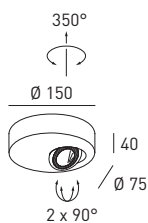

CODE	TYPE	COLOUR	LAMP	LUMEN*	POWER SUPPLY
D607	GEO	white	1x5W LED 24° □ 2700K	370 lm	incl. driver
D605	GEO	black	1x5W LED 24° □ 2700K	370 lm	incl. driver





SATURNO 1

LED-Strahler 9,3 W, CRI>90, Gehäuse aus Aluminiumdruckguss, dimmbar mit Phasenanschnitt-/Phasenabschnitt-dimmer, dreh- und schwenkbar (350°/90°), Entblendungsring wahlweise gold oder schwarz

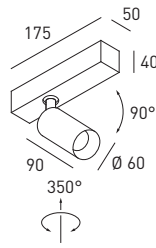

LED-spotlight 9,3 W, CRI>90, made of die-cast aluminium, leading edge/trailing edge dimmable, adjustable (350°/90°), anti glare ring optionally gold or black

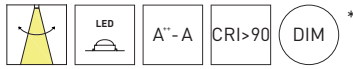

CODE	TYPE	COLOUR	LAMP	LUMEN*	POWER SUPPLY
D926	SATURNO 1	white/black	1x9,3W LED 32° □ 2700K	860 lm	incl. driver phase dim
D927	SATURNO 1	white/gold	1x9,3W LED 32° □ 2700K	860 lm	incl. driver phase dim
D924	SATURNO 1	black/black	1x9,3W LED 32° □ 2700K	860 lm	incl. driver phase dim
D925	SATURNO 1	black/gold	1x9,3W LED 32° □ 2700K	860 lm	incl. driver phase dim

SATURNO 2

LED-Strahler 2x9,3 W, CRI>90, Gehäuse aus Aluminiumdruckguss, dimmbar mit Phasenanschnitt-/Phasenabschnitt-dimmer, dreh- und schwenkbar (350°/90°), Entblendungsring wahlweise gold oder schwarz

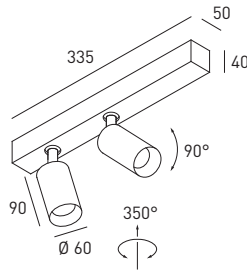

LED-spotlight 2x9,3 W, CRI>90, made of die-cast aluminium, leading edge/trailing edge dimmable, adjustable (350°/90°), anti glare ring optionally gold or black

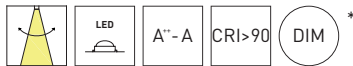

CODE	TYPE	COLOUR	LAMP	LUMEN*	POWER SUPPLY
D936	SATURNO 2	white/black	2x9,3W LED 32° □ 2700K	2x860 lm	incl. driver phase dim
D937	SATURNO 2	white/gold	2x9,3W LED 32° □ 2700K	2x860 lm	incl. driver phase dim
D934	SATURNO 2	black/black	2x9,3W LED 32° □ 2700K	2x860 lm	incl. driver phase dim
D935	SATURNO 2	black/gold	2x9,3W LED 32° □ 2700K	2x860 lm	incl. driver phase dim

ACCESSORIES



Wabenraster für alle SATURNO-Versionen
Honey comb louver for all SATURNO versions

CODE	TYPE	COLOUR
13114-04	HONEY COMB LOUVER	black



Reflektoren für alle SATURNO-Versionen
Reflectors for all SATURNO versions

CODE	TYPE	COLOUR
DH-D994	REFLECTOR 15°	-
DH-D996	REFLECTOR 48°	-

COLOURS



black/black



black/gold



white/black

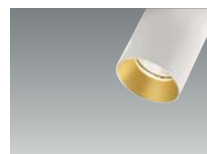

white/gold

SATURNO IN

LED-Halbeinbaustrahler
9,3 W, CRI>90, Gehäuse aus
Aluminiumdruckguss, dreh-
und schwenkbar (350°/45°),
Entblendungsring wahlweise
gold oder schwarz, Driver
bitte separat bestellen

LED-recessed luminaire 9,3 W,
CRI>90, made of die-cast alu-
minium, adjustable (350°/45°),
anti glare ring optionally gold
or black, please order driver
separately

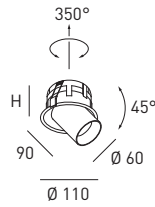
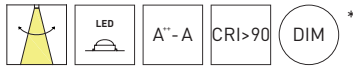

CODE	TYPE	COLOUR	LAMP	LUMEN	POWER SUPPLY	H
D559	SATURNO IN	white/black	1x9,3W LED 32° 2700K 500mA	860 lm	excl. driver	70 mm
D560	SATURNO IN	white/gold	1x9,3W LED 32° 2700K 500mA	860 lm	excl. driver	70 mm
D557	SATURNO IN	black/black	1x9,3W LED 32° 2700K 500mA	860 lm	excl. driver	70 mm
D558	SATURNO IN	black/gold	1x9,3W LED 32° 2700K 500mA	860 lm	excl. driver	70 mm

H = Einbautiefe / recessed depth

Driver siehe Seite 195 ff. / Driver see page 195 ff.

* Technische Informationen siehe Seite 189 / Lumenangaben sind Nominalwerte
* Technical information see page 189 / Lumen data are nominal data



LIGHT BOX SOFT 1

Deckenstrahler 230 V, Gehäuse aus massivem Aluminium, Leuchtmittel kardanisches gelagert, für LED- und Halogen-Leuchtmittel geeignet

Ceiling luminaire 230 V, housing made of aluminium, illuminant gimbal mounted, LED and halogen lamps are suitable

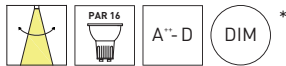
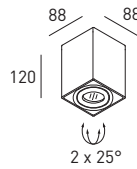

CODE	TYPE	COLOUR	LAMP	POWER SUPPLY
D374	LIGHT BOX SOFT 1	white	1xGU10 LED or 1x30W halogen	230 V
D385	LIGHT BOX SOFT 1	black	1xGU10 LED or 1x30W halogen	230 V

LIGHT BOX SOFT 2

2-fach Deckenstrahler 230 V, Gehäuse aus massivem Aluminium, Leuchtmittel kardanisches gelagert, für LED- und Halogen-Leuchtmittel geeignet

Double ceiling luminaire 230 V, housing made of aluminium, illuminant gimbal mounted, LED and halogen lamps are suitable

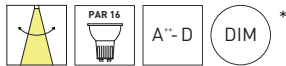
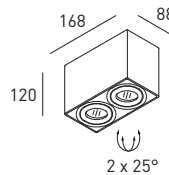

CODE	TYPE	COLOUR	LAMP	POWER SUPPLY
D375	LIGHT BOX SOFT 2	white	2xGU10 LED or 2x30W halogen	230 V
D386	LIGHT BOX SOFT 2	black	2xGU10 LED or 2x30W halogen	230 V

LIGHT BOX SOFT 3

3-fach Deckenstrahler 230 V, Gehäuse aus massivem Aluminium, Leuchtmittel kardanisches gelagert, für LED- und Halogen-Leuchtmittel geeignet

Triple ceiling luminaire 230 V, housing made of aluminium, illuminant gimbal mounted, LED and halogen lamps are suitable

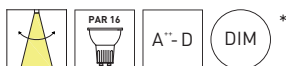
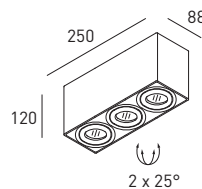

CODE	TYPE	COLOUR	LAMP	POWER SUPPLY
D376	LIGHT BOX SOFT 3	white	3xGU10 LED or 3x30W halogen	230 V
D387	LIGHT BOX SOFT 3	black	3xGU10 LED or 3x30W halogen	230 V



Architekt: Kamleitner Architekten / Foto: Andrea Ruster

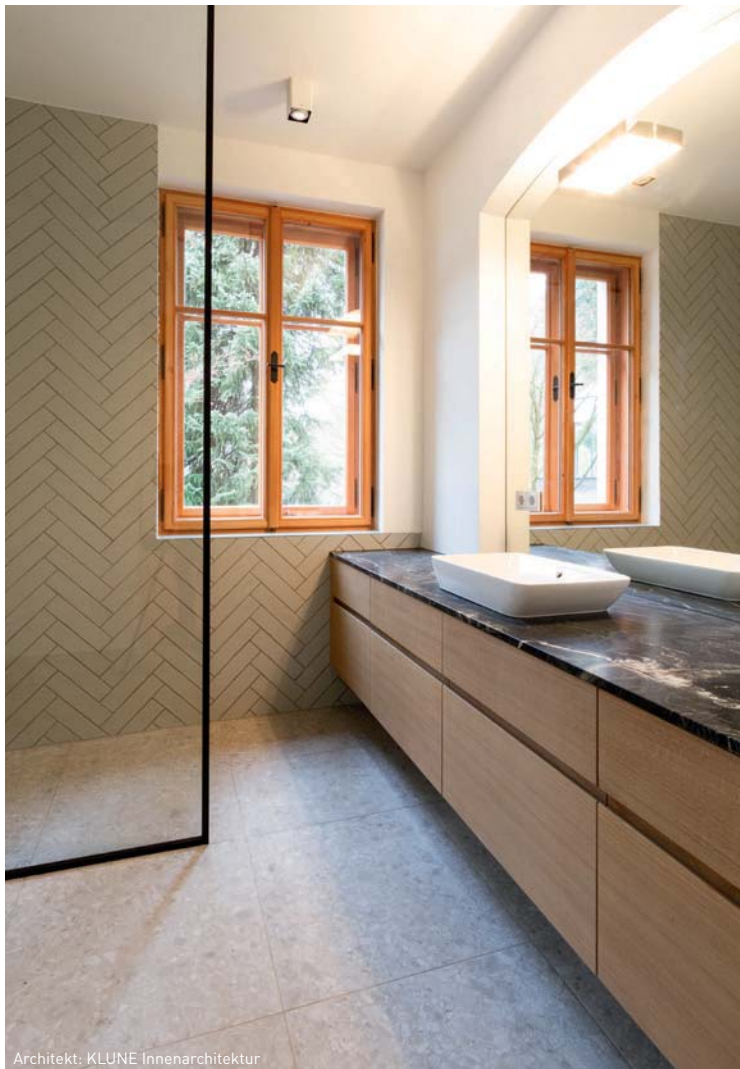

Architekt: KLUNE Innenarchitektur

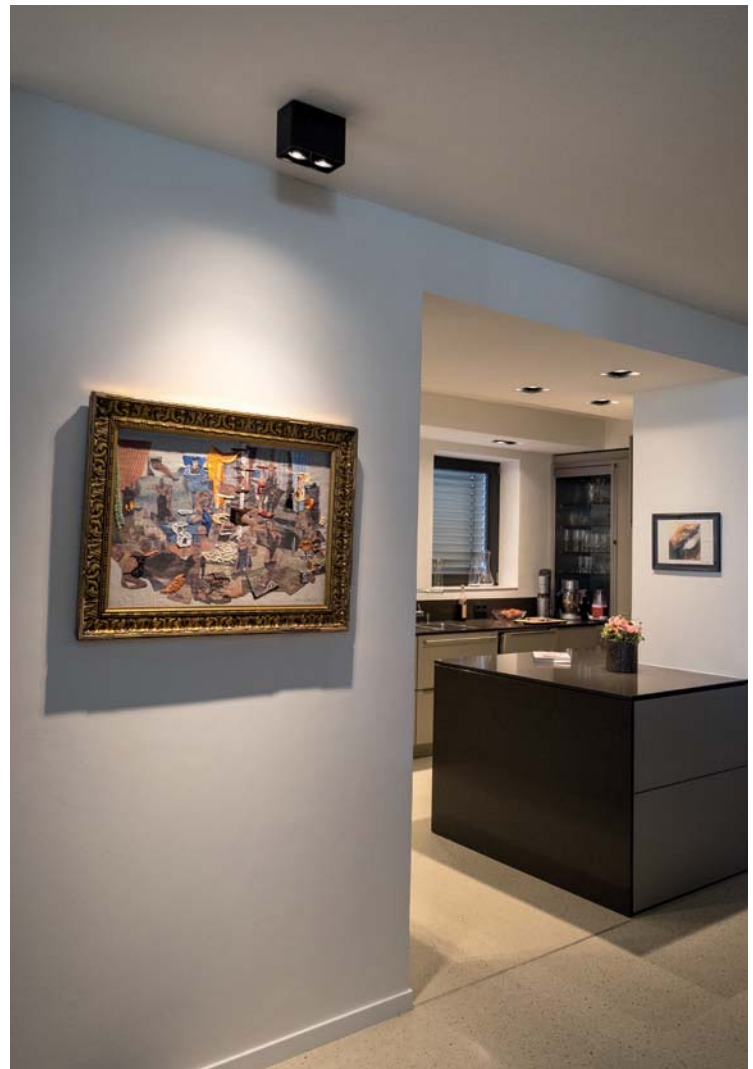

LIGHT BOX 1

Deckenstrahler 230 V, Gehäuse aus massivem Aluminium, Leuchtmittel kardanisch gelagert, für LED- und Halogen-Leuchtmittel geeignet

Ceiling luminaire 230 V, housing made of aluminium, illuminant gimbal mounted, LED and halogen lamps are suitable

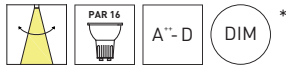
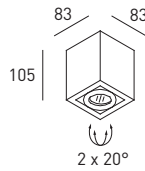

CODE	TYPE	COLOUR	LAMP	POWER SUPPLY
D371	LIGHT BOX 1	white	1xGU10 LED or 1x30W halogen	230 V
D367	LIGHT BOX 1	black	1xGU10 LED or 1x30W halogen	230 V
D361	LIGHT BOX 1	grey	1xGU10 LED or 1x30W halogen	230 V

LIGHT BOX 2

2-fach Deckenstrahler 230 V, Gehäuse aus massivem Aluminium, Leuchtmittel kardanisch gelagert, für LED- und Halogen-Leuchtmittel geeignet

Double ceiling luminaire 230 V, housing made of aluminium, illuminant gimbal mounted, LED and halogen lamps are suitable

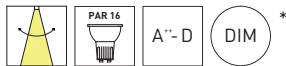
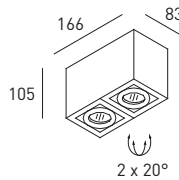

CODE	TYPE	COLOUR	LAMP	POWER SUPPLY
D372	LIGHT BOX 2	white	2xGU10 LED or 2x30W halogen	230 V
D368	LIGHT BOX 2	black	2xGU10 LED or 2x30W halogen	230 V
D362	LIGHT BOX 2	grey	2xGU10 LED or 2x30W halogen	230 V

LIGHT BOX 3

3-fach Deckenstrahler 230 V, Gehäuse aus massivem Aluminium, Leuchtmittel kardanisch gelagert, für LED- und Halogen-Leuchtmittel geeignet

Triple ceiling luminaire 230 V, housing made of aluminium, illuminant gimbal mounted, LED and halogen lamps are suitable

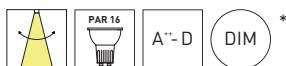
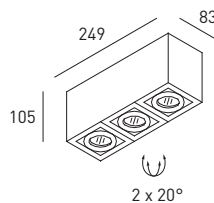

CODE	TYPE	COLOUR	LAMP	POWER SUPPLY
D373	LIGHT BOX 3	white	3xGU10 LED or 3x30W halogen	230 V
D369	LIGHT BOX 3	black	3xGU10 LED or 3x30W halogen	230 V
D363	LIGHT BOX 3	grey	3xGU10 LED or 3x30W halogen	230 V

LIGHT BOX 4

4-fach Deckenstrahler 230 V,
Gehäuse aus massivem Aluminium,
Leuchtmittel kardanisches gelagert,
für LED- und Halogen-Leuchtmittel geeignet

Quad ceiling luminaire 230 V,
housing made of aluminium,
illuminant gimbal mounted,
LED and halogen lamps are suitable

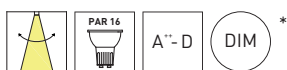
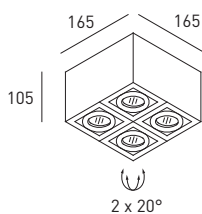

CODE	TYPE	COLOUR	LAMP	POWER SUPPLY
D370	LIGHT BOX 4	white	4xGU10 LED or 4x30W halogen	230 V
D360	LIGHT BOX 4	grey	4xGU10 LED or 4x30W halogen	230 V

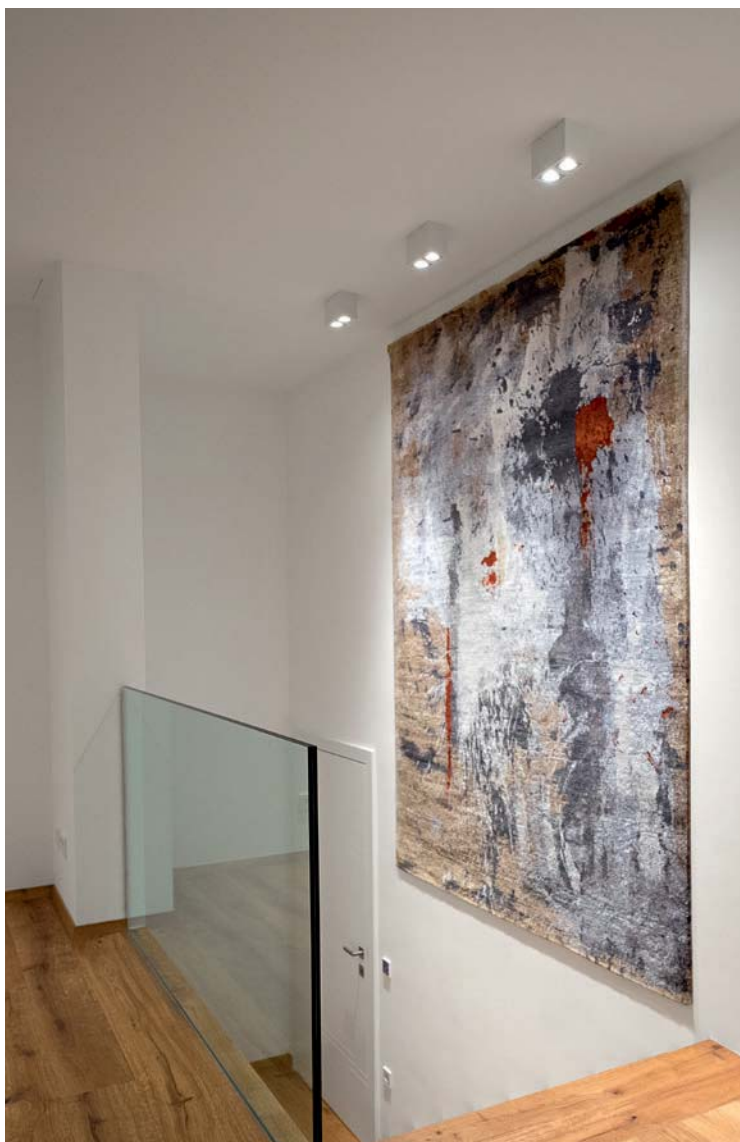

LIGHT HOUSE 1 LED-Deckenstrahler 9,3 W, CRI>90, mit hochwertigem Aluminiumreflektor und eingebautem Driver 230 V, Gehäuse aus massivem Aluminium, LED kardanisch gelagert, dimmbar mit Phasenanschnitt-/Phasenabschrittdimmer

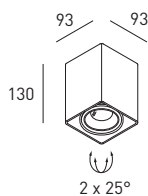

LED-ceiling luminaire 9,3 W, CRI>90, with high value aluminium reflector and built-in driver 230 V, housing made of aluminium, LED gimbal mounted, dimmable with leading edge/trailing edge

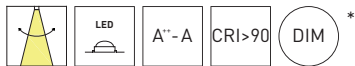

CODE	TYPE	COLOUR	LAMP	LUMEN*	POWER SUPPLY
D994	LIGHT HOUSE 1	white	1x9,3W LED 32° □ 2700K	860 lm	incl. driver phase dim

LIGHT HOUSE 2 2-fach LED-Deckenstrahler 2x9,3 W, CRI>90, mit hochwertigem Aluminiumreflektor und eingebautem Driver 230 V, Gehäuse aus massivem Aluminium, LED kardanisch gelagert, dimmbar mit Phasenanschnitt-/Phasenabschrittdimmer

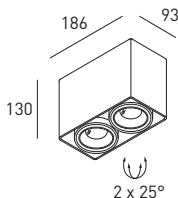

Double LED-ceiling luminaire 2x9,3 W, CRI>90, with high value aluminium reflector and built-in driver 230 V, housing made of aluminium, LED gimbal mounted, dimmable with leading edge/trailing edge

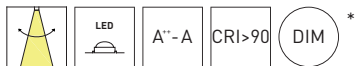

CODE	TYPE	COLOUR	LAMP	LUMEN*	POWER SUPPLY
D996	LIGHT HOUSE 2	white	2x9,3W LED 32° □ 2700K	2x860 lm	incl. driver phase dim

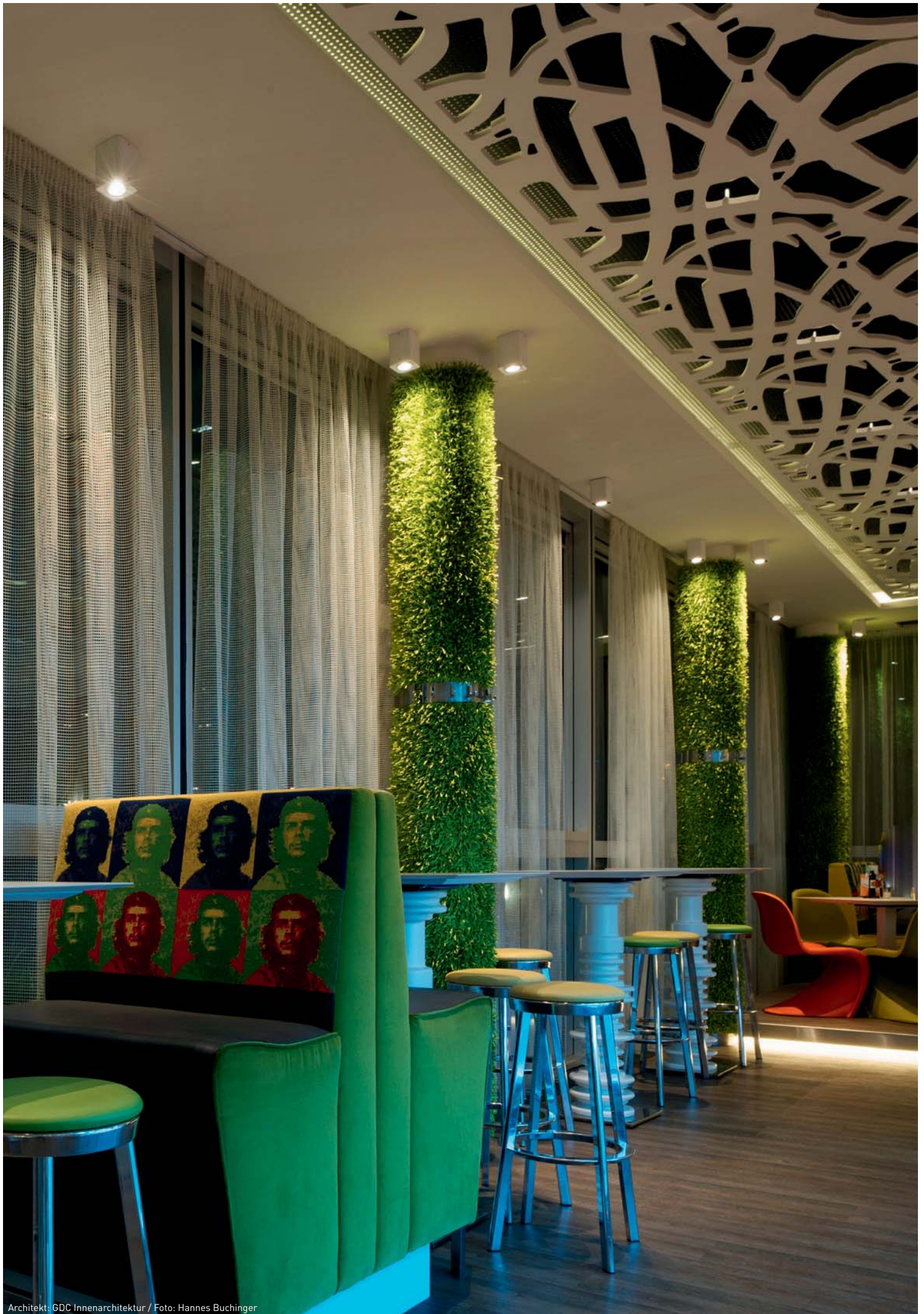

ZOOM XL

LED-Strahler 4,1 W, CRI>90, mit Aufbaugehäuse und eingebautem Driver 230 V, hochwertiger Glasoptik, Abstrahlwinkel fokussierbar von 15° bis 60°, dimmbar mit Phasenanschnitt-/Phasenabschnittdimmer, dreh- und schwenkbar (350°/120°)

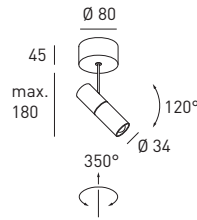

LED-fixture 4,1 W, CRI>90, surface mounted, with built-in driver 230 V, high-quality glass lens, focusable from 15° to 60°, leading edge/trailing edge dimmable, adjustable (350°/120°)

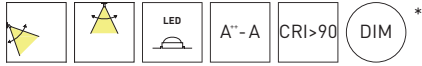

CODE	TYPE	COLOUR	LAMP	LUMEN*	POWER SUPPLY
134-09-00-03T	ZOOM XL	white	1x4,1W LED 15°-60° □ 3000K	420 lm	incl. driver phase dim
134-09-00-05T	ZOOM XL	black	1x4,1W LED 15°-60° □ 3000K	420 lm	incl. driver phase dim
134-09-00-01T	ZOOM XL	chrome	1x4,1W LED 15°-60° □ 3000K	420 lm	incl. driver phase dim
134-09-00-33T	ZOOM XL	platinum	1x4,1W LED 15°-60° □ 3000K	420 lm	incl. driver phase dim

2700K und 4000K LED auf Anfrage / 2700K and 4000K LED on request

ZOOM XL

LED-Einbaustrahler 4,1 W, CRI>90, mit Einbauplatte, hochwertiger Glasoptik, Abstrahlwinkel fokussierbar von 15° bis 60°, dreh- und schwenkbar (350°/120°), Driver bitte separat bestellen

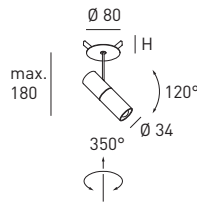

LED-recessed fixture 4,1 W, CRI>90, with recessed plate, high-quality glass lens, focusable from 15° to 60°, adjustable (350°/120°), please order driver separately

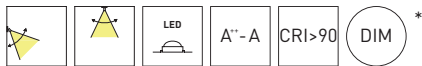

CODE	TYPE	COLOUR	LAMP	LUMEN*	POWER SUPPLY	H
134-09-00-03EP	ZOOM XL	white	1x4,1W LED 15°-60° □ 3000K 250mA	420 lm	excl. driver	45 mm
134-09-00-05EP	ZOOM XL	black	1x4,1W LED 15°-60° □ 3000K 250mA	420 lm	excl. driver	45 mm
134-09-00-01EP	ZOOM XL	chrome	1x4,1W LED 15°-60° □ 3000K 250mA	420 lm	excl. driver	45 mm
134-09-00-33EP	ZOOM XL	platinum	1x4,1W LED 15°-60° □ 3000K 250mA	420 lm	excl. driver	45 mm

2700K und 4000K LED auf Anfrage / 2700K and 4000K LED on request

H = Einbautiefe / recessed depth

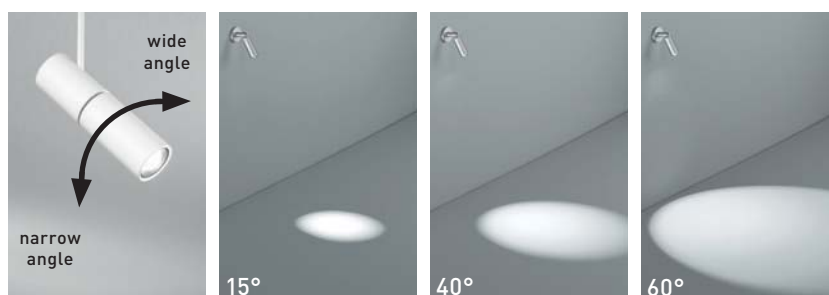

ZOOM - Leuchten sind von 15° bis 60° stufenlos fokussierbar

ZOOM luminaires are continuously focusable from 15° to 60°

Driver siehe Seite 195 ff. / Driver see page 195 ff.



Lichtplanung: IBO Innovationsbüro Overath



Lichtplanung: IBO Innovationsbüro Overath

Z000M DS

LED-Strahler 2 W, CRI>90, mit Aufbauplatte und hochwertiger Glasoptik, Abstrahlwinkel fokussierbar von 15° bis 60°, dreh- und schwenkbar (350°/90°), Driver bitte separat bestellen

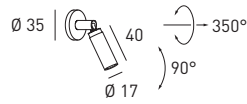

LED-fixture 2 W, CRI>90, surface mounted, with high-quality glass lens, focusable from 15° to 60°, adjustable (350°/90°), please order driver separately

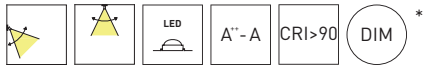

CODE	TYPE	COLOUR	LAMP	LUMEN*	POWER SUPPLY
132-09-00-03	Z000M DS	white	1x2W LED 15°-60° □ 3000K 500mA	190 lm	excl. driver
132-09-00-05	Z000M DS	black	1x2W LED 15°-60° □ 3000K 500mA	190 lm	excl. driver
132-09-00-01	Z000M DS	chrome	1x2W LED 15°-60° □ 3000K 500mA	190 lm	excl. driver
132-09-00-33	Z000M DS	platinum	1x2W LED 15°-60° □ 3000K 500mA	190 lm	excl. driver

2700K und 4000K LED auf Anfrage / 2700K and 4000K LED on request

Z000M

LED-Einbaustrahler 2 W, CRI>90, mit hochwertiger Glasoptik, Abstrahlwinkel fokussierbar von 15° bis 60°, schwenkbar (2x25°), Driver bitte separat bestellen



LED-recessed fixture 2 W, CRI>90, with high-quality glass lens, focusable from 15° to 60°, adjustable (2x25°), please order driver separately

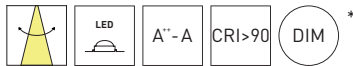

CODE	TYPE	COLOUR	LAMP	LUMEN*	POWER SUPPLY	H
131-09-00-03	Z000M	white	1x2W LED 15°-60° □ 3000K 500mA	190 lm	excl. driver	27 mm
131-09-00-05	Z000M	black	1x2W LED 15°-60° □ 3000K 500mA	190 lm	excl. driver	27 mm
131-09-00-01	Z000M	chrome	1x2W LED 15°-60° □ 3000K 500mA	190 lm	excl. driver	27 mm
131-09-00-33	Z000M	platinum	1x2W LED 15°-60° □ 3000K 500mA	190 lm	excl. driver	27 mm

2700K und 4000K LED auf Anfrage / 2700K and 4000K LED on request

H = Einbautiefe / recessed depth

ACCESSORIES



Unterputzdose für Z000M
Mounting box for Z000M

CODE	TYPE	COLOUR
9000-0141	MOUNTING BOX 41	-

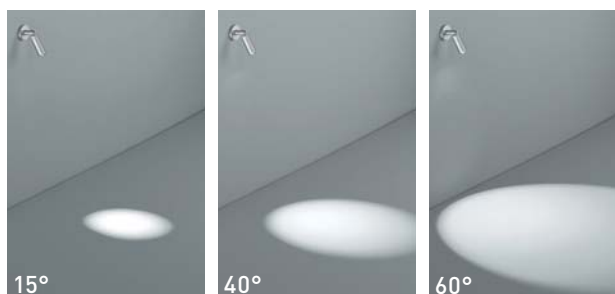
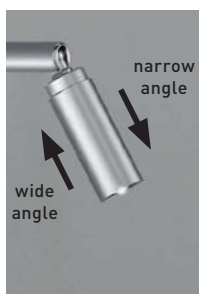
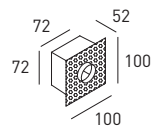

Z000M-Leuchten sind von 15° bis 60° stufenlos fokussierbar

Z000M luminaires are continuously focusable from 15° to 60°

Driver siehe Seite 195 ff. / Driver see page 195 ff.



Foto: Martin Lugger



ZOOM TELE

LED-Strahler 2 W, CRI>90, mit Aufbauplatte und hochwertiger Glasoptik, Abstrahlwinkel fokussierbar von 15° bis 60°, dreh- und schwenkbar (350°/90°), zusätzlich höhenverstellbar, Driver bitte separat bestellen

LED-fixture 2 W, CRI>90, surface mounted, with high-quality glass lens, focusable from 15° to 60°, adjustable (350°/90°), also adjustable height, please order driver separately

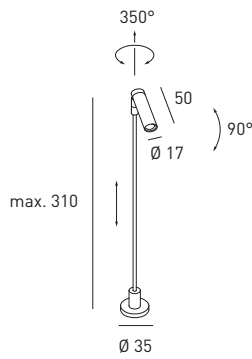
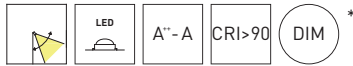

CODE	TYPE	COLOUR	LAMP	LUMEN*	POWER SUPPLY
133-09-00-05	ZOOM TELE	black	1x2W LED 15°-60° □ 3000K 500mA	190 lm	excl. driver
133-09-00-01	ZOOM TELE	chrome	1x2W LED 15°-60° □ 3000K 500mA	190 lm	excl. driver
133-09-00-33	ZOOM TELE	platinum	1x2W LED 15°-60° □ 3000K 500mA	190 lm	excl. driver

2700K und 4000K LED auf Anfrage / 2700K and 4000K LED on request

ZOOM TELE 2

LED-Strahler 2x2 W, CRI>90, mit Aufbauplatte und hochwertiger Glasoptik, Abstrahlwinkel fokussierbar von 15° bis 60°, dreh- und schwenkbar (350°/90°), zusätzlich höhenverstellbar, Driver bitte separat bestellen

LED-fixture 2x2 W, CRI>90, surface mounted, with high-quality glass lens, focusable from 15° to 60°, adjustable (350°/90°), also adjustable height, please order driver separately

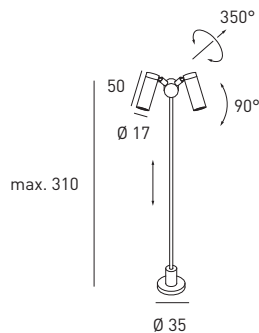

CODE	TYPE	COLOUR	LAMP	LUMEN*	POWER SUPPLY
142-09-00-05	ZOOM TELE 2	black	2x2W LED 15°-60° □ 3000K 500mA	2x190 lm	excl. driver
142-09-00-01	ZOOM TELE 2	chrome	2x2W LED 15°-60° □ 3000K 500mA	2x190 lm	excl. driver
142-09-00-33	ZOOM TELE 2	platinum	2x2W LED 15°-60° □ 3000K 500mA	2x190 lm	excl. driver

2700K und 4000K LED auf Anfrage / 2700K and 4000K LED on request

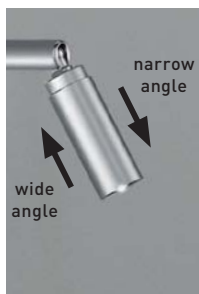

ZOOM- Leuchten sind von 15° bis 60° stufenlos fokussierbar

ZOOM luminaires are continuously focusable from 15° to 60°

Driver siehe Seite 195 ff. / Driver see page 195 ff.



STYLE Q

Wand- und Deckenstrahler 230 V, Gehäuse aus massivem Aluminium, schwenkbar (2x90°), für LED- und Halogen-Leuchtmittel geeignet

Wall and ceiling luminaire 230 V, housing made of aluminium, adjustable (2x90°), LED and halogen lamps are suitable

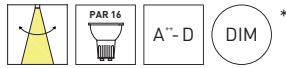
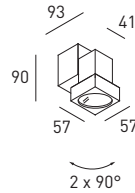

CODE	TYPE	COLOUR	LAMP	POWER SUPPLY
D333	STYLE Q	white	1xGU10 LED or 1x30W halogen	230 V
D332	STYLE Q	alu	1xGU10 LED or 1x30W halogen	230 V

STYLE Q DUO

Wand- und Deckenstrahler 230 V, Gehäuse aus massivem Aluminium, schwenkbar (2x90°), für LED- und Halogen-Leuchtmittel geeignet

Wall and ceiling luminaire 230 V, housing made of aluminium, adjustable (2x90°), LED and halogen lamps are suitable

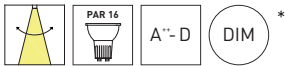
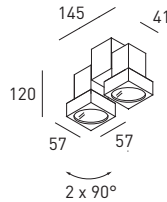

CODE	TYPE	COLOUR	LAMP	POWER SUPPLY
D335	STYLE Q DUO	white	2xGU10 LED or 2x30W halogen	230 V
D334	STYLE Q DUO	alu	2xGU10 LED or 2x30W halogen	230 V

STYLE DUO

Wand- und Deckenstrahler 230 V, Gehäuse aus massivem Aluminium natur gebürstet, schwenkbar (2x90°), für LED- und Halogen-Leuchtmittel geeignet

Wall and ceiling luminaire 230 V, housing made of natural brushed aluminium, adjustable (2x90°), LED and halogen lamps are suitable

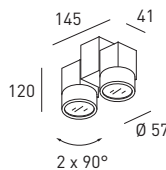

CODE	TYPE	COLOUR	LAMP	POWER SUPPLY
D344	STYLE DUO	alu	2xGU10 LED or 2x30W halogen	230 V

ACCESSORIES



Montageplatte (optional) für STYLE- und STYLE Q-Strahler
Mounting plate (optional) for STYLE- and STYLE Q-luminaires

CODE	TYPE	COLOUR
D134	STYLE MOUNTING PLATE	white
D133	STYLE MOUNTING PLATE	alu



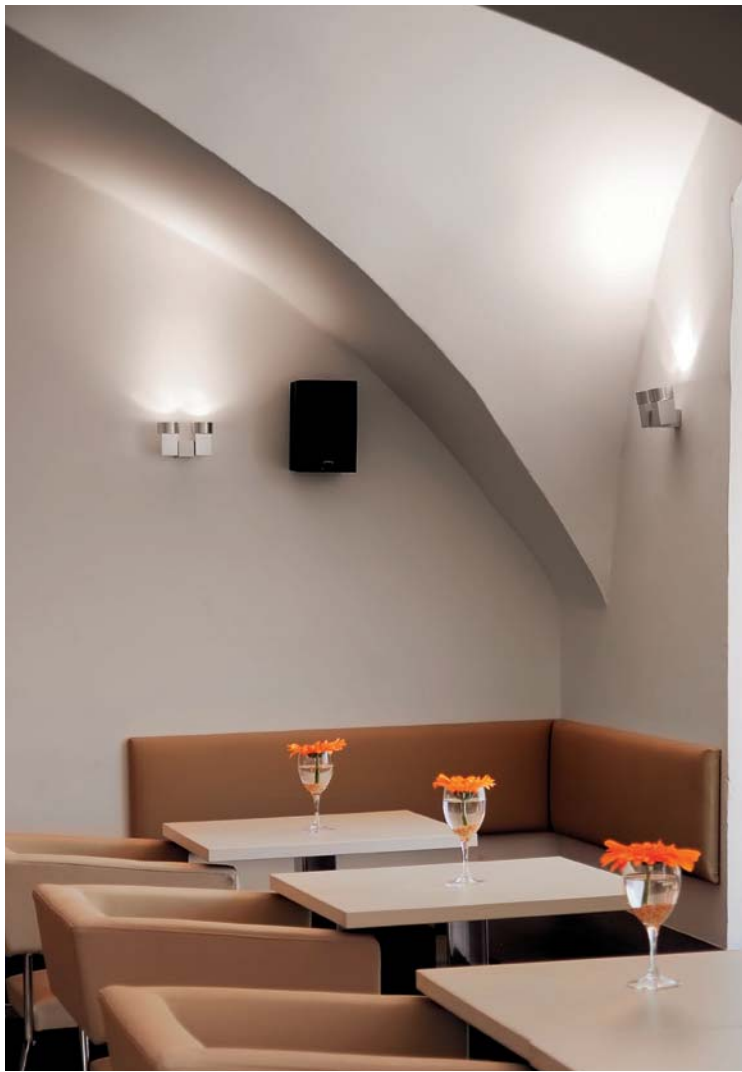

PIPER S

LED-Deckenleuchte 7 W, CRI>90, mit eingebautem Driver 230 V, optional dimmbar mit Phasenanschnitt-/Phasenabschrittdimmer, Gehäuse aus massivem Aluminium, mit Acrylglasabdeckung

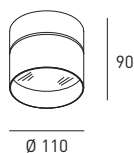

LED-ceiling luminaire 7 W, CRI>90, with built-in driver 230 V, optionally leading edge/trailing edge dimmable, housing made of aluminium, with acrylic glass cover

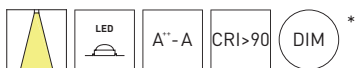

CODE	TYPE	COLOUR	LAMP	LUMEN*	POWER SUPPLY
D252	PIPER S	white	1x7W LED □ 3000K	730 lm	incl. driver
D752	PIPER S dim	white	1x7W LED □ 3000K	730 lm	incl. driver phase dim

PIPER

LED-Deckenleuchte 15 W, CRI>90, mit eingebautem Driver 230 V, optional dimmbar mit Phasenanschnitt-/Phasenabschrittdimmer, Gehäuse aus massivem Aluminium, mit Acrylglasabdeckung

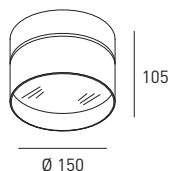

LED-ceiling luminaire 15 W, CRI>90, with built-in driver 230 V, optionally leading edge/trailing edge dimmable, housing made of aluminium, with acrylic glass cover

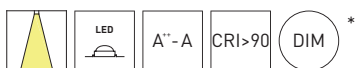

CODE	TYPE	COLOUR	LAMP	LUMEN*	POWER SUPPLY
D253	PIPER	white	1x15W LED □ 3000K	1760 lm	incl. driver
D753	PIPER dim	white	1x15W LED □ 3000K	1760 lm	incl. driver phase dim

HANGING PIPER

LED-Hängeleuchte 15 W, CRI>90, mit eingebautem Driver 230 V, optional dimmbar mit Phasenanschnitt-/Phasenabschrittdimmer, Gehäuse aus massivem Aluminium, mit Acrylglasabdeckung, Kabel kürzbar

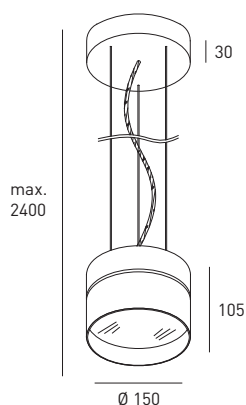

LED-pendant 15 W, CRI>90, with built-in driver 230 V, optionally leading edge/trailing edge dimmable, housing made of aluminium, with acrylic glass cover, cable may be cut to any length

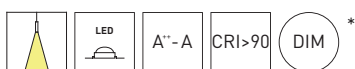

CODE	TYPE	COLOUR	LAMP	LUMEN*	POWER SUPPLY
D211	HANGING PIPER	white	1x15W LED □ 3000K	1760 lm	incl. driver
D711	HANGING PIPER dim	white	1x15W LED □ 3000K	1760 lm	incl. driver phase dim

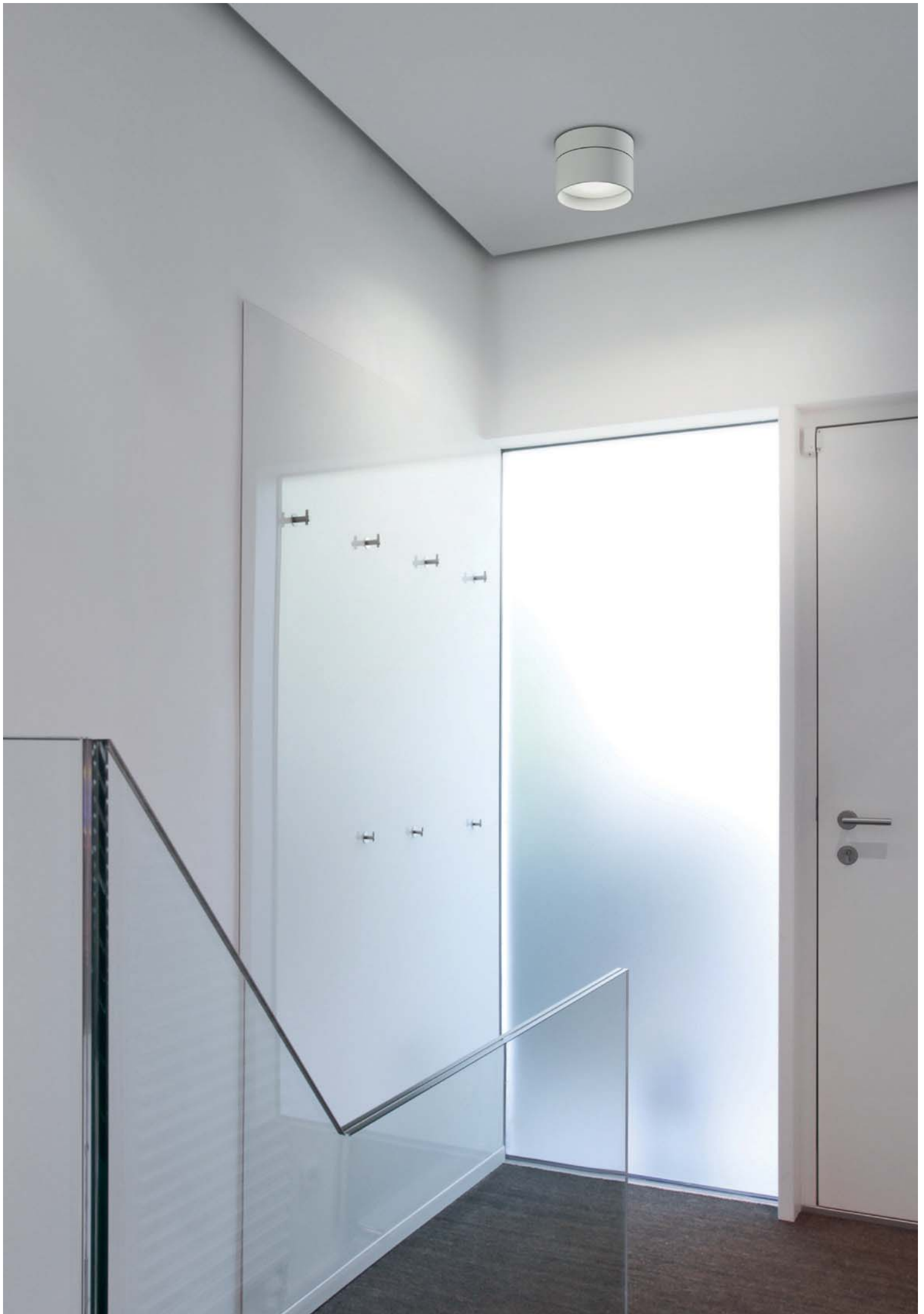

NEWTON 35

LED-Aufbaustrahler 230 V, mit 8 W AC-LED, CRI>90, dimmbar mit Phasenanschnittdimmer, mit hochwertigem Aluminiumreflektor und spezieller Glasabdeckung, Anschlussklemme extern, für den Innen- und Außenbereich verwendbar, IP54

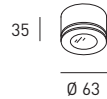

LED-luminaire 230 V, with 8 W AC-LED, CRI>90, leading edge dimmable, with high value aluminium reflector and special glass cover, connector external, to be used in indoor and outdoor areas, IP54

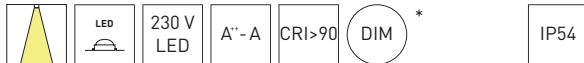

CODE	TYPE	COLOUR	LAMP	LUMEN*	POWER SUPPLY
D748	NEWTON 35	white	1x8W LED 30° □ 3000K	560 lm	230 V phase dim
D788	NEWTON 35	grey	1x8W LED 30° □ 3000K	560 lm	230 V phase dim

50° Abstrahlwinkel auf Anfrage / 50° beam angle on request

NEWTON 55

LED-Aufbaustrahler 230 V, mit 8 W AC-LED, CRI>90, dimmbar mit Phasenanschnittdimmer, mit hochwertigem Aluminiumreflektor und spezieller Glasabdeckung, für den Innen- und Außenbereich verwendbar, IP54

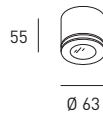

LED-luminaire 230 V, with 8 W AC-LED, CRI>90, leading edge dimmable, with high value aluminium reflector and special glass cover, to be used in indoor and outdoor areas, IP54

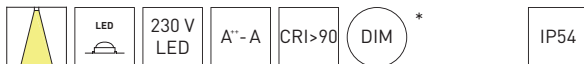

CODE	TYPE	COLOUR	LAMP	LUMEN*	POWER SUPPLY
D948	NEWTON 55	white	1x8W LED 30° □ 3000K	560 lm	230 V phase dim
D988	NEWTON 55	grey	1x8W LED 30° □ 3000K	560 lm	230 V phase dim

50° Abstrahlwinkel auf Anfrage / 50° beam angle on request





KUBUS

Deckenleuchte 230 V, Gehäuse aus stranggepresstem Aluminium, mit tiefer gesetztem Leuchtmittel und geringem indirekten Lichtanteil, für LED- und Halogen-Leuchtmittel geeignet

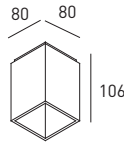

Ceiling luminaire 230 V, housing made of extruded aluminium, with recessed illuminant and low indirect lighting, LED and halogen lamps are suitable

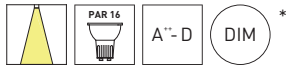

CODE	TYPE	COLOUR	LAMP	POWER SUPPLY
D522	KUBUS	white	1xGU10 LED or 1x30W halogen	230 V
D523	KUBUS	black	1xGU10 LED or 1x30W halogen	230 V
D521	KUBUS	grey	1xGU10 LED or 1x30W halogen	230 V

CL 15

Deckenstrahler 230 V, Gehäuse aus Aluminium, für LED-Leuchtmittel geeignet, für den Innen- und Außenbereich geeignet, IP44

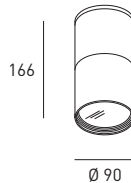

Ceiling luminaire 230 V, housing made of aluminium, LED lamps are suitable, to be used in indoor and outdoor areas, IP44

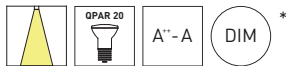

IP44



CODE	TYPE	COLOUR	LAMP	POWER SUPPLY
D352	CL 15	white	1xE27 LED	230 V
D422	CL 15	black	1xE27 LED	230 V
D351	CL 15	grey	1xE27 LED	230 V

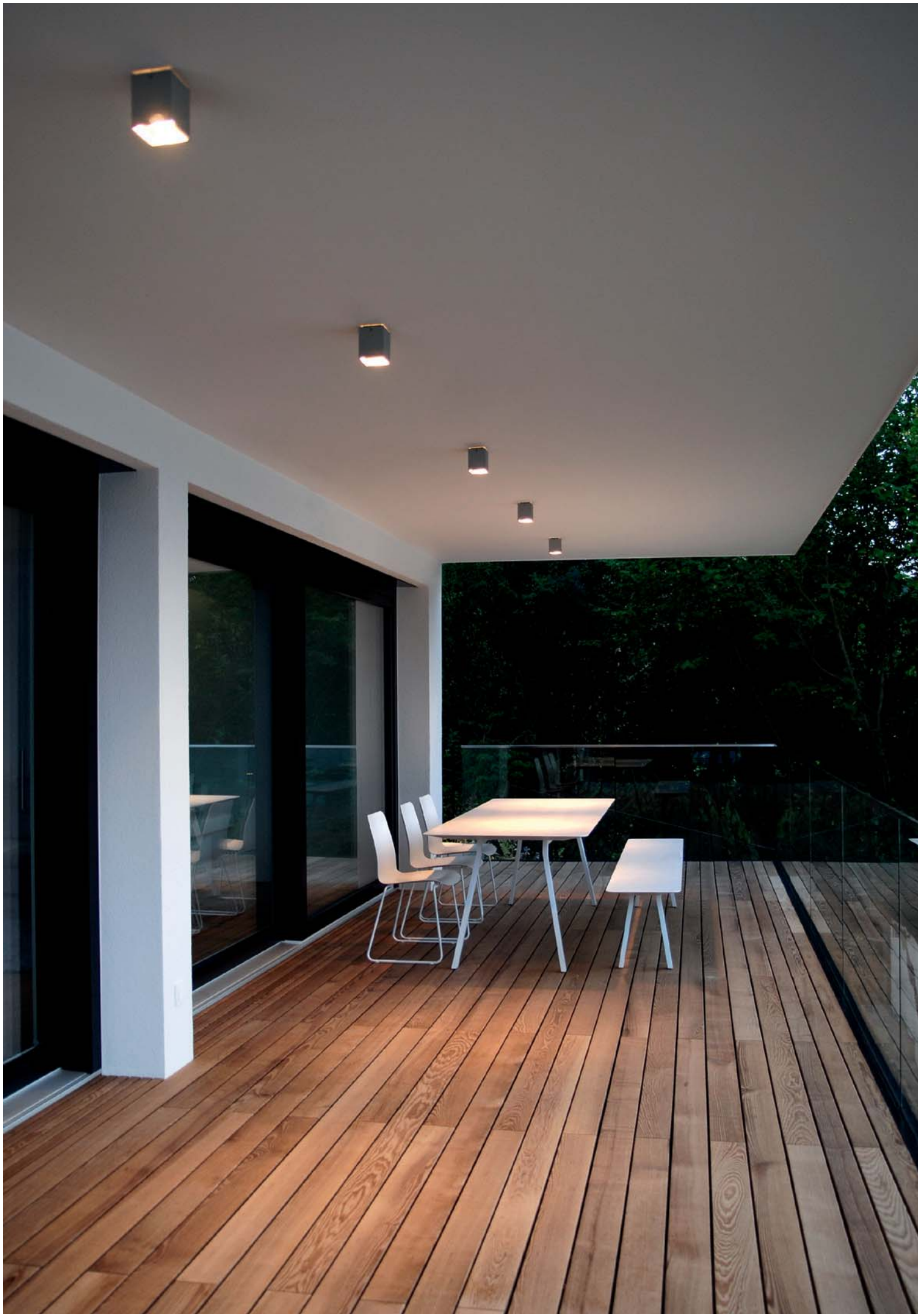

BALI S

Deckenleuchte 230 V, Gehäuse aus Aluminium, schwenkbar (2x 10°), mit tiefer gesetztem Leuchtmittel, Entblendungsring wahlweise gold oder schwarz, für LED- und Halogen-Leuchtmittel geeignet

Ceiling luminaire 230 V, housing made of aluminium, adjustable (2x 10°), with recessed illuminant, anti glare ring optionally gold or black, LED and halogen lamps are suitable

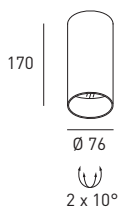
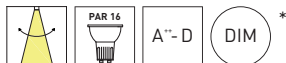

CODE	TYPE	COLOUR	LAMP	POWER SUPPLY
D324	BALI S	white/black	1xGU10 LED or 1x30W halogen	230 V
D325	BALI S	white/gold	1xGU10 LED or 1x30W halogen	230 V
D328	BALI S	black/black	1xGU10 LED or 1x30W halogen	230 V
D329	BALI S	black/gold	1xGU10 LED or 1x30W halogen	230 V

BALI

Deckenleuchte 230 V, Gehäuse aus Aluminium, schwenkbar (2x 10°), mit tiefer gesetztem Leuchtmittel, Entblendungsring wahlweise gold oder schwarz, für LED- und Halogen-Leuchtmittel geeignet

Ceiling luminaire 230 V, housing made of aluminium, adjustable (2x 10°), with recessed illuminant, anti glare ring optionally gold or black, LED and halogen lamps are suitable

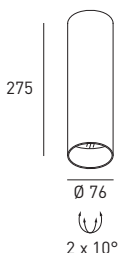
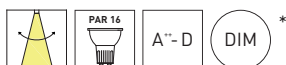

CODE	TYPE	COLOUR	LAMP	POWER SUPPLY
D314	BALI	white/black	1xGU10 LED or 1x30W halogen	230 V
D315	BALI	white/gold	1xGU10 LED or 1x30W halogen	230 V
D312	BALI	black/black	1xGU10 LED or 1x30W halogen	230 V
D313	BALI	black/gold	1xGU10 LED or 1x30W halogen	230 V

COLOURS



black/black

black/gold

white/black

white/gold

BALI L

Deckenleuchte 230 V, Gehäuse aus Aluminium, schwenkbar (2x 10°), mit tiefer gesetztem Leuchtmittel, Entblendungsring wahlweise gold oder schwarz, für LED- und Halogen-Leuchtmittel geeignet

Ceiling luminaire 230 V, housing made of aluminium, adjustable (2x 10°), with recessed illuminant, anti glare ring optionally gold or black, LED and halogen lamps are suitable

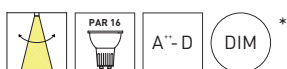
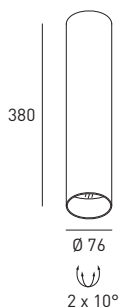

CODE	TYPE	COLOUR	LAMP	POWER SUPPLY
D908	BALI L	white/black	1xGU10 LED or 1x30W halogen	230 V
D909	BALI L	white/gold	1xGU10 LED or 1x30W halogen	230 V
D906	BALI L	black/black	1xGU10 LED or 1x30W halogen	230 V
D907	BALI L	black/gold	1xGU10 LED or 1x30W halogen	230 V



HANGING BALI

Hängeleuchte 230 V, Zylinder in drei Größen, Gehäuse aus Aluminium, schwenkbar (2 x 10°), mit tiefer gesetztem Leuchtmittel, schwarzes Stoffkabel kürzbar, Entblendungsring wahlweise gold oder schwarz, für LED- und Halogen-Leuchtmittel geeignet

Pendant 230 V, cylinder in three dimensions, housing made of aluminium, with recessed illuminant, adjustable (2 x 10°), black fabric cable may be cut to any length, anti glare ring optionally gold or black, LED and halogen lamps are suitable

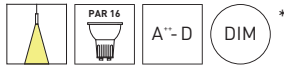
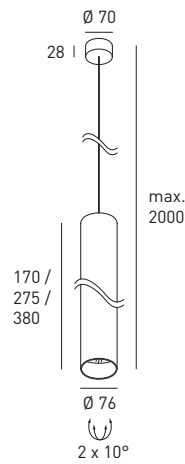

CODE	TYPE	COLOUR	LAMP	POWER SUPPLY
D359	HANGING BALI S	white/black	1xGU10 LED or 1x30W halogen	230 V
D364	HANGING BALI S	white/gold	1xGU10 LED or 1x30W halogen	230 V
D357	HANGING BALI S	black/black	1xGU10 LED or 1x30W halogen	230 V
D358	HANGING BALI S	black/gold	1xGU10 LED or 1x30W halogen	230 V
D379	HANGING BALI	white/black	1xGU10 LED or 1x30W halogen	230 V
D380	HANGING BALI	white/gold	1xGU10 LED or 1x30W halogen	230 V
D365	HANGING BALI	black/black	1xGU10 LED or 1x30W halogen	230 V
D377	HANGING BALI	black/gold	1xGU10 LED or 1x30W halogen	230 V
D904	HANGING BALI L	white/black	1xGU10 LED or 1x30W halogen	230 V
D905	HANGING BALI L	white/gold	1xGU10 LED or 1x30W halogen	230 V
D902	HANGING BALI L	black/black	1xGU10 LED or 1x30W halogen	230 V
D903	HANGING BALI L	black/gold	1xGU10 LED or 1x30W halogen	230 V

VERSIONS

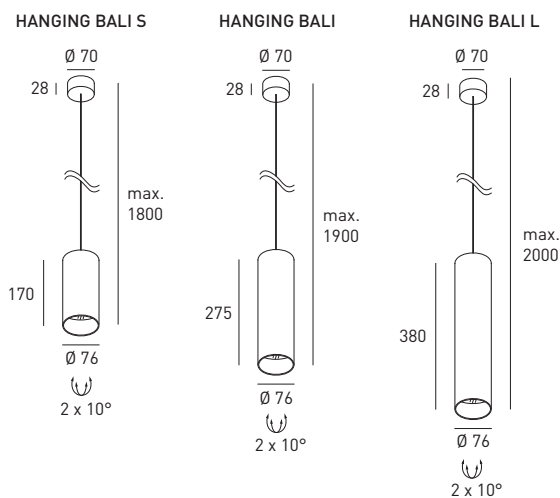

Weitere Befestigungsvarianten siehe S. 184 ff.
Further mounting versions see page 184 ff.

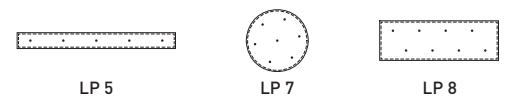

COLOURS





Architekt: Kamleitner Architekten / Foto: Andrea Ruster



Projekt: Hotel Waldruhe Kartitsch

CLEO

LED-Hängeleuchte 7 W, mit Linsenoptik, mit eingebautem Driver 230 V, dimmbar mit Phasenanschnitt-/Phasenabschrittdimmer, Gehäuse aus massivem Aluminium, schwarzes Stoffkabel kürzbar

LED-pendant 7 W, with optic lense, with built-in driver 230 V, leading edge/trailing edge dimmable, housing made of aluminium, black fabric cable may be cut to any length

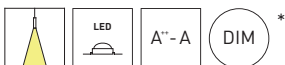
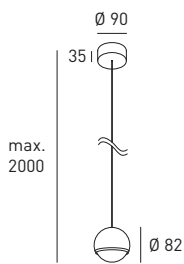

CODE	TYPE	COLOUR	LAMP	LUMEN*	POWER SUPPLY
D617	CLEO	black	1x7W LED □ 2700K	655 lm	incl. driver phase dim
D619	CLEO	brass	1x7W LED □ 2700K	655 lm	incl. driver phase dim

Weitere Befestigungsvarianten siehe S. 184 ff.
Further mounting versions see page 184 ff.

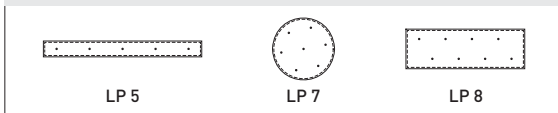



SPAGO

LED-Hängeleuchte 2 W,
Zylinder in zwei Größen,
für Aufbau- oder Einbau-
montage, extra schlanke
Bauform, mit hochwertiger
Linsenoptik, Gehäuse
aus massivem Aluminium,
Kabel kürzbar

LED-pendant 2 W, cylinder
in two dimensions,
for surface or recessed
mounting, slim design,
with high efficient optic
lense, housing made of
aluminium, cable may be
cut to any length

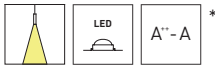

CODE	TYPE	COLOUR	LAMP	LUMEN*	POWER SUPPLY	H
756-11-20-03T	SPAGO 60 T	white	1x2W LED 40° □ 2700K	265 lm	incl. driver	
756-11-20-05T	SPAGO 60 T	black	1x2W LED 40° □ 2700K	265 lm	incl. driver	
759-11-20-03T	SPAGO 90 T	white	1x2W LED 40° □ 2700K	265 lm	incl. driver	
759-11-20-05T	SPAGO 90 T	black	1x2W LED 40° □ 2700K	265 lm	incl. driver	
CODE	TYPE	COLOUR	LAMP	LUMEN*	POWER SUPPLY	H
756-11-20-03EP	SPAGO 60 EP	white	1x2W LED 40° □ 2700K 700 mA	265 lm	excl. driver	45 mm
756-11-20-05EP	SPAGO 60 EP	black	1x2W LED 40° □ 2700K 700 mA	265 lm	excl. driver	45 mm
759-11-20-03EP	SPAGO 90 EP	white	1x2W LED 40° □ 2700K 700 mA	265 lm	excl. driver	45 mm
759-11-20-05EP	SPAGO 90 EP	black	1x2W LED 40° □ 2700K 700 mA	265 lm	excl. driver	45 mm

H = Einbautiefe / recessed depth

VERSIONS

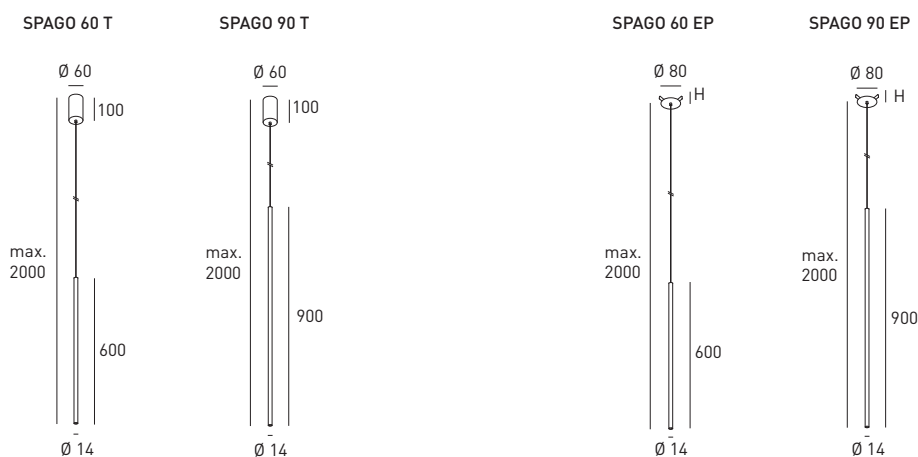

Weitere Befestigungsvarianten siehe S. 184 ff.
Further mounting versions see page 184 ff.



Driver siehe Seite 195 ff. / Driver see page 195 ff.

** Deckenstärke < 5 mm = Ausschnitt 50 mm / ** Ceiling dimension < 5 mm = Cut out 50 mm

* Technische Informationen siehe Seite 189 / Lumenangaben sind Nominalwerte - * Technical information see page 189 / Lumen data are nominal data

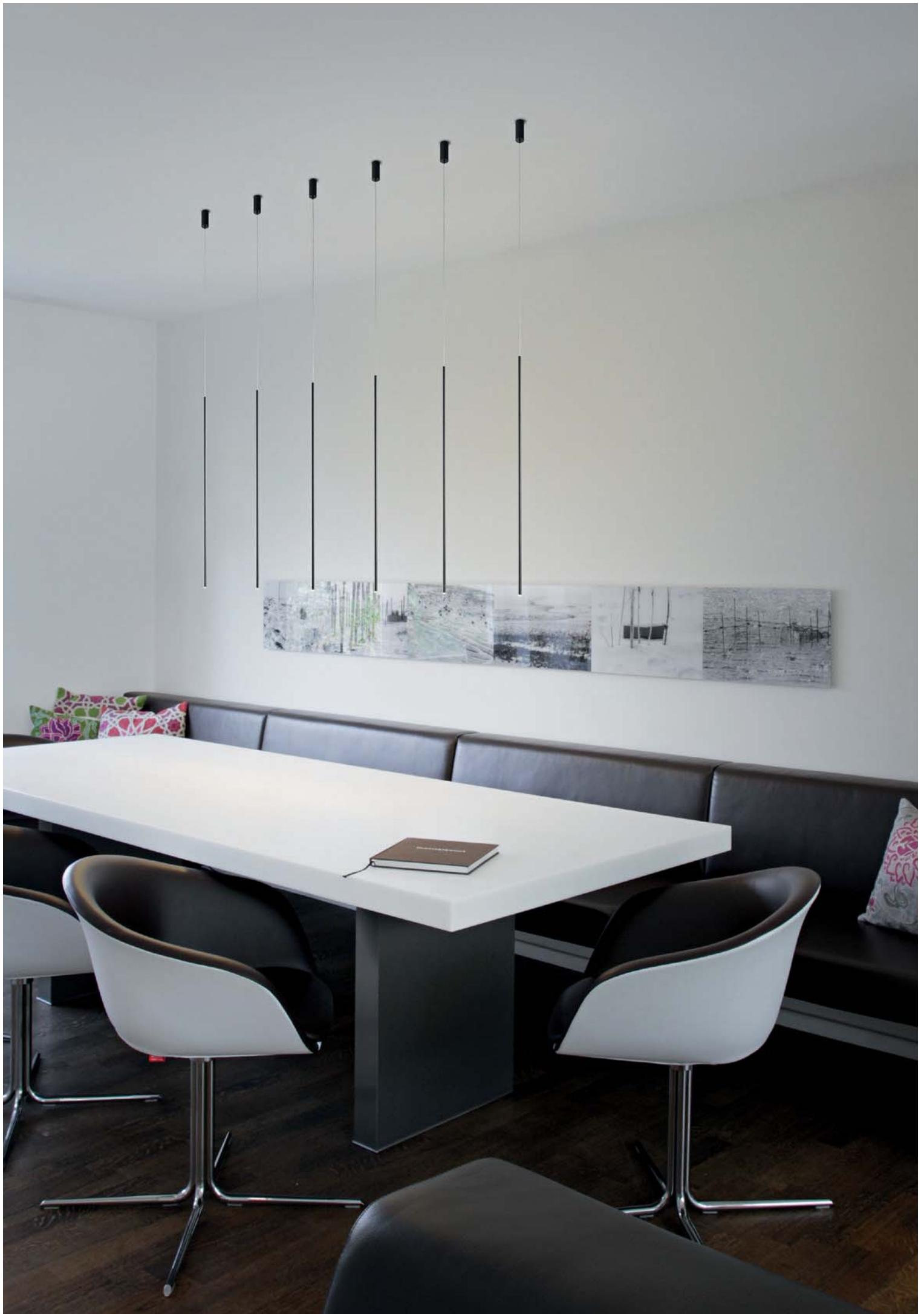

SPAGO KOMBINATIONEN / SPAGO COMBINATIONS

Weitere Anwendungsbeispiele mit den Befestigungsvarianten LP 5, LP 7, LP 8 und STAR für SPAGO Hängeleuchten, siehe S. 184 f.
Further application examples with mounting options LP 5, LP 7, LP 8 und STAR for SPAGO pendants, see also page 184 f.

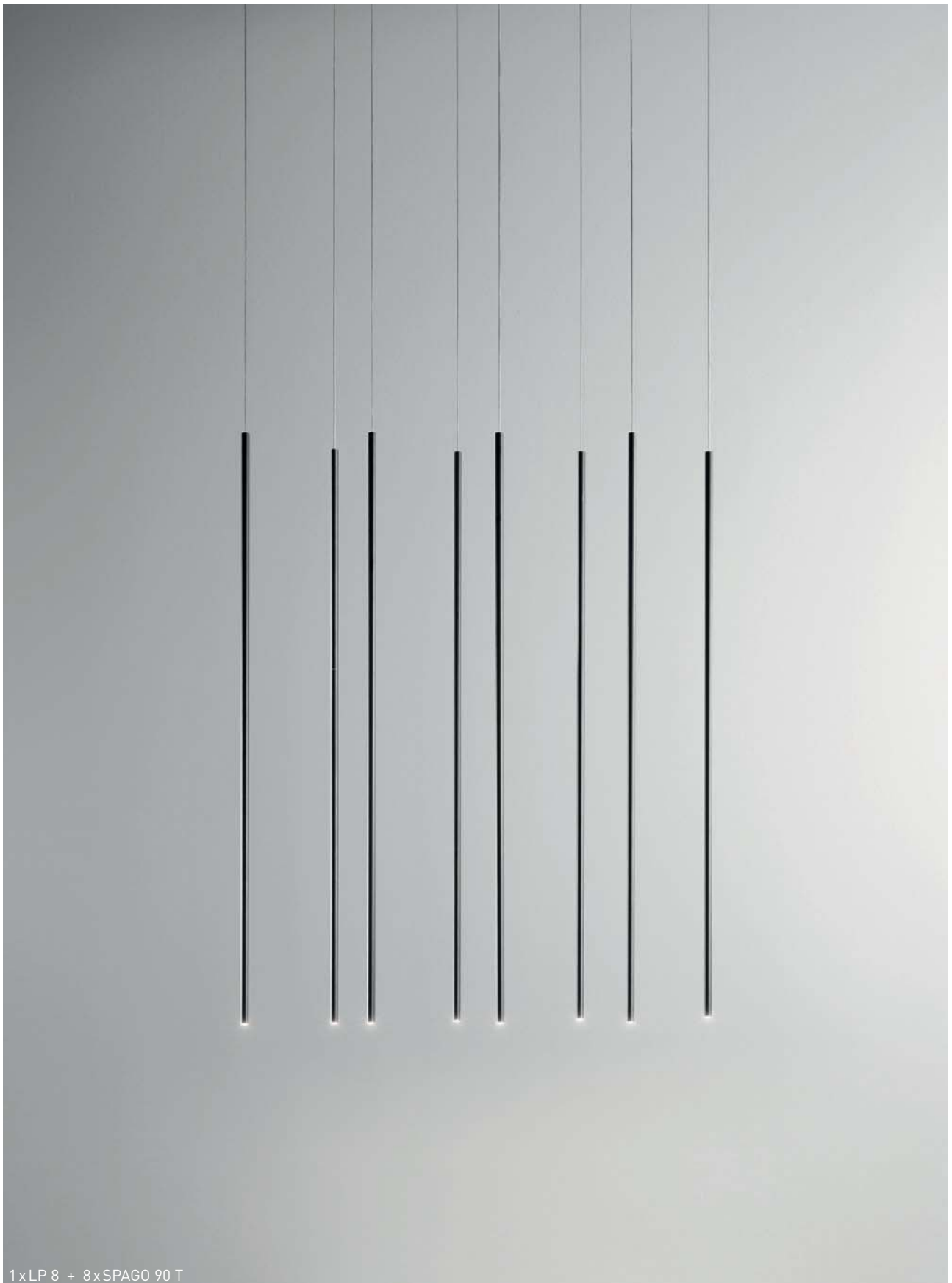

1xLP 8 + 8xSPAGO 90 T

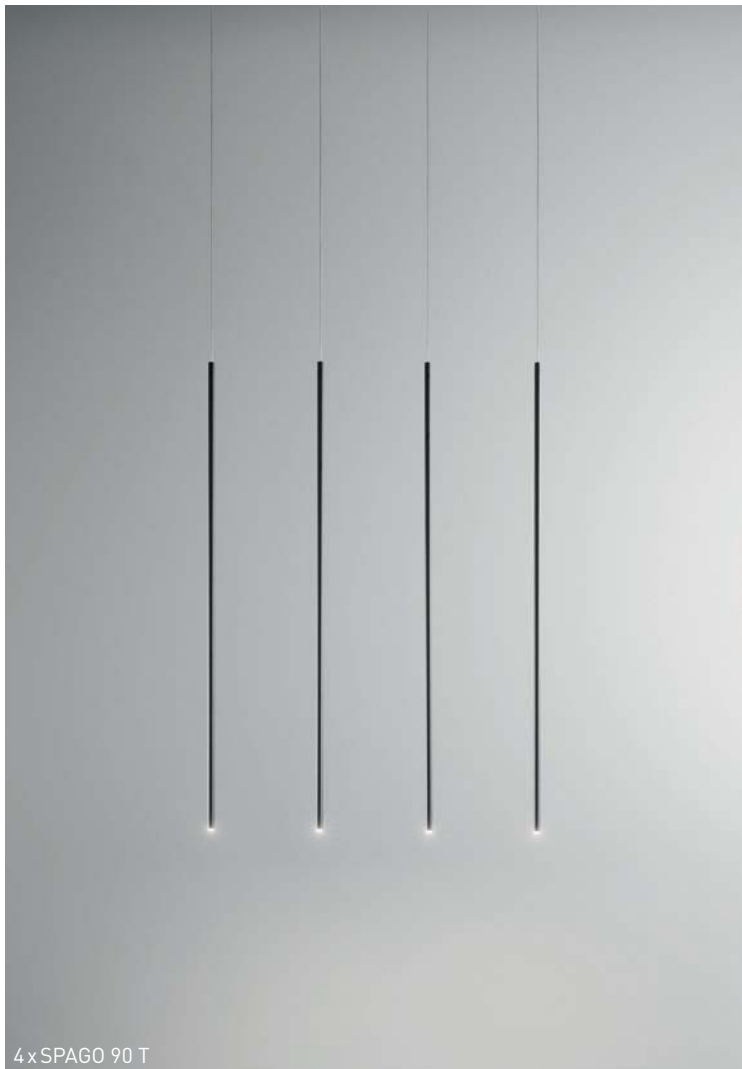

4 x SPAGO 90 T

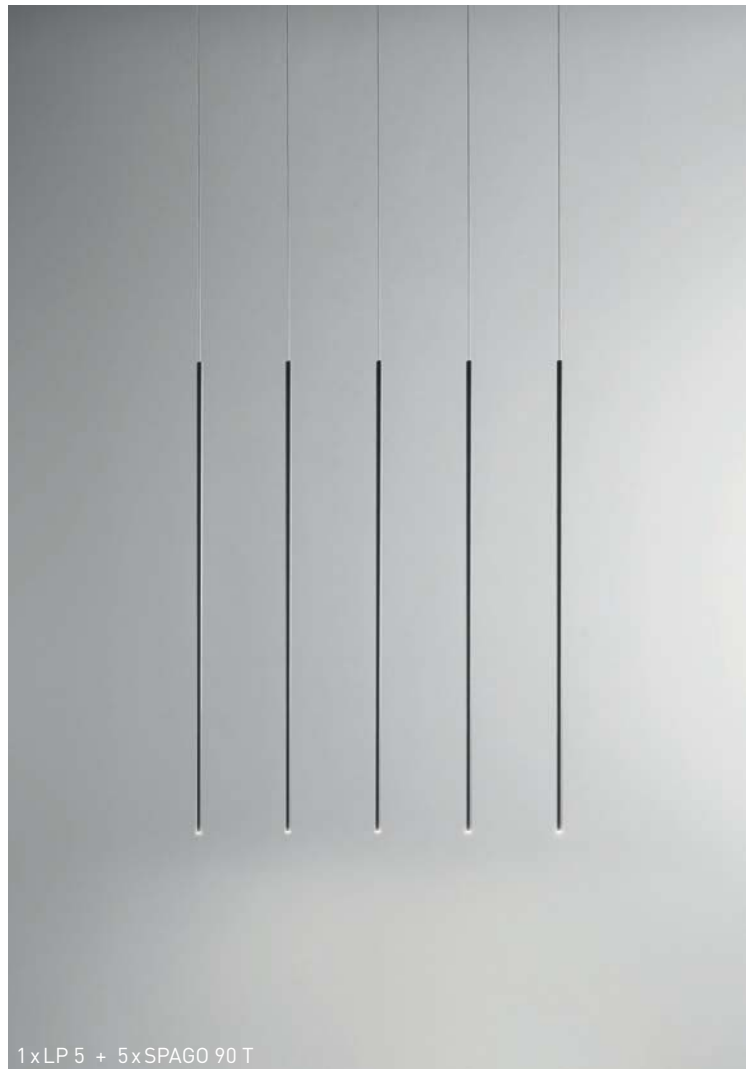

1 x LP 5 + 5 x SPAGO 90 T

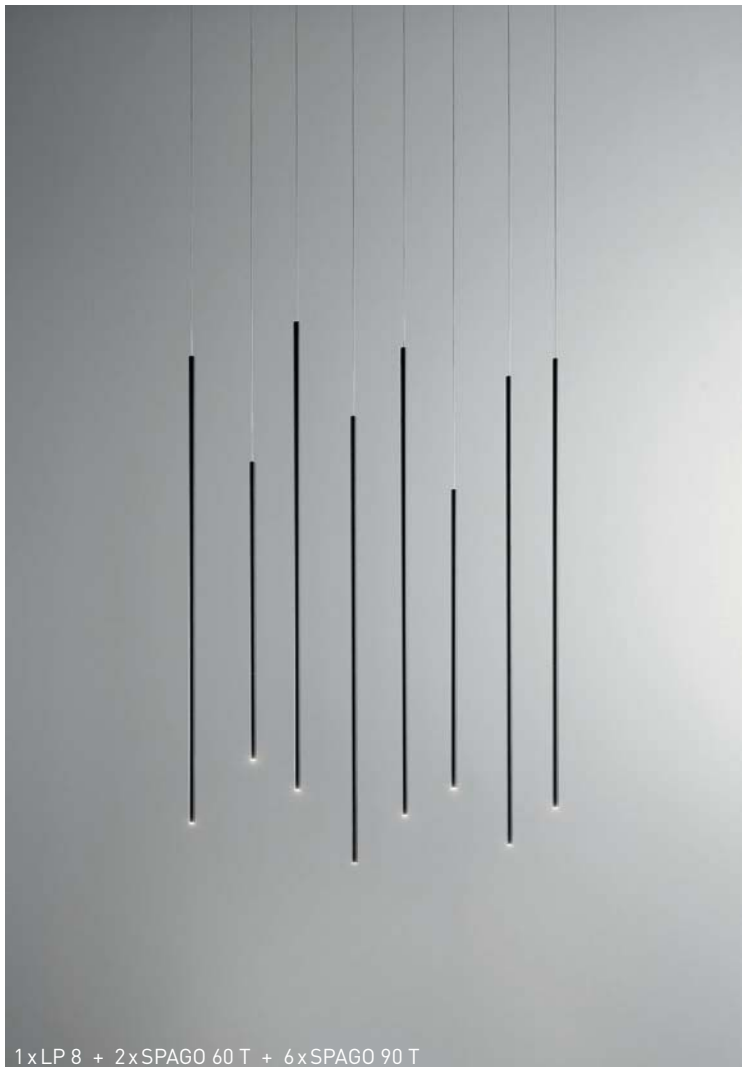

1 x LP 8 + 2 x SPAGO 60 T + 6 x SPAGO 90 T



1 x STAR + 2 x SPAGO 60 T + 4 x SPAGO 90 T

LILLI

LED-Hängeleuchte 7 W, CRI>90, mit eingebautem Driver 230 V, Gehäuse aus massivem Aluminium, optional dimmbar mit Phasenanschnitt-/Phasenabschnittdimmer, mit Entblendungskonus, Kabel kürzbar

LED-pendant 7 W, CRI>90, with built-in driver 230 V, housing made of aluminium, optionally leading edge/trailing edge dimmable, with anti glare cone, cable may be cut to any length

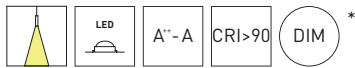
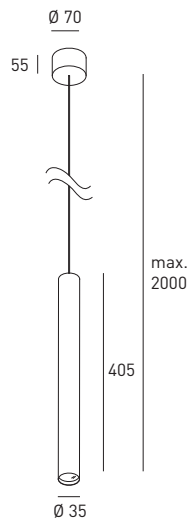

CODE	TYPE	COLOUR	LAMP	LUMEN*	POWER SUPPLY
D255	LILLI	white	1x7W LED 33° □ 3000K	730 lm	incl. driver
D255dim	LILLI	white	1x7W LED 33° □ 3000K	730 lm	incl. driver phase dim

Weitere Befestigungsvarianten siehe Seite 184 ff. / Further mounting versions see page 184 ff.

* Technische Informationen siehe Seite 189 / Lumenangaben sind Nominalwerte - * Technical information see page 189 / Lumen data are nominal data

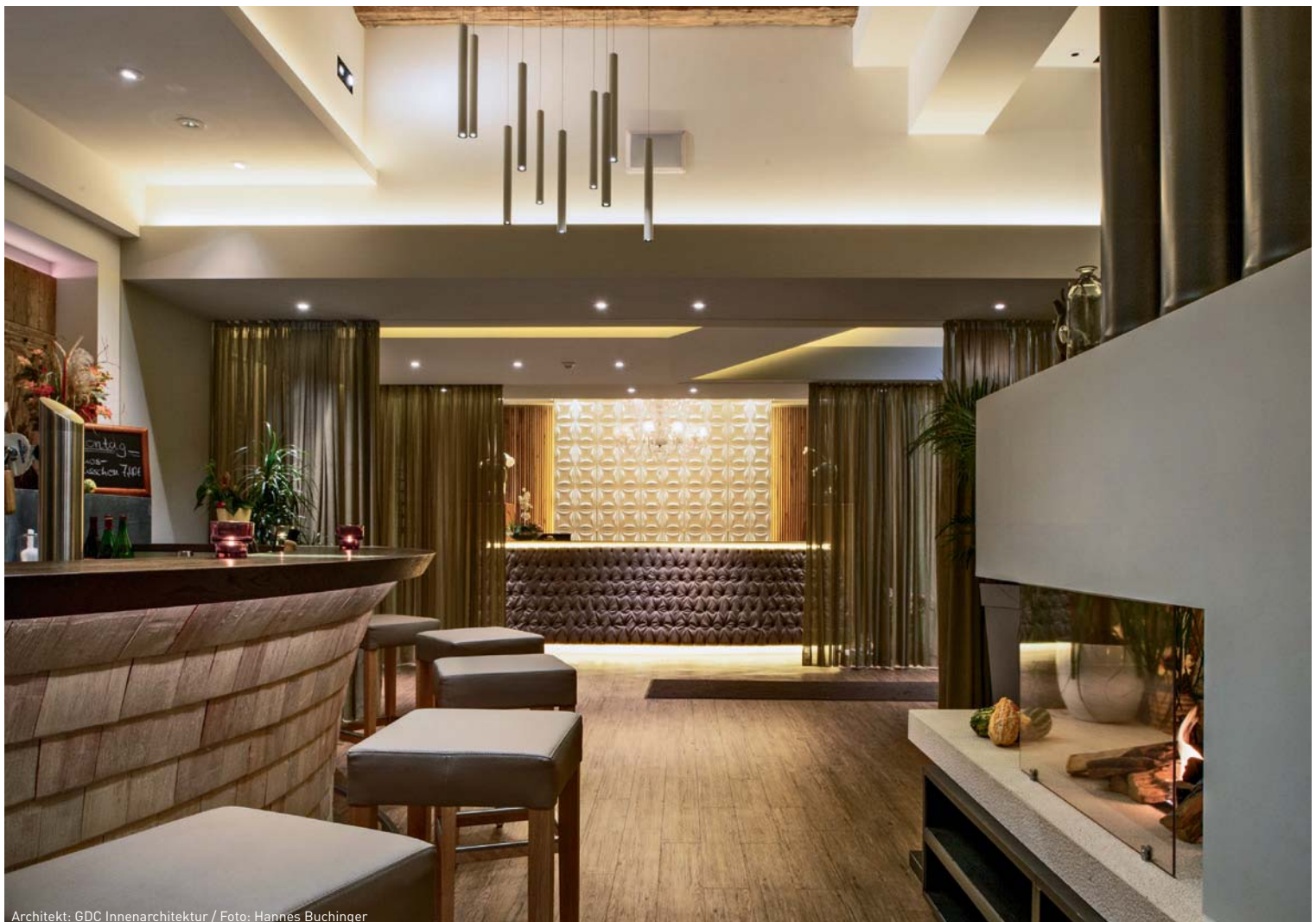

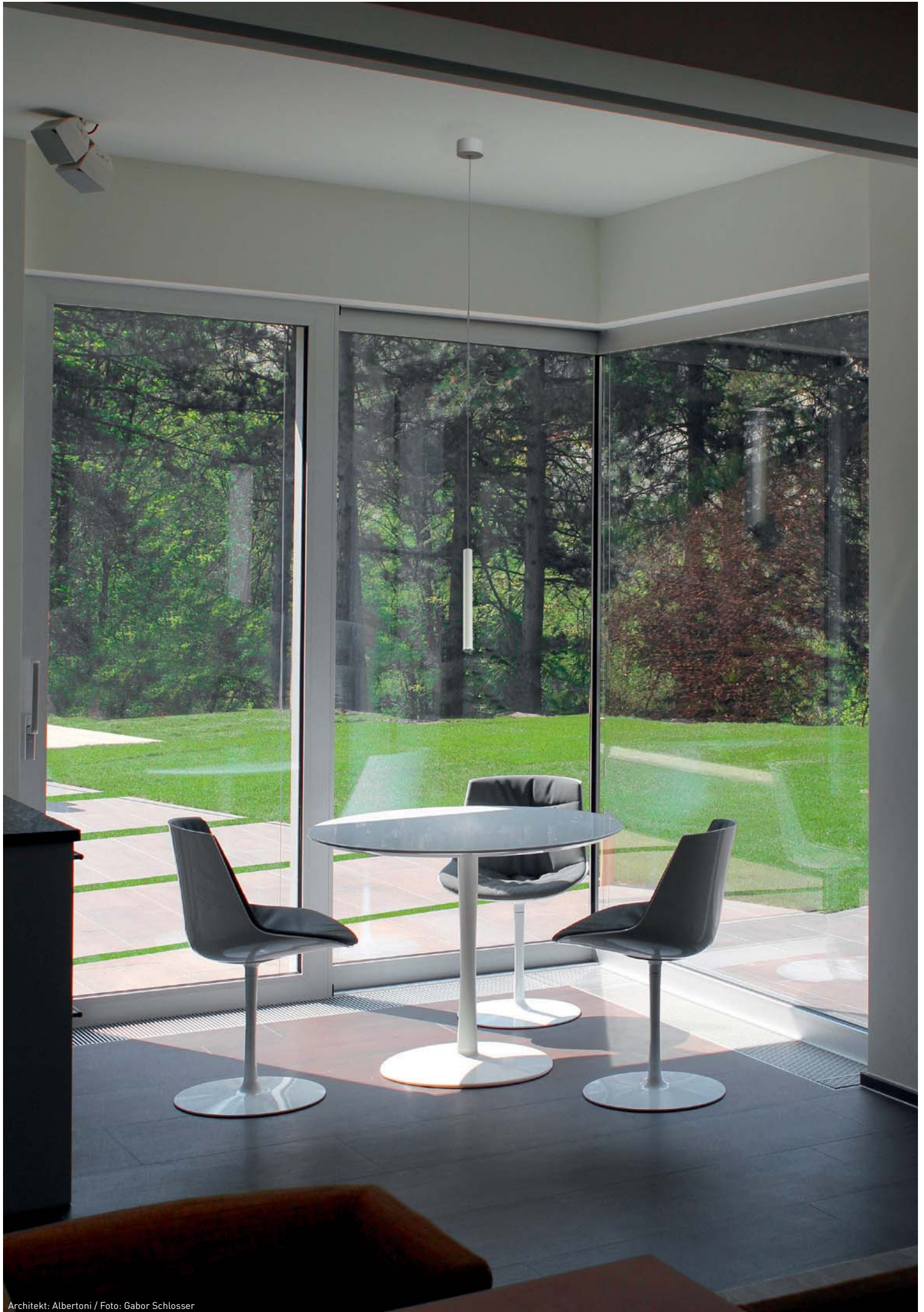

ORBIT 1

LED-Wandleuchte 4 W, CRI>90, mit eingebautem Driver 230 V, Gehäuse aus massivem Aluminium, für Indirektbeleuchtung

LED-wall luminaire 4 W, CRI>90, with built-in driver 230 V, housing made of aluminium, for indirect lighting,

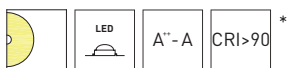
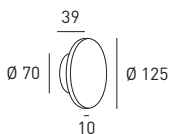

CODE	TYPE	COLOUR	LAMP	LUMEN*	POWER SUPPLY
D508	ORBIT 1	black	4W LED □ 2700K	335 lm	incl. driver

ORBIT 2

LED-Wandleuchte 7,5 W, CRI>90, mit eingebautem Driver 230 V, Gehäuse aus massivem Aluminium, für Indirektbeleuchtung

LED-wall luminaire 7,5 W, CRI>90, with built-in driver 230 V, housing made of aluminium, for indirect lighting,

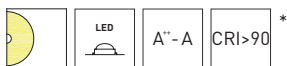
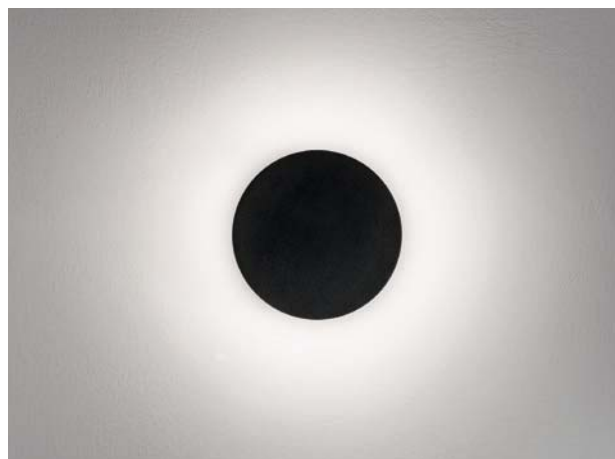
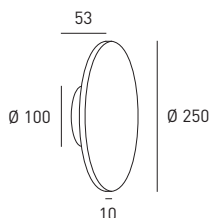

CODE	TYPE	COLOUR	LAMP	LUMEN*	POWER SUPPLY
D510	ORBIT 2	black	7,5W LED □ 2700K	660 lm	incl. driver

ORBIT 3

LED-Wandleuchte 7,5 W, CRI>90, mit eingebautem Driver 230 V, Gehäuse aus massivem Aluminium, für Indirektbeleuchtung, 360° drehbares Lichtelement für unterschiedliche Designvariationen

LED-wall luminaire 7,5 W, CRI>90, with built-in driver 230 V, housing made of aluminium, for indirect lighting, , lighting element 360° swiveling for different designs

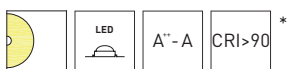
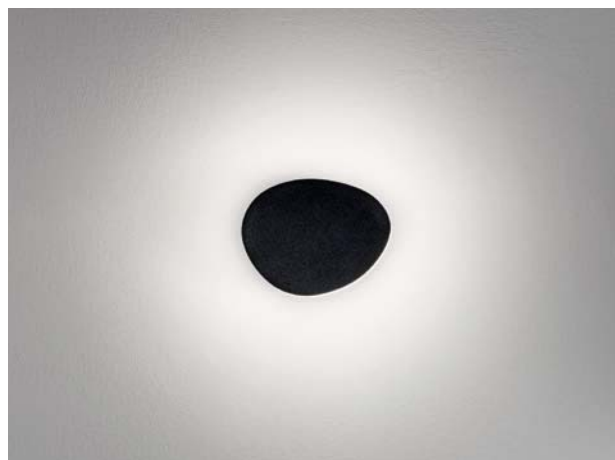
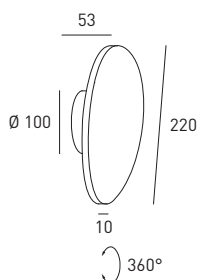

CODE	TYPE	COLOUR	LAMP	LUMEN*	POWER SUPPLY
D512	ORBIT 3	black	7,5W LED □ 2700K	660 lm	incl. driver

ORBIT 4

LED-Wandleuchte 7,5 W, CRI>90, mit eingebautem Driver 230 V, Gehäuse aus massivem Aluminium, für Indirektbeleuchtung, 360° drehbares Lichtelement für unterschiedliche Designvariationen

LED-wall luminaire 7,5 W, CRI>90, with built-in driver 230 V, housing made of aluminium, for indirect lighting, , lighting element 360° swiveling for different designs

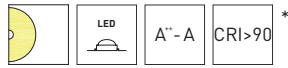
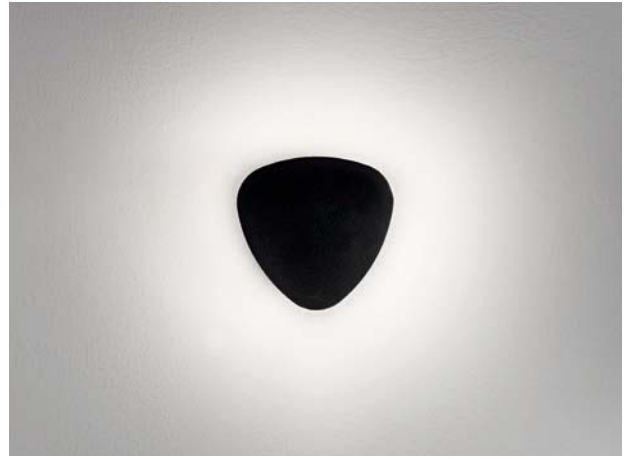
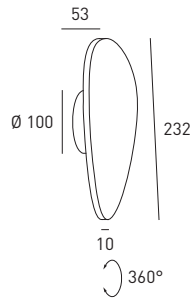

CODE	TYPE	COLOUR	LAMP	LUMEN*	POWER SUPPLY
D514	ORBIT 4	black	7,5W LED □ 2700K	660 lm	incl. driver



Zwei unterschiedliche Bauhöhen ermöglichen eine überlappende Montage (ORBIT 1 und ORBIT 2)

Two different sizes allow overlapping mounting (ORBIT 1 and ORBIT 2)

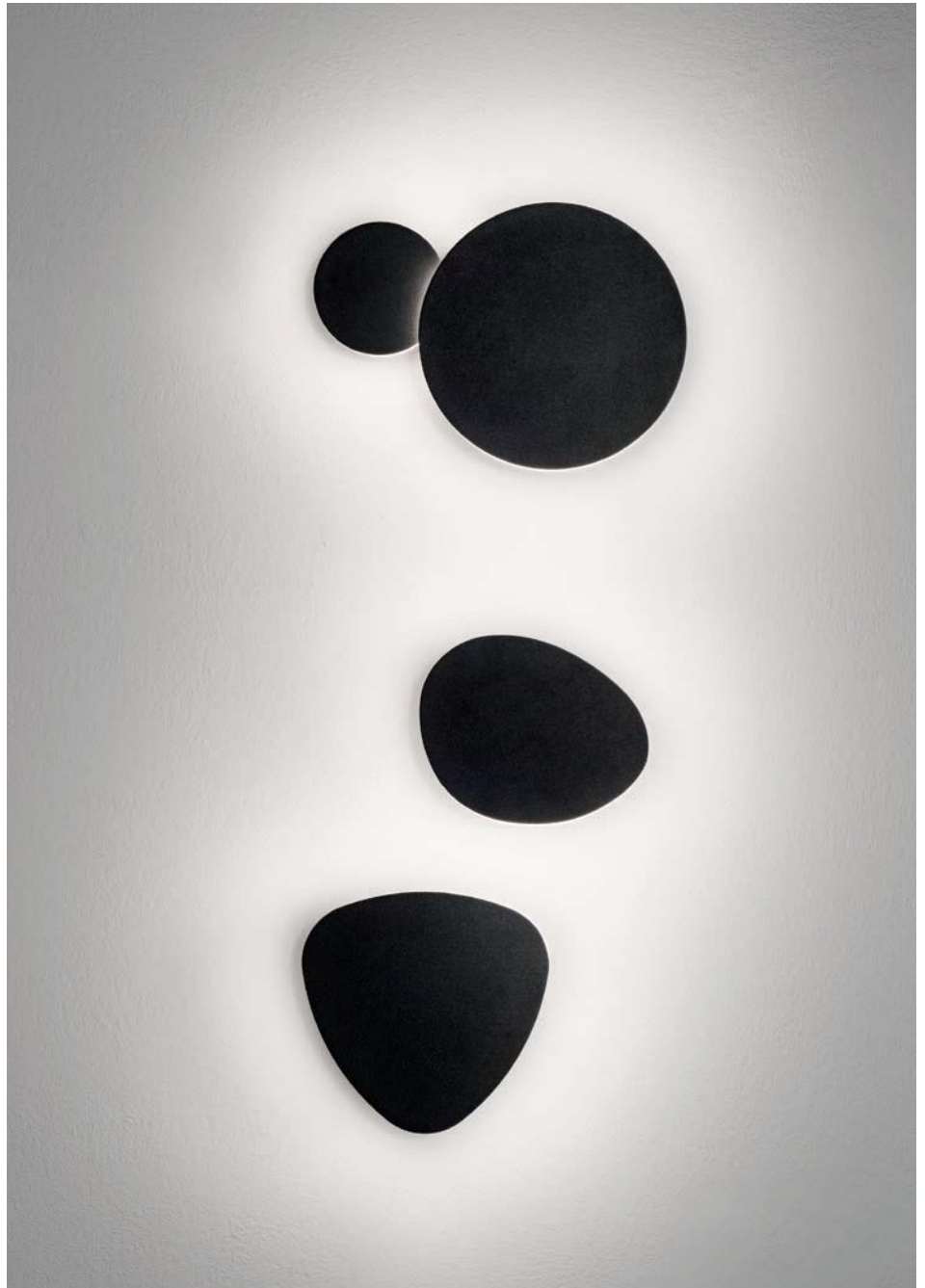

BRICK 15

Wandleuchte 230 V, für LED- und Halogen-Leuchtmittel oder LED 9 W, CRI>90, mit eingebautem Driver, dimmbar mit Phasenanschnitt-/Phasenabschrittdimmer, für Direkt- und Indirektbeleuchtung

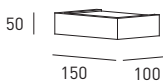

Wall luminaire 230 V, for LED and halogen lamps or LED 9 W, CRI>90, with built-in driver, leading edge/trailing edge dimmable, for direct and indirect lighting

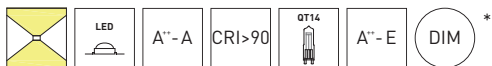

CODE	TYPE	COLOUR	LAMP	LUMEN*	POWER SUPPLY
D757	BRICK 15 LED	white	9W LED □ 2700K	960 lm	incl. driver phase dim
D759	BRICK 15 LED	chrome	9W LED □ 2700K	960 lm	incl. driver phase dim
D355	BRICK 15	white	1xG9 LED or 1x48W halogen	-	230 V
D303	BRICK 15	grey	1xG9 LED or 1x48W halogen	-	230 V
D301	BRICK 15	chrome	1xG9 LED or 1x48W halogen	-	230 V

BRICK 30

Wandleuchte 230 V, für LED- und Halogen-Leuchtmittel oder LED 18 W, CRI>90, mit eingebautem Driver, dimmbar mit Phasenanschnitt-/Phasenabschrittdimmer, für Direkt- und Indirektbeleuchtung

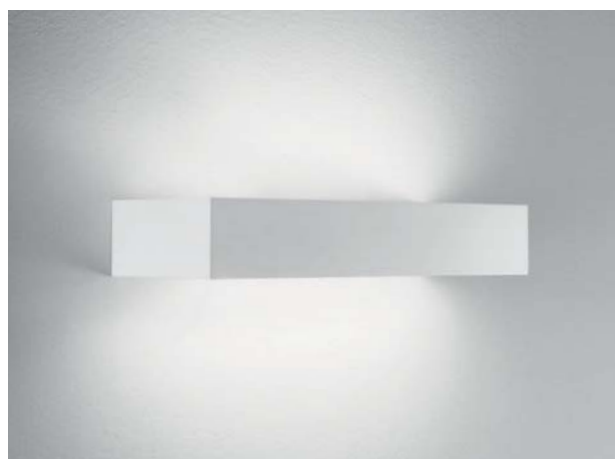
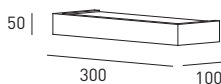

Wall luminaire 230 V, for LED and halogen lamps or LED 18 W, CRI>90, with built-in driver, leading edge/trailing edge dimmable, for direct and indirect lighting

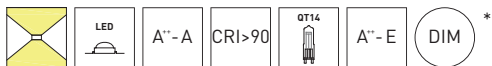

CODE	TYPE	COLOUR	LAMP	LUMEN*	POWER SUPPLY
D756	BRICK 30 LED	white	18W LED □ 2700K	1920 lm	incl. driver phase dim
D758	BRICK 30 LED	chrome	18W LED □ 2700K	1920 lm	incl. driver phase dim
D356	BRICK 30	white	3xG9 LED or 3x48W halogen	-	230 V
D304	BRICK 30	grey	3xG9 LED or 3x48W halogen	-	230 V
D302	BRICK 30	chrome	3xG9 LED or 3x48W halogen	-	230 V

* Technische Informationen siehe Seite 189 / Lumenangaben sind Nominalwerte - * Technical information see page 189 / Lumen data are nominal data



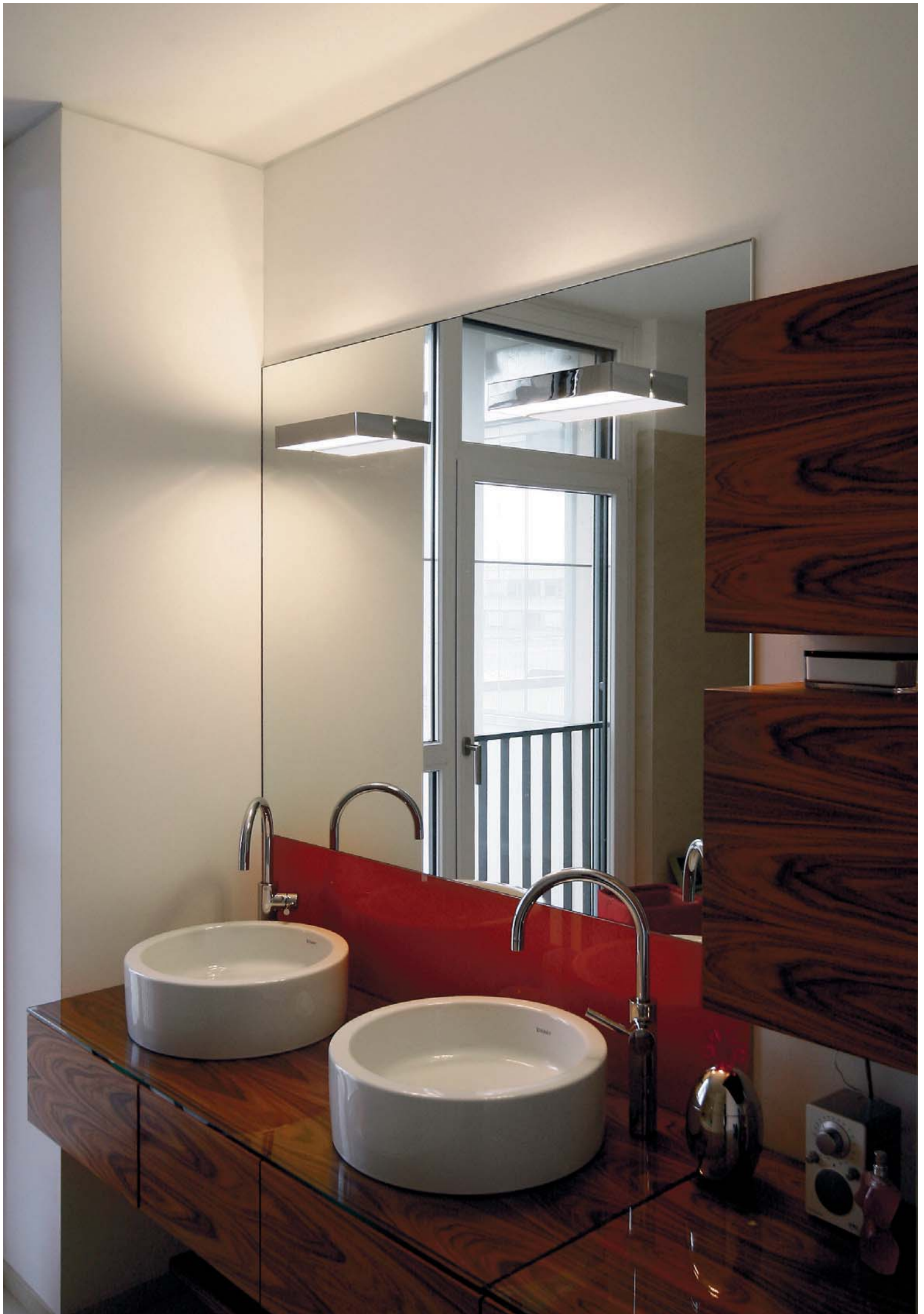

SUPREME

LED-Wand- und Deckenleuchte 10 W, 14 W und 18 W, mit Acrylglasabdeckung und eingebautem Driver 230 V, IP44

LED-wall and ceiling luminaire 10 W, 14 W and 18 W, with acrylic glass cover and built-in driver 230 V, IP44

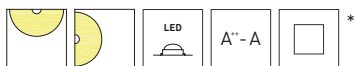
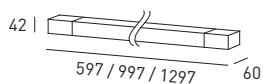

CODE	TYPE	COLOUR	LAMP	LUMEN*	POWER SUPPLY
D673	SUPREME 60	polished stainless steel	10W LED □ 3000K	1305 lm	incl. driver
D678	SUPREME 100	polished stainless steel	14W LED □ 3000K	1660 lm	incl. driver
D680	SUPREME 130	polished stainless steel	18W LED □ 3000K	2135 lm	incl. driver

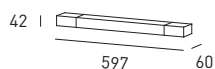

SUPREME 60

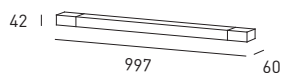

SUPREME 100

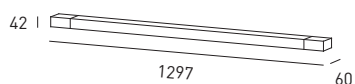

SUPREME 130



SUN

LED-Wand- und Deckenleuchte 230 V, mit 18 W AC-LED, Gehäuse aus Aluminiumdruckguss, für Indirektbeleuchtung

LED-wall and ceiling luminaire 230 V, with 18 W AC-LED, housing made of die-cast aluminium, for indirect lighting

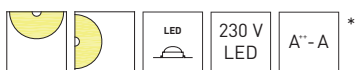
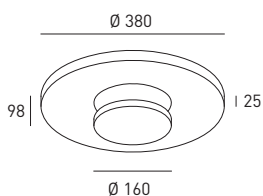

CODE	TYPE	COLOUR	LAMP	LUMEN*	POWER SUPPLY
D819	SUN	white	18W LED \square 3000K	1180 lm	230 V



GINGER

LED-Wandleuchte 7 W, CRI>90, mit eingebautem Driver 230 V, Gehäuse aus massivem Aluminium, dimmbar mit Phasenanschnitt-/Phasenabschnittdimmer, für Direkt- und Indirektbeleuchtung

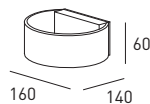

LED-wall luminaire 7 W, CRI>90, with built-in driver 230 V, housing made of aluminium, leading edge/trailing edge dimmable, for direct and indirect lighting

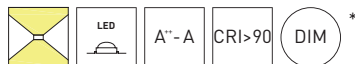

CODE	TYPE	COLOUR	LAMP	LUMEN*	POWER SUPPLY
D986	GINGER	white	1x7W LED □ 2700K	760 lm	incl. driver phase dim
D286	GINGER	white	1x7W LED □ 3000K	810 lm	incl. driver phase dim

MIAMI

LED-Wandleuchte 7 W mit eingebautem Driver 230 V, Gehäuse aus stranggepresstem Aluminium, dimmbar mit Phasenanschnitt-/Phasenabschnittdimmer, für Direkt- und Indirektbeleuchtung, für den Innen- und Außenbereich verwendbar, IP54

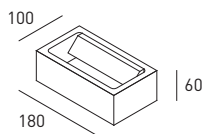

LED-wall luminaire 7 W with built-in driver 230 V, housing made of extruded aluminium, leading edge/trailing edge dimmable, for direct and indirect lighting, to be used in indoor and outdoor areas, IP54

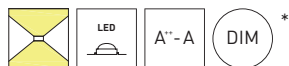

IP54

CODE	TYPE	COLOUR	LAMP	LUMEN*	POWER SUPPLY
D204	MIAMI	white	7W LED □ 3000K	695 lm	incl. driver phase dim
D608	MIAMI	black	7W LED □ 3000K	695 lm	incl. driver phase dim

HENRY

LED-Wandleuchte 9,5 W, CRI>90, mit eingebautem Driver 230 V, optional dimmbar mit Phasenanschnitt-/Phasenabschnittdimmer, Gehäuse aus massivem Aluminium, für Direkt- und Indirektbeleuchtung

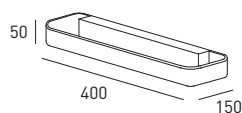

LED-wall luminaire 9,5 W, CRI>90, with built-in driver 230 V, optionally leading edge/trailing edge dimmable, housing made of aluminium, for direct and indirect lighting

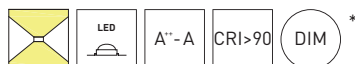

CODE	TYPE	COLOUR	LAMP	LUMEN*	POWER SUPPLY
D288	HENRY	white	9,5W LED □ 3000K	995 lm	incl. driver
D439	HENRY dim	white	9,5W LED □ 3000K	995 lm	incl. driver phase dim



Architekt: Kamleitner Architekten / Foto: Andrea Ruster



CHARME

LED-Wandleuchte 2x3 W
Gehäuse aus Gips, mit Wand-
farbe überstreichbar, mit
eingebautem Driver 230 V,
für Direkt- und Indirekt-
beleuchtung

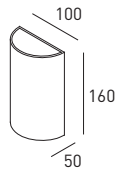

LED-wall luminaire 2x3 W
housing made of plaster,
paintable with wall colour,
with built-in driver 230 V,
for direct and indirect
lighting

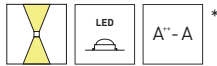

CODE	TYPE	COLOUR	LAMP	LUMEN*	POWER SUPPLY
D285	CHARME	white	2x3W LED 3000K	2x150 lm	incl. driver

VERONA

LED-Wandleuchte 2x3 W
Gehäuse aus Gips, mit Wand-
farbe überstreichbar, mit
eingebautem Driver 230 V,
für Direkt- und Indirekt-
beleuchtung

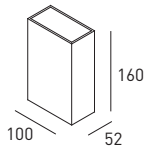

LED-wall luminaire 2x3 W
housing made of plaster,
paintable with wall colour,
with built-in driver 230 V,
for direct and indirect
lighting

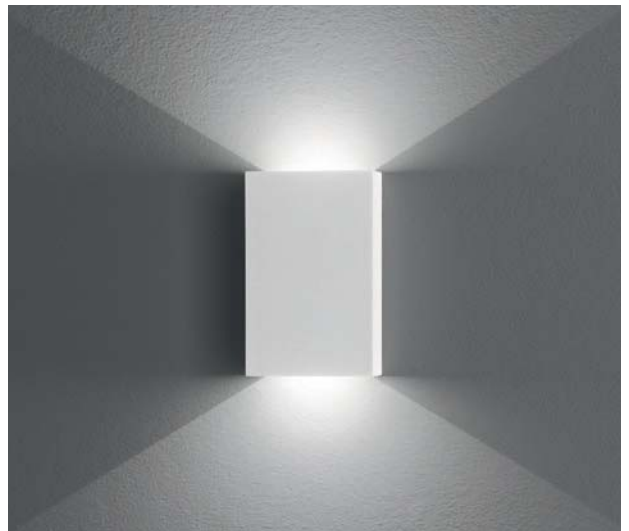
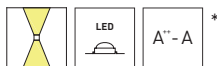

CODE	TYPE	COLOUR	LAMP	LUMEN*	POWER SUPPLY
D299	VERONA	white	2x3W LED 3000K	2x150 lm	incl. driver

ROY

Wandleuchte 230 V, Gehä-
use aus stranggepresstem
Aluminium, für Direkt- und
Indirektbeleuchtung, für
LED- und Halogen-Leucht-
mittel geeignet

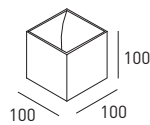

Wall luminaire 230 V,
housing made of extruded
aluminium, for direct and
indirect lighting, LED and
halogen lamps are suitable

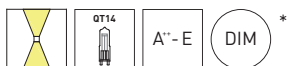

CODE	TYPE	COLOUR	LAMP	POWER SUPPLY
D309	ROY	white	1xG9 LED or 1x48W halogen	230 V
D308	ROY	grey	1xG9 LED or 1x48W halogen	230 V



FEELING

LED-Wandleuchte 2x3 W mit eingebautem Driver 230 V, Innenteil gold, für Direkt- und Indirektbeleuchtung

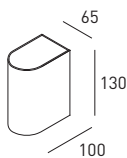

LED-wall luminaire 2x3 W with built-in driver 230 V, inside gold, for direct and indirect lighting

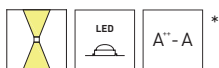

CODE	TYPE	COLOUR	LAMP	LUMEN*	POWER SUPPLY
D784	FEELING	black/gold	2x3W LED □ 3000K	2x150 lm	incl. driver

HANG ON

LED-Wandleuchte 6 W, mit eingebautem Driver 230 V, Gehäuse aus massivem Aluminium, dimmbar mit Phasenanschnitt-/Phasenabschnittdimmer, für Indirektbeleuchtung

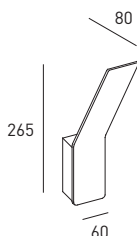

LED-wall luminaire 6 W, with built-in driver 230 V, housing made of aluminium, leading edge/trailing edge dimmable, for indirect lighting

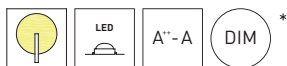

CODE	TYPE	COLOUR	LAMP	LUMEN*	POWER SUPPLY
D287	HANG ON	white	1x6W LED □ 3000K	550 lm	incl. driver phase dim



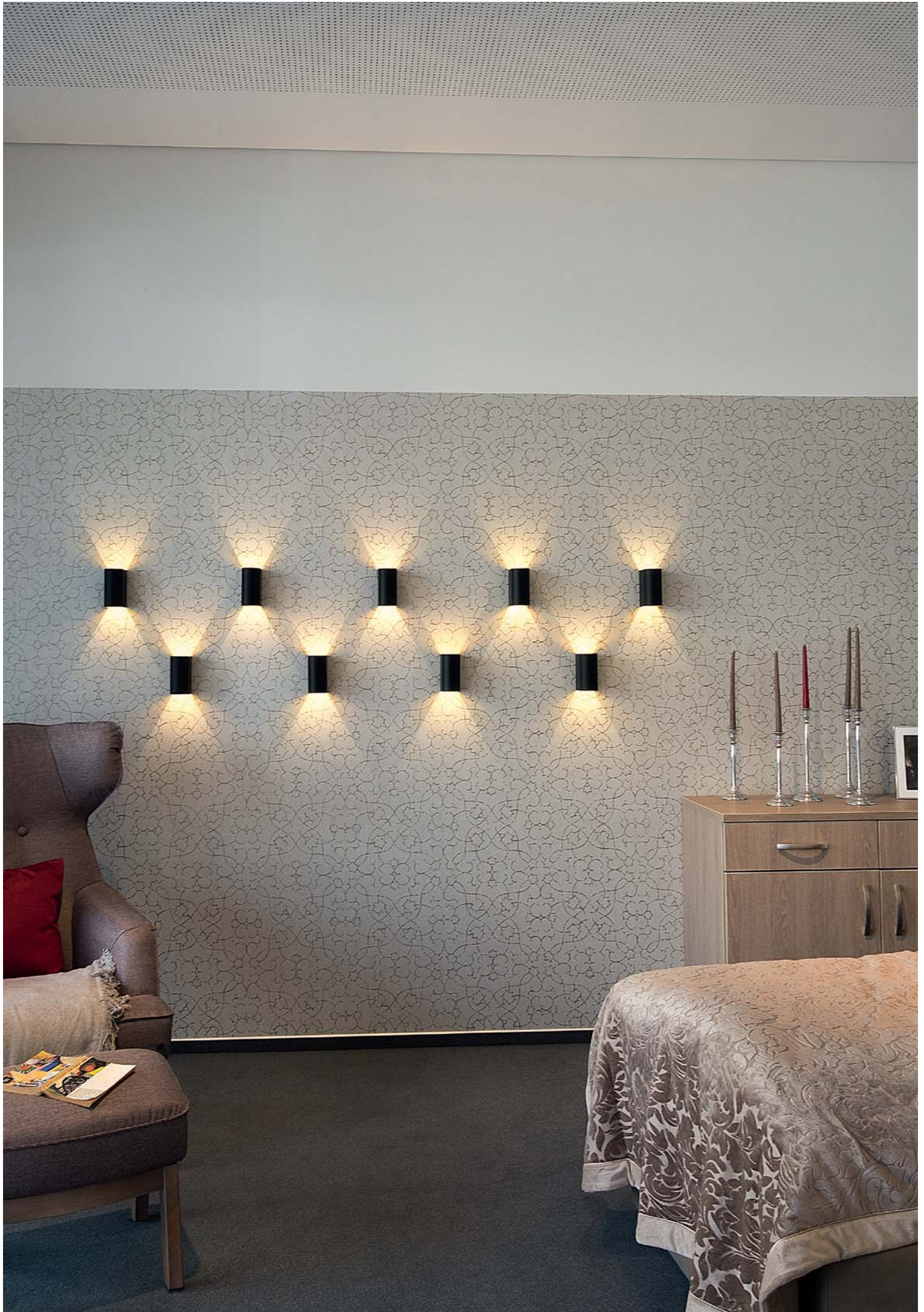

GINO

LED-Wandleuchte 1 x 6 W, CRI>90, mit eingebautem Driver 230 V, Gehäuse aus stranggepresstem Aluminium, dimmbar mit Phasenschnitt-/Phasenabschnitt-dimmer, für Direkt- und Indirektbeleuchtung

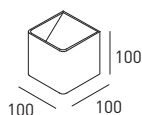

LED-wall luminaire 1 x 6 W, CRI>90, with built-in driver 230 V, housing made of extruded aluminium, leading edge/trailing edge dimmable, for direct and indirect lighting



CODE	TYPE	COLOUR	LAMP	LUMEN*	POWER SUPPLY
D645	GINO	white	1x6W LED 2700K	450 lm	incl. driver phase dim
D647	GINO	black	1x6W LED 2700K	450 lm	incl. driver phase dim
D245	GINO	white	1x6W LED 3000K	470 lm	incl. driver phase dim
D646	GINO	black	1x6W LED 3000K	470 lm	incl. driver phase dim

SATIS

LED-Wandleuchte 1 x 6 W, CRI>90, mit eingebautem Driver 230 V, Gehäuse aus stranggepresstem Aluminium, mit asymmetrischem Lichtaustritt, für Direkt- und Indirektbeleuchtung

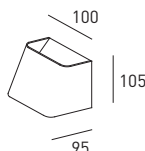

LED-wall luminaire 1 x 6 W, CRI>90, with built-in driver 230 V, housing made of extruded aluminium, with asymmetrical light emission, for direct and indirect lighting

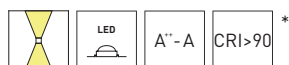

CODE	TYPE	COLOUR	LAMP	LUMEN*	POWER SUPPLY
D205	SATIS	white	1x6W LED 3000K	470 lm	incl. driver

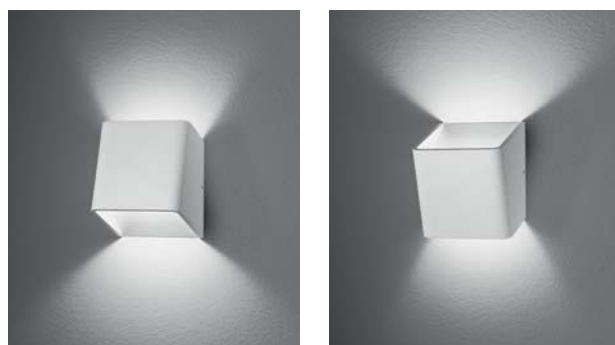

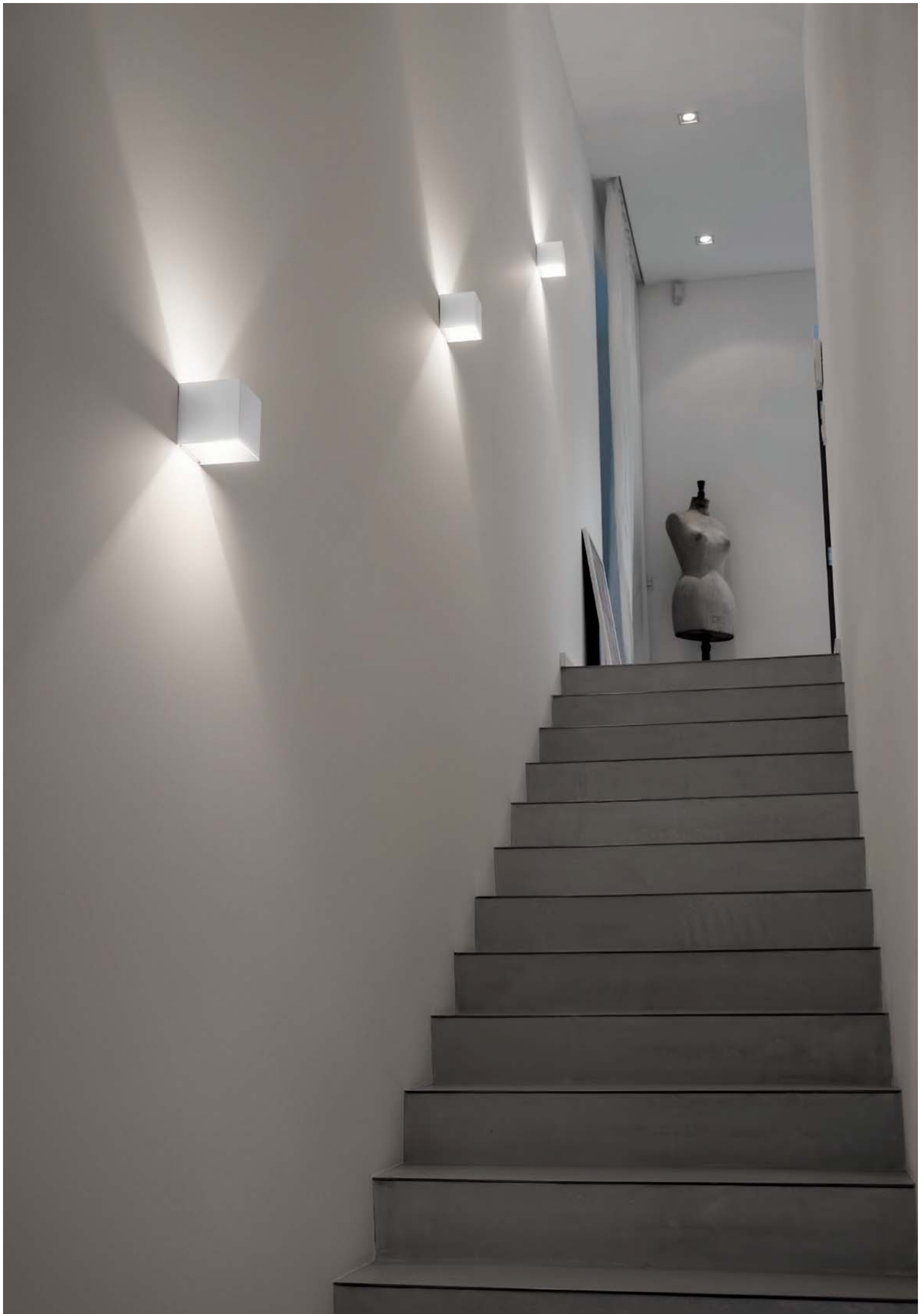

SECRET

LED-Wandleuchte 2x3 W, CRI>90, mit eingebautem Driver 230 V, Gehäuse aus stranggepresstem Aluminium, dimmbar mit Phasenanschnitt-/Phasenabschnitt-dimmer, für Direkt- und Indirektbeleuchtung, für den Innen- und Außenbereich verwendbar, IP54

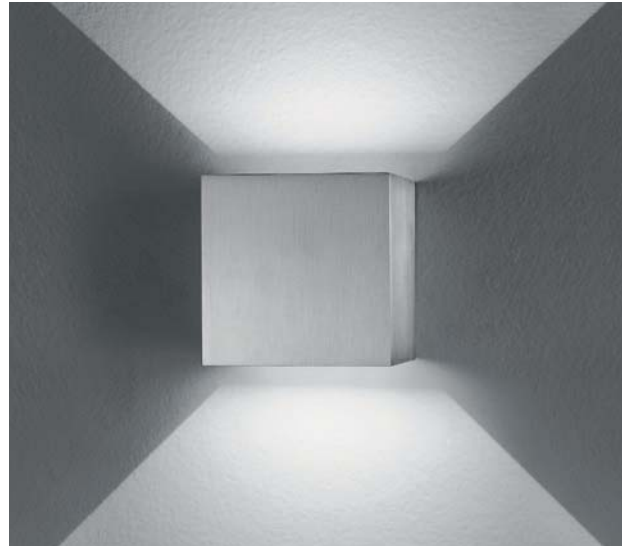
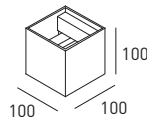

LED-wall luminaire 2x3 W, CRI>90, with built-in driver 230 V, housing made of extruded aluminium, leading edge/trailing edge dimmable, for direct and indirect lighting, to be used in indoor and outdoor areas, IP54



CODE	TYPE	COLOUR	LAMP	LUMEN*	POWER SUPPLY
D247	SECRET	white	2x3W LED □ 3000K	2x260 lm	incl. driver phase dim
D939	SECRET	black	2x3W LED □ 3000K	2x260 lm	incl. driver phase dim
D246	SECRET	grey	2x3W LED □ 3000K	2x260 lm	incl. driver phase dim
D239	SECRET	alu	2x3W LED □ 3000K	2x260 lm	incl. driver phase dim

SECRET UP

LED-Wandleuchte 1x3 W, CRI>90, mit eingebautem Driver 230 V, Gehäuse aus stranggepresstem Aluminium, für Direktbeleuchtung, für den Innen- und Außenbereich verwendbar, IP54

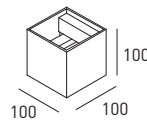

LED-wall luminaire 1x3 W, CRI>90, with built-in driver 230 V, housing made of extruded aluminium, for direct lighting, to be used in indoor and outdoor areas, IP54

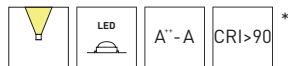

CODE	TYPE	COLOUR	LAMP	LUMEN*	POWER SUPPLY
D949	SECRET UP	white	1x3W LED □ 3000K	260 lm	incl. driver
D938	SECRET UP	black	1x3W LED □ 3000K	260 lm	incl. driver
D946	SECRET UP	grey	1x3W LED □ 3000K	260 lm	incl. driver

SECRET DOWN

LED-Wandleuchte 1x3 W, CRI>90, mit eingebautem Driver 230 V, Gehäuse aus stranggepresstem Aluminium, für Direktbeleuchtung, für den Innen- und Außenbereich verwendbar, IP54

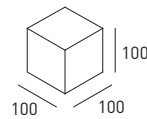

LED-wall luminaire 1x3 W, CRI>90, with built-in driver 230 V, housing made of extruded aluminium, for direct lighting, to be used in indoor and outdoor areas, IP54

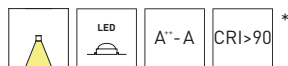

CODE	TYPE	COLOUR	LAMP	LUMEN*	POWER SUPPLY
D201	SECRET DOWN	white	1x3W LED □ 3000K	260 lm	incl. driver
D262	SECRET DOWN	black	1x3W LED □ 3000K	260 lm	incl. driver
D200	SECRET DOWN	grey	1x3W LED □ 3000K	260 lm	incl. driver



FLATBOX

LED-Wandleuchte 4 W, CRI>90, mit eingebautem Driver 230 V, Gehäuse aus massivem Aluminium, mit einseitigem Lichtaustritt, für den Innen- und Außenbereich verwendbar, IP54

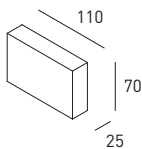

LED-wall luminaire 4 W, CRI>90, with built-in driver 230 V, housing made of aluminium, with one-sided light emission, to be used in indoor and outdoor areas, IP54

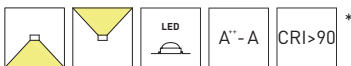

CODE	TYPE	COLOUR	LAMP	LUMEN*	POWER SUPPLY
D206	FLATBOX	white	4W LED □ 3000K	420 lm	incl. driver
D606	FLATBOX	black	4W LED □ 3000K	420 lm	incl. driver

SILENCE

LED-Wandleuchte 3 W mit eingebautem Driver 230 V, Gehäuse aus massivem Aluminium, mit einseitigem Lichtaustritt, für den Innen- und Außenbereich verwendbar, IP54

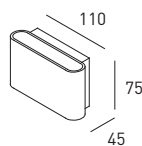

LED-wall luminaire 3 W with built-in driver 230 V, housing made of aluminium, with one-sided light emission, to be used in indoor and outdoor areas, IP54



CODE	TYPE	COLOUR	LAMP	LUMEN*	POWER SUPPLY
D220	SILENCE	white	3W LED □ 3000K	270 lm	incl. driver
D620	SILENCE	black	3W LED □ 3000K	270 lm	incl. driver
D221	SILENCE	grey	3W LED □ 3000K	270 lm	incl. driver



HARMONY

Wandleuchte 230 V mit Stoffschirm creme, für LED-Leuchtmittel geeignet

Wall luminaire 230 V with cream-coloured shade, LED lamps are suitable

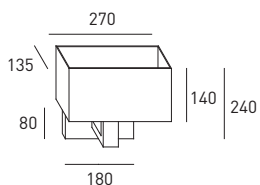

CODE	TYPE	COLOUR	LAMP	POWER SUPPLY
D625	HARMONY	chrome	1xE27 LED	230 V

HARMONY LED FLEX

Wandleuchte 230 V mit Stoffschirm creme, für LED-Leuchtmittel geeignet, mit LED-Leseleuchte 1 W und Flexarm 200 mm, Linsenoptik 40°, eingebautem Driver, zwei Schalter (getrennt schaltbar)

Wall luminaire 230 V with cream-coloured shade, LED lamps are suitable, with LED-fixture 1 W and flexible arm 200 mm, 40° lens, including driver, two switches (separately switchable)

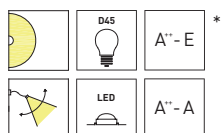
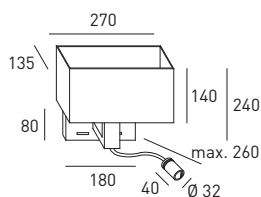

CODE	TYPE	COLOUR	LAMP	LUMEN*	POWER SUPPLY
D626	HARMONY LED FLEX	chrome	1xE27 LED + 1x1W LED 40° □ 3000K	- 95 lm	incl. driver / 230 V



CAPRI

LED-Wandstrahler 230 V, mit 4 W AC-LED, CRI>90, Wippschalter, hochwertigem Aluminiumreflektor mit Glasabdeckung, Gehäuse aus massivem Aluminium, dreh- und schwenkbar (350°/90°)

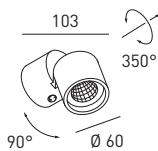

LED-wall luminaire 230 V, with 4 W AC-LED, CRI>90, rocker switch, high-quality aluminium reflector with glass cover, housing made of aluminium, adjustable (350°/90°)



CODE	TYPE	COLOUR	LAMP	LUMEN*	POWER SUPPLY
D950	CAPRI	white	1x4W LED 40° □ 2700K	305 lm	230 V
D951	CAPRI	black	1x4W LED 40° □ 2700K	305 lm	230 V



STANDING CAPRI

LED-Strahler 230 V, mit Standfuß, Kabel und 4 W AC-LED, CRI>90, Wippschalter, hochwertigem Aluminiumreflektor mit Glasabdeckung, Gehäuse aus massivem Aluminium, schwenkbar (90°)

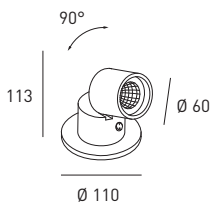

CODE	TYPE	COLOUR	LAMP	LUMEN*	POWER SUPPLY
D952	STANDING CAPRI	white	1x4W LED 40° □ 2700K	305 lm	230 V
D953	STANDING CAPRI	black	1x4W LED 40° □ 2700K	305 lm	230 V

LARA

LED-Leuchte 7 W, CRI>90, Aufbaugehäuse mit eingebautem Driver 230 V und Wippschalter, hochwertigem Aluminiumreflektor, Gehäuse aus massivem Aluminium, Leuchtenkopf dreh- und schwenkbar (350°/90°)

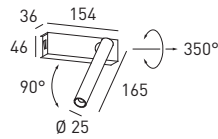

LED-fixture 7 W, CRI>90, surface mounted with built-in driver 230 V including rocker switch, high-quality aluminium reflector, housing made of aluminium, LED head adjustable (350°/90°)

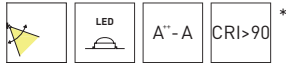

CODE	TYPE	COLOUR	LAMP	LUMEN*	POWER SUPPLY
D621	LARA	black	1x7W LED 15° □ 2700K	590 lm	incl. driver



* Technische Informationen siehe Seite 189 / Lumenangaben sind Nominalwerte - * Technical information see page 189 / Lumen data are nominal data

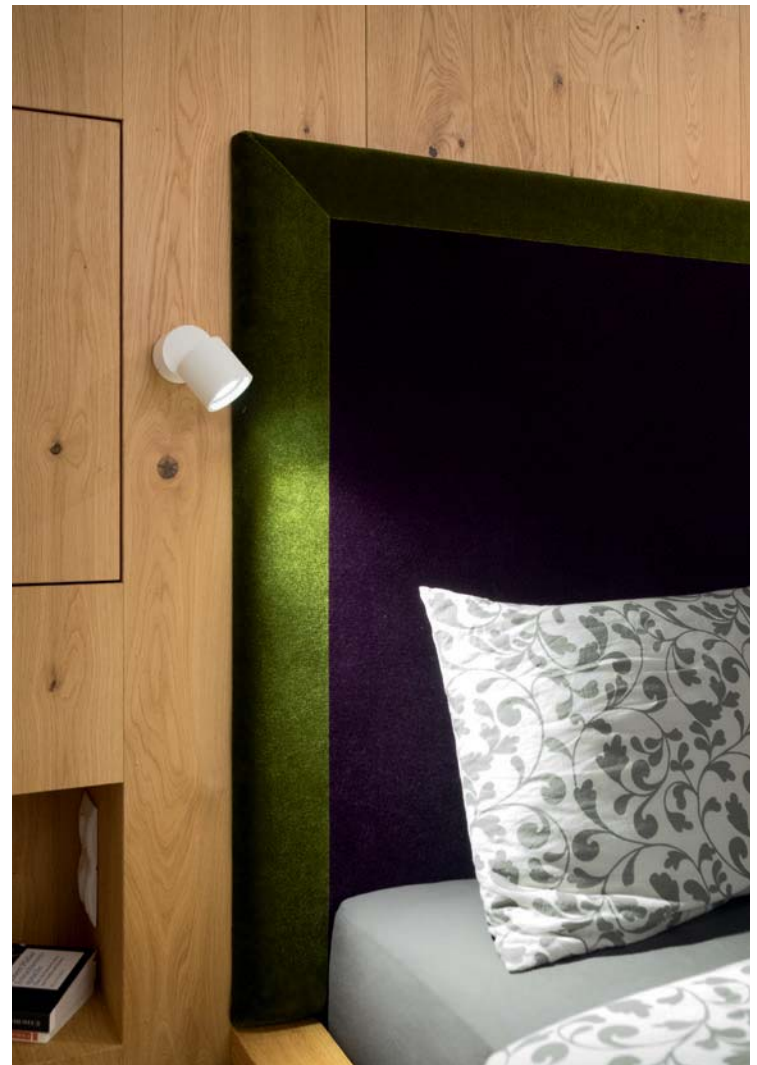

ZOOM T FLEX

LED-Leuchte 2 W, CRI>90, mit hochwertiger Glasoptik, Abstrahlwinkel fokussierbar von 15° bis 60°, Gehäuse aus massivem Aluminium, mit Flexarm 300 mm, Aufbaugehäuse mit eingebautem Driver 230 V und Druckschalter

LED-luminaire 2 W, CRI>90, with high-quality glass lens, focusable from 15° to 60°, housing made of aluminium, with flexible arm 300 mm, surface mounted with built-in driver 230 V and push-button switch

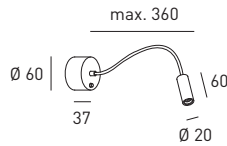
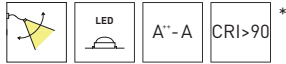

CODE	TYPE	COLOUR	LAMP	LUMEN*	POWER SUPPLY
136-09-00-05	ZOOM T FLEX	black	1x2W LED 15°-60° □ 3000K	190 lm	incl. driver
136-09-00-01	ZOOM T FLEX	chrome	1x2W LED 15°-60° □ 3000K	190 lm	incl. driver
136-09-00-33	ZOOM T FLEX	platinum	1x2W LED 15°-60° □ 3000K	190 lm	incl. driver

2700K LED auf Anfrage / 2700K LED on request

ZOOM TQ FLEX

LED-Leuchte 2 W, CRI>90, mit hochwertiger Glasoptik, Abstrahlwinkel fokussierbar von 15° bis 60°, Gehäuse aus massivem Aluminium, mit Flexarm 300 mm, Aufbaugehäuse mit eingebautem Driver 230 V und Druckschalter

LED-luminaire 2 W, CRI>90, with high-quality glass lens, focusable from 15° to 60°, housing made of aluminium, with flexible arm 300 mm, surface mounted with built-in driver 230 V and push-button switch

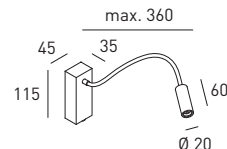
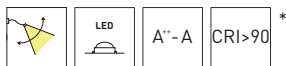

CODE	TYPE	COLOUR	LAMP	LUMEN*	POWER SUPPLY
137-09-00-05	ZOOM TQ FLEX	black	1x2W LED 15°-60° □ 3000K	190 lm	incl. driver
137-09-00-01	ZOOM TQ FLEX	chrome	1x2W LED 15°-60° □ 3000K	190 lm	incl. driver
137-09-00-33	ZOOM TQ FLEX	platinum	1x2W LED 15°-60° □ 3000K	190 lm	incl. driver

2700K LED auf Anfrage / 2700K LED on request

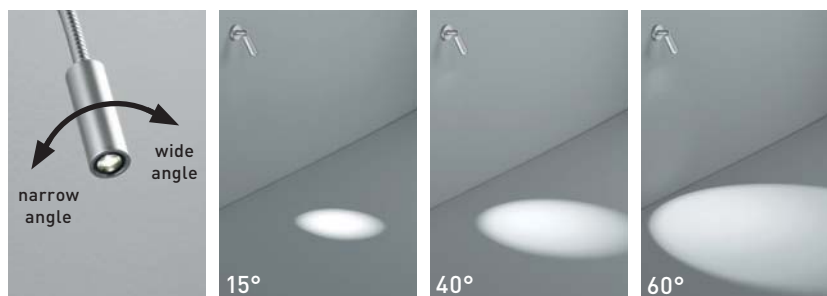

ZOOM-Leuchten sind von 15° bis 60° stufenlos fokussierbar

ZOOM luminaires are continuously focusable from 15° to 60°

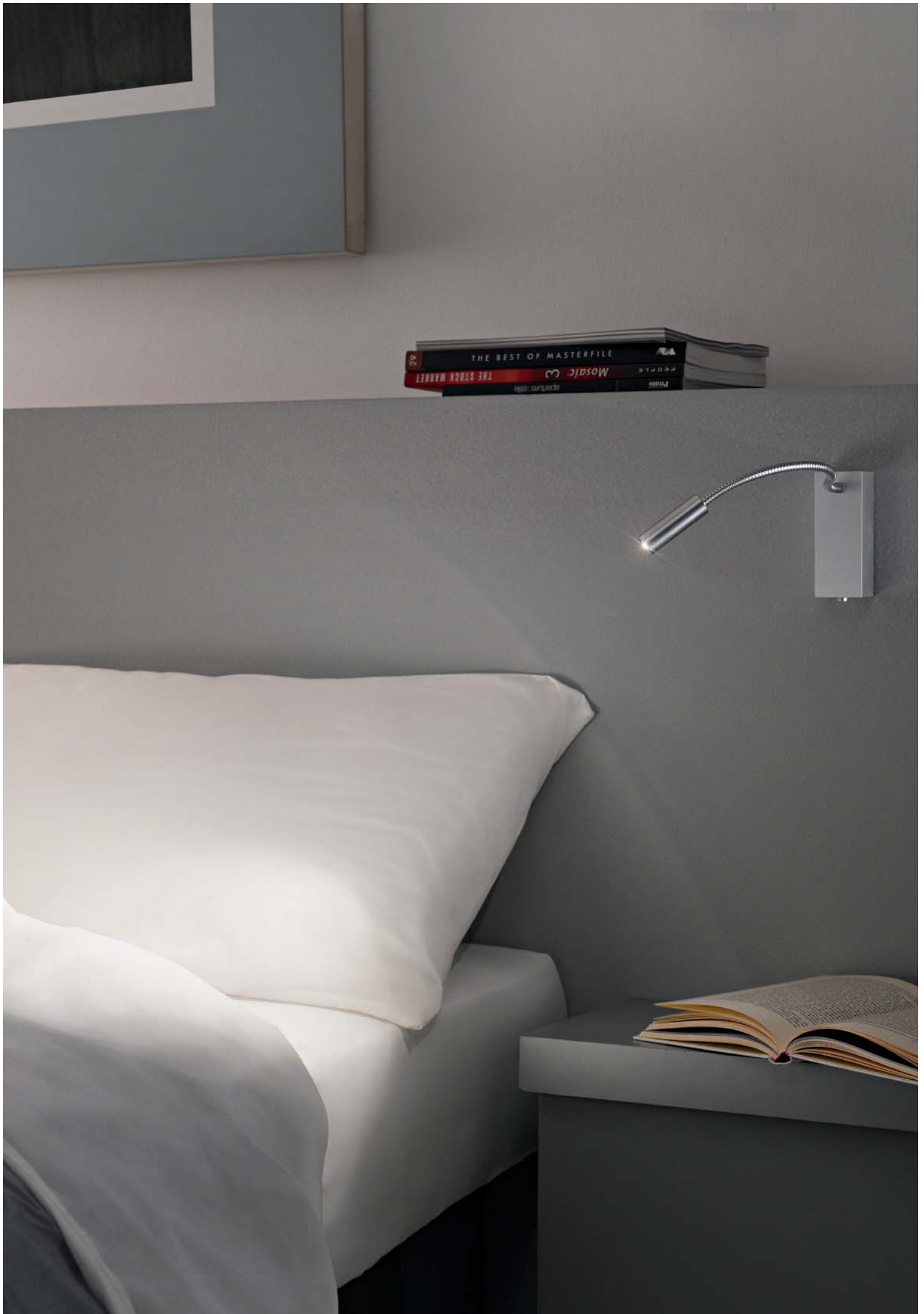

ZOOM AB FLEX LED-Leuchte 2 W, CRI>90, mit hochwertiger Glasoptik, Abstrahlwinkel fokussierbar von 15° bis 60°, Gehäuse aus massivem Aluminium, mit Flexarm 300 mm, Aufbauplatte, Driver bitte separat bestellen

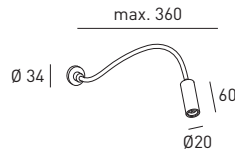

LED-luminaire 2 W, CRI>90, with high-quality glass lens, focusable from 15° to 60°, housing made of aluminium, with flexible arm 300 mm, surface mounted, please order driver separately

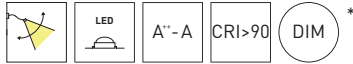

CODE	TYPE	COLOUR	LAMP	LUMEN*	POWER SUPPLY
139-09-00-05	ZOOM AB FLEX	black	1x2W LED 15°-60° □ 3000K	190 lm	excl. driver
139-09-00-01	ZOOM AB FLEX	chrome	1x2W LED 15°-60° □ 3000K	190 lm	excl. driver
139-09-00-33	ZOOM AB FLEX	platinum	1x2W LED 15°-60° □ 3000K	190 lm	excl. driver

2700K LED auf Anfrage / 2700K LED on request

ZOOM AB FLEX SWITCH

LED-Leuchte 2 W, CRI>90, mit hochwertiger Glasoptik, Abstrahlwinkel fokussierbar von 15° bis 60°, Gehäuse aus massivem Aluminium, mit Flexarm 300 mm, Einbauplatte und Druckschalter, Driver bitte separat bestellen

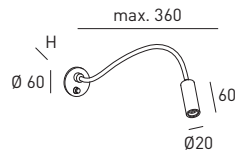

LED-luminaire 2 W, CRI>90, with high-quality glass lens, focusable from 15° to 60°, housing made of aluminium, with flexible arm 300 mm, surface mounted and push-button switch, please order driver separately

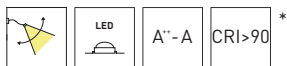

CODE	TYPE	COLOUR	LAMP	LUMEN*	POWER SUPPLY	H
140-09-00-05	ZOOM AB FLEX SWITCH	black	1x2W LED 15°-60° □ 3000K	190 lm	excl. driver	20 mm
140-09-00-01	ZOOM AB FLEX SWITCH	chrome	1x2W LED 15°-60° □ 3000K	190 lm	excl. driver	20 mm
140-09-00-33	ZOOM AB FLEX SWITCH	platinum	1x2W LED 15°-60° □ 3000K	190 lm	excl. driver	20 mm

2700K LED auf Anfrage / 2700K LED on request

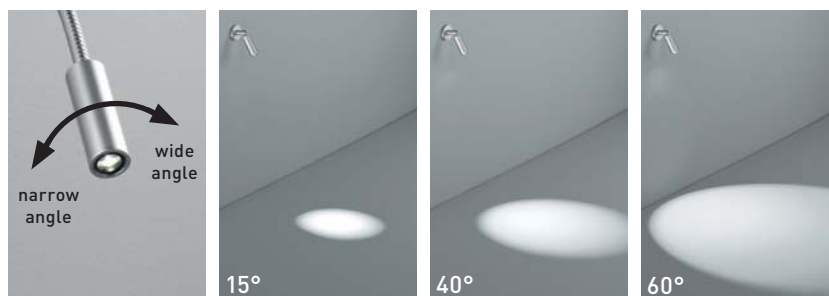

ZOOM-Leuchten sind von 15° bis 60° stufenlos fokussierbar

ZOOM luminaires are continuously focusable from 15° to 60°

Driver siehe Seite 195 ff. / Driver see page 195 ff.

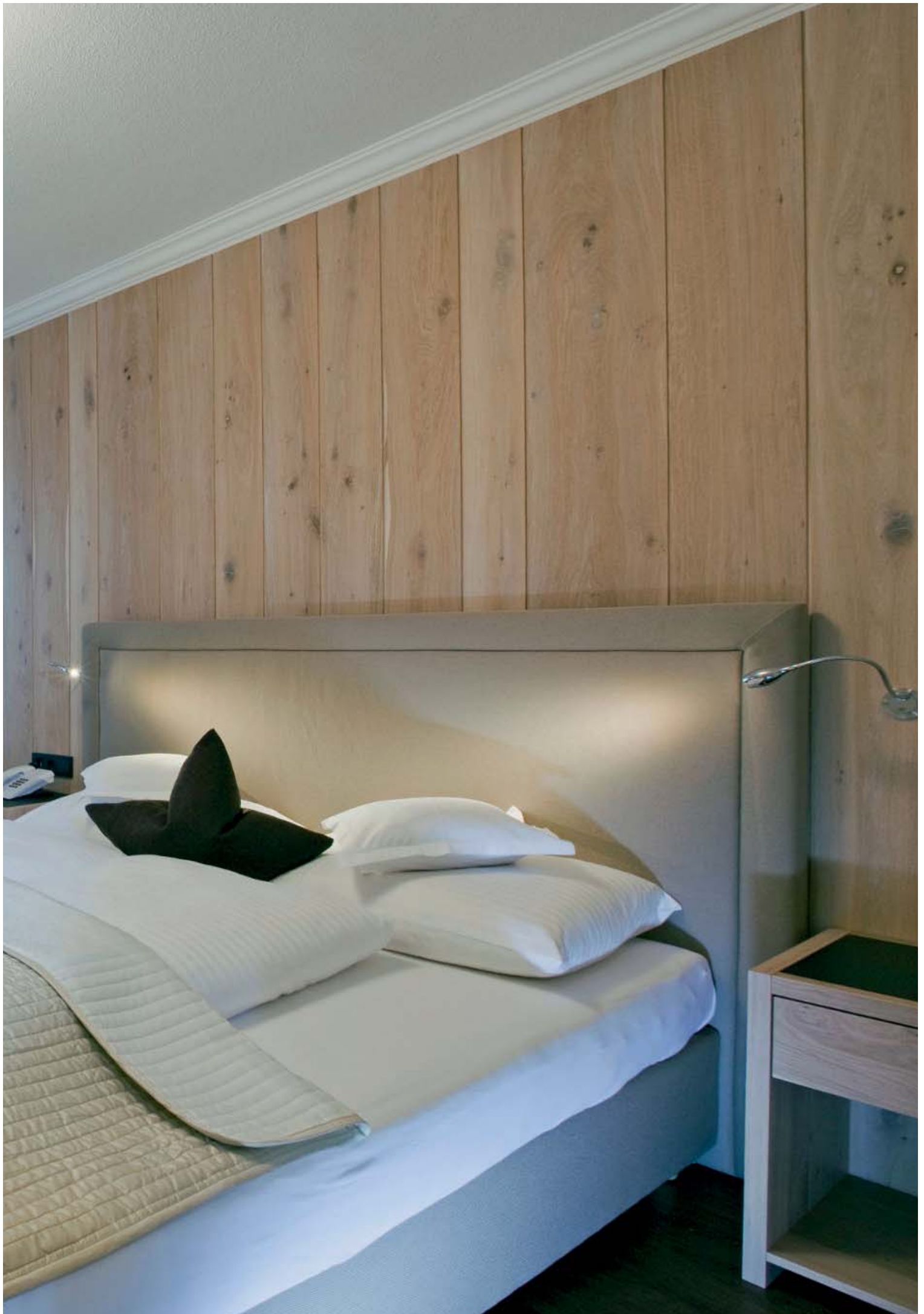

VEGA T FLEX

LED-Leuchte 2 W, CRI>90, Flexarm 300 mm mit Lederüberzug, Linsenoptik 60°, Gehäuse aus massivem Aluminium, Aufbaugeschäule mit eingebautem Driver 230 V und Druckschalter

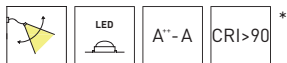
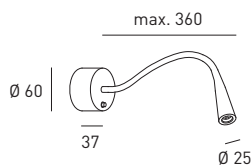

CODE	TYPE	COLOUR	LAMP	LUMEN*	POWER SUPPLY
760-09-29-61-05	VEGA T FLEX camel	black	1x2W LED 60° □ 3000K	190 lm	incl. driver
760-09-29-61-01	VEGA T FLEX camel	chrome	1x2W LED 60° □ 3000K	190 lm	incl. driver
760-09-29-61-33	VEGA T FLEX camel	platinum	1x2W LED 60° □ 3000K	190 lm	incl. driver
760-09-29-60-05	VEGA T FLEX espresso	black	1x2W LED 60° □ 3000K	190 lm	incl. driver
760-09-29-60-01	VEGA T FLEX espresso	chrome	1x2W LED 60° □ 3000K	190 lm	incl. driver
760-09-29-60-33	VEGA T FLEX espresso	platinum	1x2W LED 60° □ 3000K	190 lm	incl. driver

2700K LED und andere Befestigungsvarianten auf Anfrage / 2700K LED and other mounting versions on request

VEGA TQ FLEX

LED-Leuchte 2 W, CRI>90, Flexarm 300 mm mit Lederüberzug, Linsenoptik 60°, Gehäuse aus massivem Aluminium, Aufbaugeschäule mit eingebautem Driver 230 V und Druckschalter

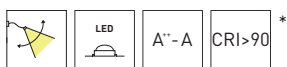
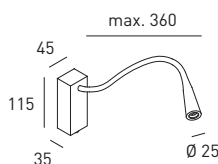

CODE	TYPE	COLOUR	LAMP	LUMEN*	POWER SUPPLY
761-09-29-61-05	VEGA TQ FLEX camel	black	1x2W LED 60° □ 3000K	190 lm	incl. driver
761-09-29-61-01	VEGA TQ FLEX camel	chrome	1x2W LED 60° □ 3000K	190 lm	incl. driver
761-09-29-61-33	VEGA TQ FLEX camel	platinum	1x2W LED 60° □ 3000K	190 lm	incl. driver
761-09-29-60-05	VEGA TQ FLEX espresso	black	1x2W LED 60° □ 3000K	190 lm	incl. driver
761-09-29-60-01	VEGA TQ FLEX espresso	chrome	1x2W LED 60° □ 3000K	190 lm	incl. driver
761-09-29-60-33	VEGA TQ FLEX espresso	platinum	1x2W LED 60° □ 3000K	190 lm	incl. driver

2700K LED und andere Befestigungsvarianten auf Anfrage / 2700K LED and other mounting versions on request

LEATHER COLOURS

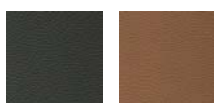

espresso

camel



RONA

LED-Leseleuchte 3 W, Aufbaugehäuse mit eingebautem Driver 230 V und Wippschalter, Gehäuse aus massivem Aluminium, Leuchtenkopf dreh- und schwenkbar (330°/90°), inkl. USB-Ladeanschluss und Smartphoneablage

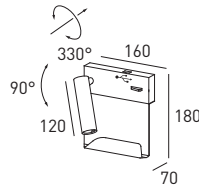

LED-fixture 3 W, surface mounted with built-in driver 230 V and rocker switch, housing made of aluminium, LED head adjustable (330°/90°), including USB charger and smartphone storage

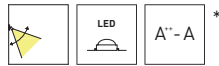

CODE	TYPE	COLOUR	LAMP	LUMEN*	POWER SUPPLY
D600	RONA	silvergrey	1x3W LED 40° □ 3000K	160 lm	incl. driver / USB: 5 V - 1 A

Lieferung ohne Smartphone und Kabel / delivery without smartphone and cable

FLOW T FLEX

LED-Leuchte 2 W, CRI>90, Gehäuse aus massivem Aluminium, mit Flexarm 300 mm, Linsenoptik 30°, Aufbaugehäuse mit eingebautem Driver 230 V und Druckschalter

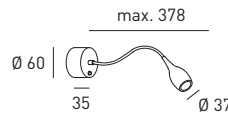

LED-luminaire 2 W, CRI>90, housing made of aluminium, with flexible arm 300 mm, 30° lens, surface mounted with built-in driver 230 V and push-button switch

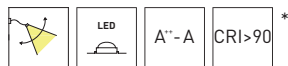

CODE	TYPE	COLOUR	LAMP	LUMEN*	POWER SUPPLY
852-09-15-05	FLOW T FLEX	black	1x2W LED 30° □ 3000K	190 lm	incl. driver
852-09-15-01	FLOW T FLEX	chrome	1x2W LED 30° □ 3000K	190 lm	incl. driver
852-09-15-33	FLOW T FLEX	platinum	1x2W LED 30° □ 3000K	190 lm	incl. driver

2700K LED und andere Befestigungsvarianten auf Anfrage / 2700K LED and other mounting versions on request

FLOW TQ FLEX

LED-Leuchte 2 W, CRI>90, Gehäuse aus massivem Aluminium, mit Flexarm 300 mm, Linsenoptik 30°, Aufbaugehäuse mit eingebautem Driver 230 V und Druckschalter

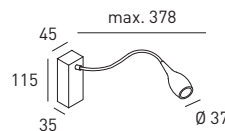

LED-luminaire 2 W, CRI>90, housing made of aluminium, with flexible arm 300 mm, 30° lens, surface mounted with built-in driver 230 V and push-button switch

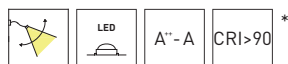

CODE	TYPE	COLOUR	LAMP	LUMEN*	POWER SUPPLY
833-09-15-05	FLOW TQ FLEX	black	1x2W LED 30° □ 3000K	190 lm	incl. driver
833-09-15-01	FLOW TQ FLEX	chrome	1x2W LED 30° □ 3000K	190 lm	incl. driver
833-09-15-33	FLOW TQ FLEX	platinum	1x2W LED 30° □ 3000K	190 lm	incl. driver

2700K LED und andere Befestigungsvarianten auf Anfrage / 2700K LED and other mounting versions on request

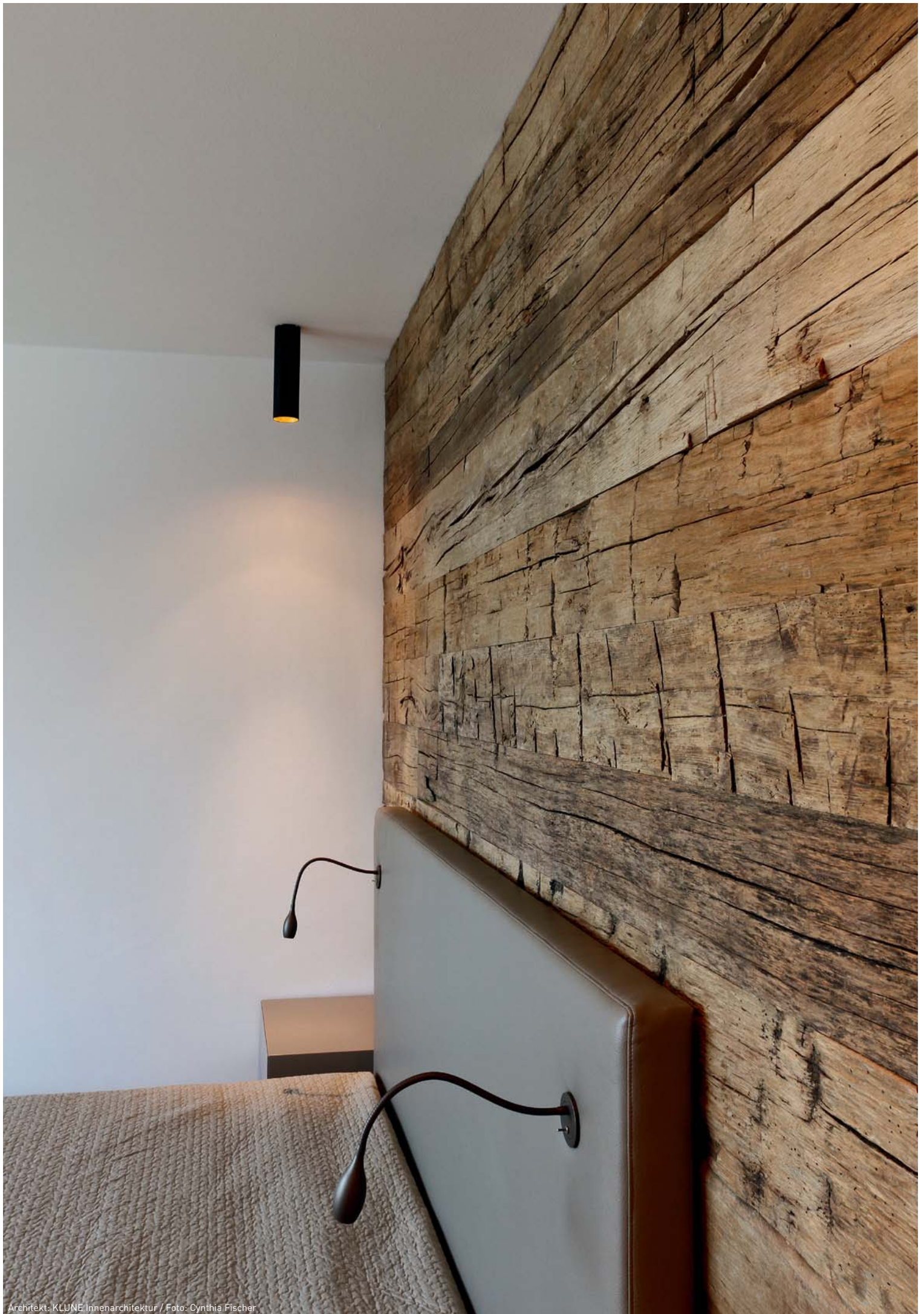

ZOOM TABLE

LED-Tischleuchte 2 W, CRI>90, mit Driver 230 V, Gehäuse aus massivem Aluminium, mit ovalem Standfuß, Flexarm 300 mm, hochwertiger Glasoptik, Abstrahlwinkel fokussierbar von 15° bis 60°, inklusive Schalter

LED-table luminaire 2 W, CRI>90, with driver 230 V, housing made of aluminium, with oval base, flexible arm 300 mm, high-quality glass lens, focusable from 15° to 60°, including switch

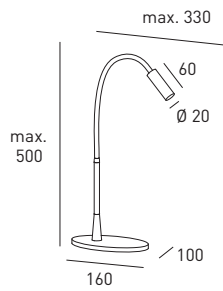
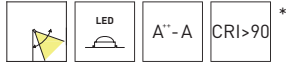

CODE	TYPE	COLOUR	LAMP	LUMEN*	POWER SUPPLY
135-09-00-05	ZOOM TABLE	black	1x2W LED 15°-60° □ 3000K	190 lm	incl. driver
135-09-00-33	ZOOM TABLE	platinum	1x2W LED 15°-60° □ 3000K	190 lm	incl. driver

ZOOM FLOOR

LED-Stehleuchte 2 W, CRI>90, mit Driver 230 V, Gehäuse aus massivem Aluminium, mit rundem Standfuß, Flexarm 300 mm, hochwertiger Glasoptik, Abstrahlwinkel fokussierbar von 15° bis 60°, inklusive Schalter

LED-floor luminaire 2 W, CRI>90, with driver 230 V, housing made of aluminium, with round base, flexible arm 300 mm, high-quality glass lens, focusable from 15° to 60°, including switch

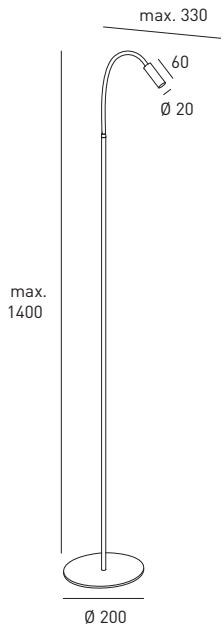
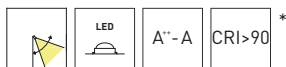

CODE	TYPE	COLOUR	LAMP	LUMEN*	POWER SUPPLY
141-09-00-05	ZOOM FLOOR	black	1x2W LED 15°-60° □ 3000K	190 lm	incl. driver
141-09-00-33	ZOOM FLOOR	platinum	1x2W LED 15°-60° □ 3000K	190 lm	incl. driver

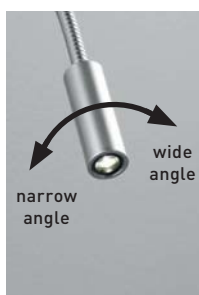

ZOOM-Leuchten sind von 15° bis 60° stufenlos fokussierbar

ZOOM luminaires are continuously focusable from 15° to 60°



SOHO

Tischleuchte 230V, E27, Gehäuse aus massivem Aluminium, inklusive Schalter, für LED-Leuchtmittel geeignet

Table luminaire 230 V, E27, housing made of aluminium, including switch, LED lamps are suitable

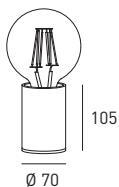

Symbolfoto / symbolic photo

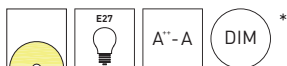

CODE	TYPE	COLOUR	LAMP	POWER SUPPLY
D538	SOHO	black	1xE27 LED	230 V
D539	SOHO	brass	1xE27 LED	230 V

Lieferung ohne Leuchtmittel / delivery without lamp



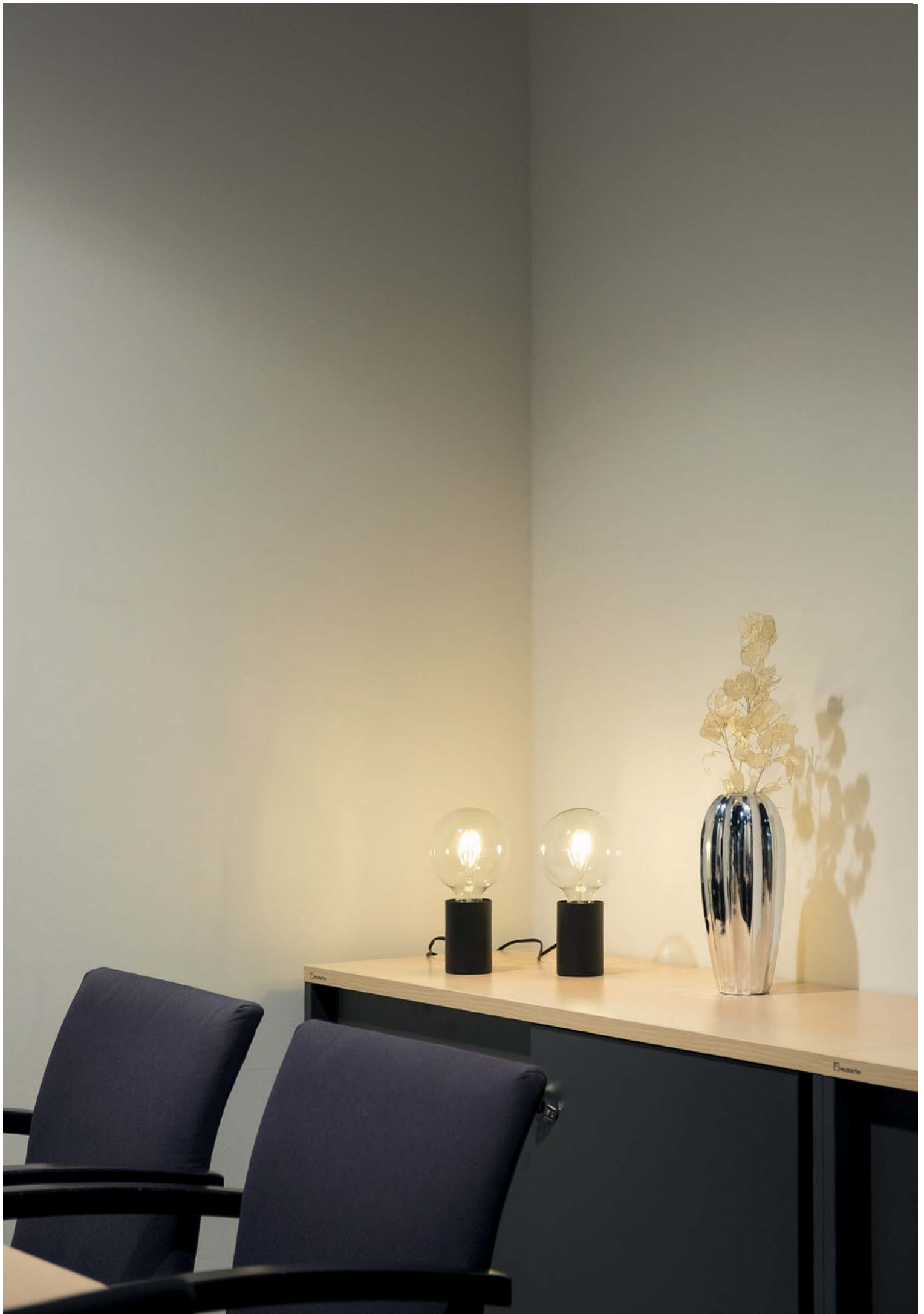

SPLIT

LED-Wandeinbauleuchte 2 W, CRI>90, Gehäuse aus massivem Aluminium, außen weiß, innen mattgold oder weiß, inklusive Driver und Einbaugehäuse

LED-wall recessed luminaire 2 W, CRI>90, housing made of aluminium, outside white, inside dull gold or white, including driver and mounting box

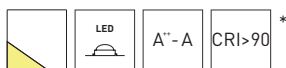
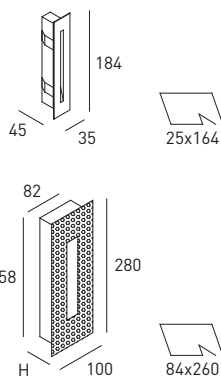

CODE	TYPE	COLOUR	LAMP	LUMEN*	POWER SUPPLY	H
D297	SPLIT	white/white	1x2W LED □ 3000K	185 lm	incl. driver	55 mm
D298	SPLIT	white/gold	1x2W LED □ 3000K	185 lm	incl. driver	55 mm

H = Einbautiefe / recessed depth

LUCKY STAR

LED-Wandeinbauleuchte 230 V mit 4 W AC-LED, CRI>90, dimmbar mit Phasenanschnittdimmer, Gehäuse aus massivem Aluminium

LED-wall recessed luminaire 230 V with 4 W AC-LED, CRI>90, leading edge dimmable, housing made of aluminium

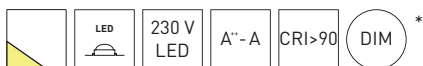
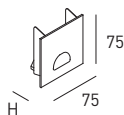

CODE	TYPE	COLOUR	LAMP	LUMEN*	POWER SUPPLY	H
D789	LUCKY STAR	white	1x4W LED □ 3000K	360 lm	230 V phase dim	50 mm

Unterputzdose auf Anfrage / mounting box on request

H = Einbautiefe / recessed depth

SAXO

LED-Wandeinbauleuchte 2 W, Gehäuse aus massivem Aluminium, inklusive Driver und Einbaugehäuse, für den Innen- und Außenbereich verwendbar, IP54

LED-wall recessed luminaire 2 W, housing made of aluminium, including driver and mounting box, to be used in indoor and outdoor areas, IP54

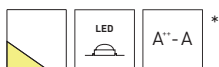
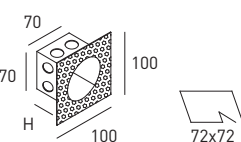
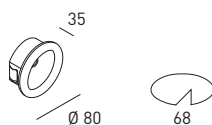

CODE	TYPE	COLOUR	LAMP	LUMEN*	POWER SUPPLY	H
D202	SAXO	white	1x2W LED □ 3000K	170 lm	incl. driver	50 mm
D702	SAXO	grey	1x2W LED □ 3000K	170 lm	incl. driver	50 mm

H = Einbautiefe / recessed depth

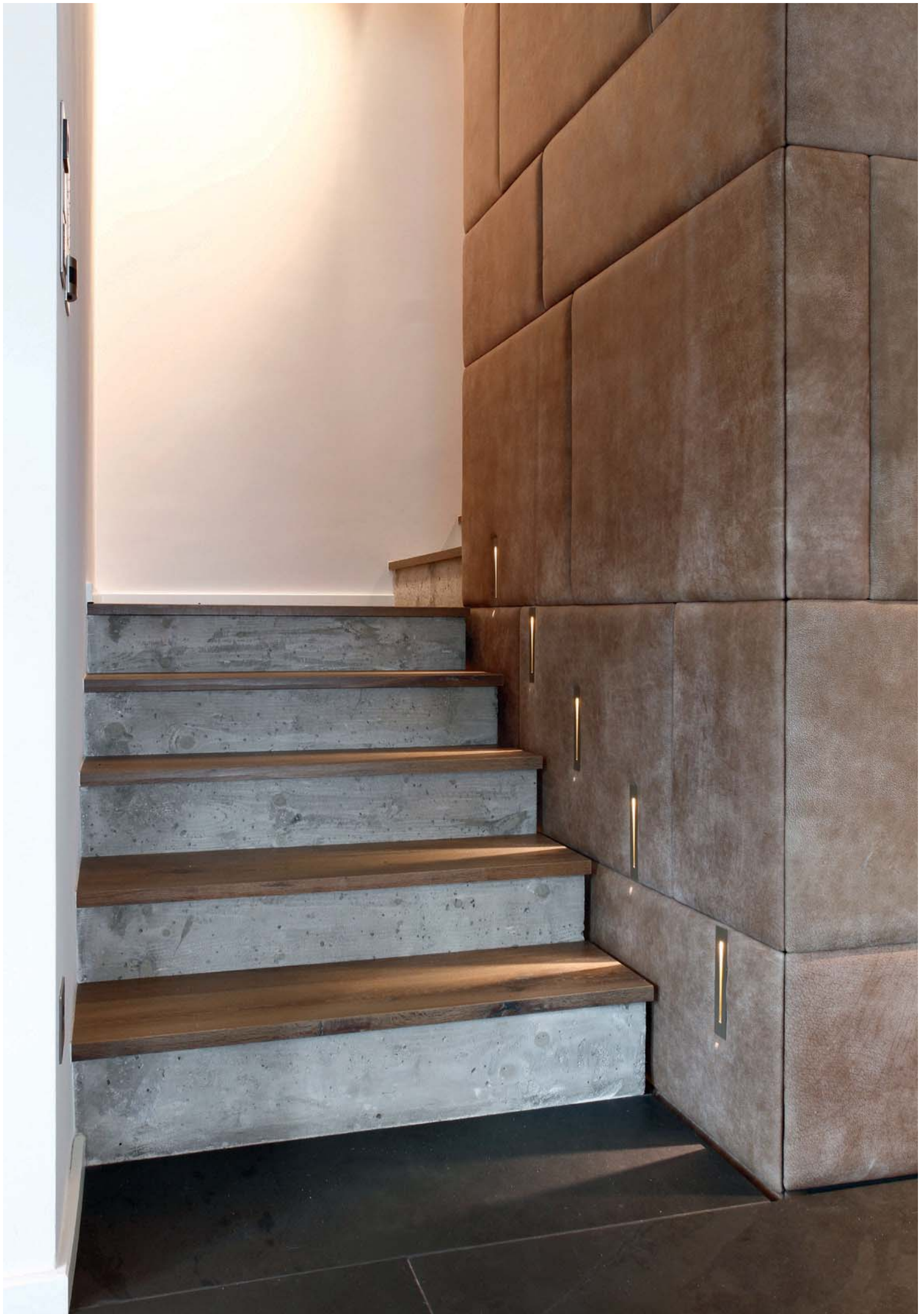

SAXO ON

LED-Wandleuchte 2 W,
Gehäuse aus massivem
Aluminium, inklusive Driver,
für den Innen- und Außen-
bereich verwendbar, IP54

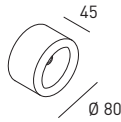

LED-wall luminaire 2 W,
housing made of aluminium,
including driver, to be used
in indoor and outdoor areas,
IP54

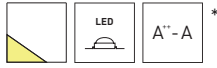

CODE	TYPE	COLOUR	LAMP	LUMEN*	POWER SUPPLY
D203	SAXO ON	white	1x2W LED □ 3000K	170 lm	incl. driver

PIXEL

LED-Wandeinbauleuchte
1 W, CRI>90, Gehäuse aus
massivem Aluminium, Driver
bitte separat bestellen, für
den Innen- und Außenbe-
reich verwendbar, IP44

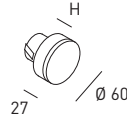

LED-wall recessed luminaire
1 W, CRI>90, housing made
of aluminium, please order
driver separately, to be used
in indoor and outdoor areas,
IP44

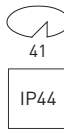
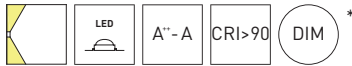

CODE	TYPE	COLOUR	LAMP	LUMEN*	POWER SUPPLY	H
D229	PIXEL	white	1x1W LED □ 3000K 350mA	92 lm	excl. driver	45 mm
D279	PIXEL	alu	1x1W LED □ 3000K 350mA	92 lm	excl. driver	45 mm

H = Einbautiefe / recessed depth



ACCESSORIES



Unterputzdose für PIXEL Q
Mounting box for PIXEL

CODE	TYPE	COLOUR
9000-0141	MOUNTING BOX 41	-

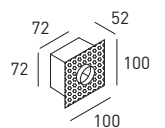

Betoneinbauhülsen für PIXEL
Concrete mounting sleeve for PIXEL

CODE	TYPE	COLOUR
9000-0241	MOUNTING SLEEVE 41	-

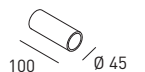

Driver siehe Seite 195 ff. / Driver see page 195 ff.



SMILE

LED-Wandeinbauleuchte 2 W, CRI>90, Gehäuse aus Aluminium, optional in exotierter IP65-Version für den Außenbereich, Driver bitte separat bestellen

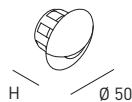

LED-wall recessed luminaire 2 W, CRI>90, housing made of aluminium, optional in anodized IP65 version to be used in outdoor areas, please order driver separately

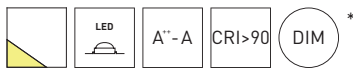

CODE	TYPE	COLOUR	LAMP	LUMEN*	POWER SUPPLY	H
492-09-00-03	SMILE	white	1x2W LED □ 3000K 500mA	190 lm	excl. driver	25 mm
492-09-00-05	SMILE	black	1x2W LED □ 3000K 500mA	190 lm	excl. driver	25 mm
492-09-00-01	SMILE	chrome	1x2W LED □ 3000K 500mA	190 lm	excl. driver	25 mm
492-09-00-33	SMILE	platinum	1x2W LED □ 3000K 500mA	190 lm	excl. driver	25 mm
IP65 494-09-00-41	SMILE IP65	black anodized	1x2W LED □ 3000K 500mA	190 lm	excl. driver	34 mm
494-09-00-40	SMILE IP65	nature anodized	1x2W LED □ 3000K 500mA	190 lm	excl. driver	34 mm

H = Einbautiefe / recessed depth

SMILE Q

LED-Wandeinbauleuchte 2 W, CRI>90, Gehäuse aus Aluminium, Driver bitte separat bestellen

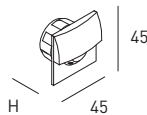

LED-wall recessed luminaire 2 W, CRI>90, housing made of aluminium, please order driver separately

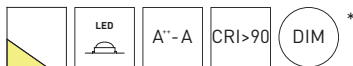

CODE	TYPE	COLOUR	LAMP	LUMEN*	POWER SUPPLY	H
892-09-00-03	SMILE Q	white	1x2W LED □ 3000K 500mA	190 lm	excl. driver	25 mm
892-09-00-05	SMILE Q	black	1x2W LED □ 3000K 500mA	190 lm	excl. driver	25 mm
892-09-00-33	SMILE Q	platinum	1x2W LED □ 3000K 500mA	190 lm	excl. driver	25 mm

H = Einbautiefe / recessed depth

ACCESSORIES



Unterputzdose für SMILE und SMILE Q
Mounting box for SMILE and SMILE Q

CODE	TYPE	COLOUR
9000-0136	MOUNTING BOX 36	-

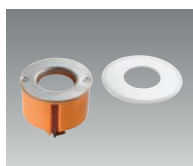
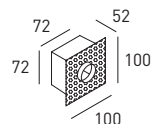

Montagering (2-teilig) für Hohlwanddosen Ø 68 mm für SMILE und SMILE Q
Mounting ring (2-parts) for junction boxes Ø 68 mm for SMILE and SMILE Q

CODE	TYPE	COLOUR
9000-0336	MOUNTING RING 36	white

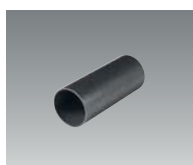

Betoneinbauhülsen für SMILE und SMILE Q
Concrete mounting sleeve for SMILE and SMILE Q

CODE	TYPE	COLOUR
9000-0236	MOUNTING SLEEVE 36	-



Driver siehe Seite 195 ff. / Driver see page 195 ff.



Lichtplanung: LichtJa Hamburg



PHANTOM

Wand- und Deckenhalb-
einbauleuchte, Gehäuse
aus massivem Aluminium,
erhältlich für 2 W LED und
12 V Halogen, Driver oder
Transformator bitte separat
bestellen

Wall and ceiling recessed
luminaire, housing made of
aluminum, available for 2 W
LED and 12 V halogen, please
order driver or transformer
separately

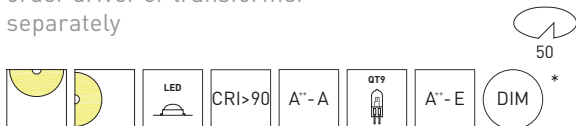
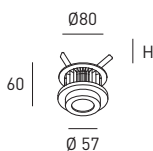

CODE	TYPE	COLOUR	LAMP	LUMEN*	POWER SUPPLY	H
D420-09	PHANTOM	alu	1x2W LED 3000K 500mA	190 lm	excl. driver	50 mm
D420-04	PHANTOM	alu	1x2W LED blue 500mA	-	excl. driver	50 mm
D420-07	PHANTOM	alu	1x2W LED red 500mA	-	excl. driver	50 mm
D420-15	PHANTOM	alu	1x2W LED green 500mA	-	excl. driver	50 mm
D420-16	PHANTOM	alu	1x2W LED amber 500mA	-	excl. driver	50 mm
D420	PHANTOM	alu	1x20W/G4	-	excl. transformer	50 mm

H = Einbautiefe / recessed depth

TAIFUN

Wand- und Deckenhalb-
einbauleuchte, Gehäuse
aus massivem Aluminium,
erhältlich für 2 W LED und
12 V Halogen, Driver oder
Transformator bitte separat
bestellen

Wall and ceiling recessed
luminaire, housing made of
aluminum, available for 2 W
LED and 12 V halogen, please
order driver or transformer
separately

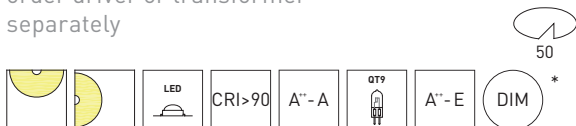
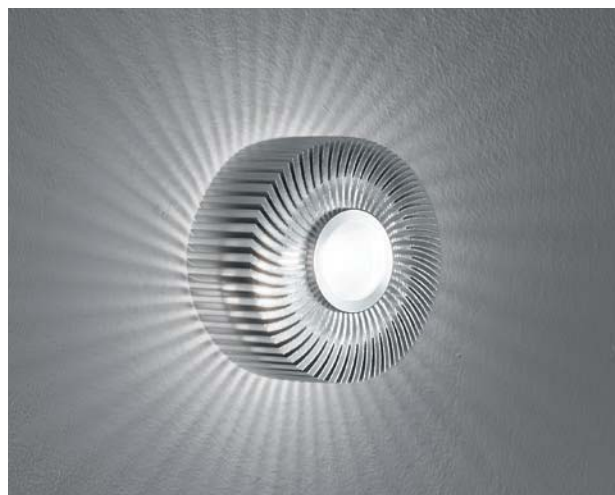
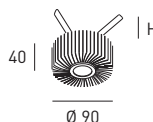

CODE	TYPE	COLOUR	LAMP	LUMEN*	POWER SUPPLY	H
D421-09	TAIFUN	alu	1x2W LED 3000K 500mA	190 lm	excl. driver	50 mm
D421-04	TAIFUN	alu	1x2W LED blue 500mA	-	excl. driver	50 mm
D421-07	TAIFUN	alu	1x2W LED red 500mA	-	excl. driver	50 mm
D421-15	TAIFUN	alu	1x2W LED green 500mA	-	excl. driver	50 mm
D421-16	TAIFUN	alu	1x2W LED amber 500mA	-	excl. driver	50 mm
D421	TAIFUN	alu	1x20W/G4	-	excl. transformer	50 mm

H = Einbautiefe / recessed depth

Driver & Transformatoren siehe Seite 194 ff. / Driver & Transformer see page 194 ff.



KELLY

LED-Strahler 15 W, CRI>90, mit hochwertiger Glasoptik, Abstrahlwinkel fokussierbar von 15° bis 90°, dreh- und schwenkbar (350°/90°), Gehäuse aus Aluminium, mit eingebautem Driver, dimmbar mit Phasenabschrittdimmer, mit 3-Phasen-Universaladapter

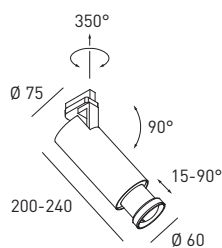

LED-spotlight 15 W, CRI>90, with high-quality glass lens, focusable from 15° to 90°, adjustable (350°/90°), housing made of aluminium, with built-in driver, trailing edge dimmable, with 3-phase universal adapter

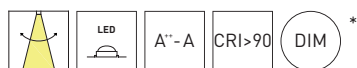

CODE	TYPE	COLOUR	LAMP	LUMEN*	POWER SUPPLY
D594	KELLY	white	1x15W LED 15°-90° □ 2700K	1450 lm	incl. driver phase dim
D593	KELLY	black	1x15W LED 15°-90° □ 2700K	1450 lm	incl. driver phase dim
D598	KELLY	white	1x15W LED 15°-90° □ 3000K	1490 lm	incl. driver phase dim
D597	KELLY	black	1x15W LED 15°-90° □ 3000K	1490 lm	incl. driver phase dim

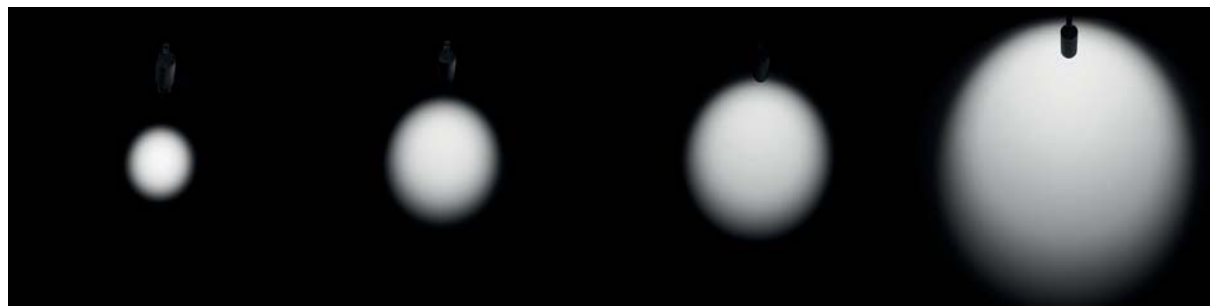

Abstrahlwinkel fokussierbar von 15° bis 90° / Beam angle focusable from 15° to 90°



3-Phasen Stromschienen und -zubehör siehe S. 192 ff.
3-phase lighting tracks and accessories see page 192 ff.

REED XL

LED-Strahler 33 W, CRI>90, mit tiefer gesetzter LED und hochwertiger Linsenoptik, dreh- und schwenkbar (350°/90°), Gehäuse aus Aluminium, mit eingebautem Driver, mit 3-Phasen-Universaladapter

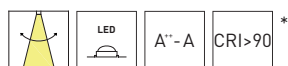
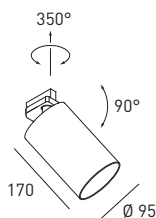

CODE	TYPE	COLOUR	LAMP	LUMEN*	POWER SUPPLY
D629-15	REED XL	white	1x33W LED 15° □ 3000K	3470 lm	incl. driver
D629-32	REED XL	white	1x33W LED 32° □ 3000K	3470 lm	incl. driver
D629-50	REED XL	white	1x33W LED 50° □ 3000K	3470 lm	incl. driver
D628-15	REED XL	black	1x33W LED 15° □ 3000K	3470 lm	incl. driver
D628-32	REED XL	black	1x33W LED 32° □ 3000K	3470 lm	incl. driver
D628-50	REED XL	black	1x33W LED 50° □ 3000K	3470 lm	incl. driver



KENT

LED-Strahler 30 W, CRI>90, mit hocheffizientem Aluminiumreflektor, Gehäuse aus Aluminiumdruckguss, mit eingebautem Driver, dimmbar mit Phasenabschrittdimmer, mit 3-Phasen-Universaladapter

LED-spotlight 30 W, CRI>90, with high output aluminium reflector, housing made of die-cast aluminium, with built-in driver, trailing edge dimmable, with 3-phase universal adapter

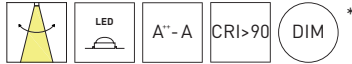
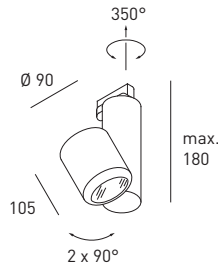

CODE	TYPE	COLOUR	LAMP	LUMEN*	POWER SUPPLY
D732-__	KENT	white	1x30W LED □ 3000K	3200 lm	incl. driver phase dim
D734-__	KENT	black	1x30W LED □ 3000K	3200 lm	incl. driver phase dim
D742-__	KENT	white	1x30W LED □ 4000K	3440 lm	incl. driver phase dim
D745-__	KENT	black	1x30W LED □ 4000K	3440 lm	incl. driver phase dim

DALI-Ausführung auf Anfrage / DALI version on request

BEAM ANGLE

Bitte wählen Sie den Abstrahlwinkel aus: / Please choose the beam angle:



CODE	BEAM ANGLE
Dxxx-15	15°
Dxxx-26	26° (standard)
Dxxx-38	38°

3-Phasen Stromschienen und -zubehör siehe S. 192 ff.
3-phase lighting tracks and accessories see page 192 ff.

ACCESSORIES



Blendschutzklappen für KENT
Antiglare shade for KENT

CODE	TYPE	max. LxWxH (60°)	COLOUR
D140	ANTI GLARE SHADE	200x200x80 mm	black



Snoot für KENT
Snoot for KENT

CODE	TYPE	LxØ	COLOUR
D141	SNOOT	-	black



Wabenraster für KENT
Honey comb louver for KENT

CODE	TYPE	LxØ	COLOUR
D142	HONEY COMB LOUVER	-	black

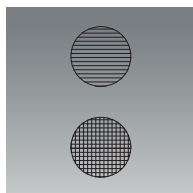

Filter für KENT
Filter for KENT

CODE	TYPE	LxØ	COLOUR
D165	LINEAR DIFFUSION	-	-
D166	PRISMATIC DIFFUSION	-	-



filtereffect linear diffusion: 15°, 26°, 38°



filtereffect prismatic diffusion: 15°, 26°, 38°



KENT S

LED-Strahler 15 W, CRI>90, mit hocheffizientem Aluminiumreflektor, Gehäuse aus Aluminiumdruckguss, mit eingebautem Driver, dimmbar mit Phasenanschnitt-/Phasenabschrittdimmer, mit 3-Phasen-Universaladapter

LED-spotlight 15 W, CRI>90, with high output aluminium reflector, housing made of die-cast aluminium, with built-in driver, leading edge/trailing edge dimmable, with 3-phase universal adapter

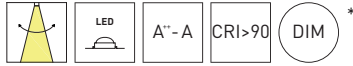
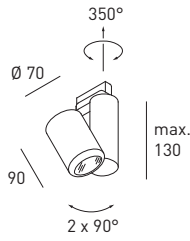

CODE	TYPE	COLOUR	LAMP	LUMEN*	POWER SUPPLY
D978-__	KENT S	white	1x15W LED □ 2700K	1410 lm	incl. driver phase dim
D982-__	KENT S	black	1x15W LED □ 2700K	1410 lm	incl. driver phase dim
D962-__	KENT S	white	1x15W LED □ 3000K	1465 lm	incl. driver phase dim
D966-__	KENT S	black	1x15W LED □ 3000K	1465 lm	incl. driver phase dim
D970-__	KENT S	white	1x15W LED □ 4000K	1565 lm	incl. driver phase dim
D974-__	KENT S	black	1x15W LED □ 4000K	1565 lm	incl. driver phase dim

BEAM ANGLE

Bitte wählen Sie den Abstrahlwinkel aus: / Please choose the beam angle:



CODE	BEAM ANGLE
Dxxx-10	10°
Dxxx-18	18°
Dxxx-30	30° (standard)
Dxxx-38	38°

ACCESSORIES



Snoot für KENT S und KENT S P1
Snoot for KENT S and KENT S P1

CODE	TYPE	LxØ	COLOUR
D144	SNOOT	-	black

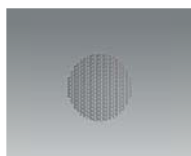

Wabenraster für KENT S und KENT S P1
Honey comb louver for KENT S and KENT S P1

CODE	TYPE	LxØ	COLOUR
D145	HONEY COMB LOUVER	-	black

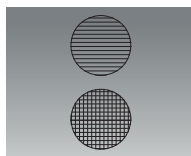

Filter für KENT S und KENT S P1
Filter for KENT S and KENT S P1

CODE	TYPE	LxØ	COLOUR
D167	LINEAR DIFFUSION	-	-
D168	PRISMATIC DIFFUSION	-	-



filtereffect linear diffusion: 15°, 26°, 38°



filtereffect prismatic diffusion: 15°, 26°, 38°

3-Phasen Stromschienen und -zubehör siehe S. 192 ff.
3-phase lighting tracks and accessories see page 192 ff.

KENT S P1

LED-Strahler 15 W, CRI>90, mit hocheffizientem Aluminiumreflektor, Gehäuse aus Aluminiumdruckguss, mit eingebautem Driver, dimmbar mit Phasenanschnitt-/Phasenabschnittdimmer, mit Global 1-Phasenadapter

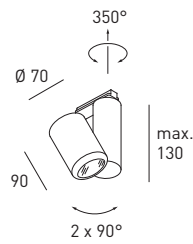

CODE	TYPE	COLOUR	LAMP	LUMEN*	POWER SUPPLY
D954-__	KENT S P1	white	1x15W LED □ 2700K	1410 lm	incl. driver phase dim
D955-__	KENT S P1	black	1x15W LED □ 2700K	1410 lm	incl. driver phase dim
D989-__	KENT S P1	white	1x15W LED □ 3000K	1465 lm	incl. driver phase dim
D990-__	KENT S P1	black	1x15W LED □ 3000K	1465 lm	incl. driver phase dim
D991-__	KENT S P1	white	1x15W LED □ 4000K	1565 lm	incl. driver phase dim
D992-__	KENT S P1	black	1x15W LED □ 4000K	1565 lm	incl. driver phase dim

1-Phasen Stromschienen und -zubehör siehe S. 190 f.
1-phase lighting tracks and accessories see page 190 f.

* Technische Informationen siehe Seite 189 / Lumenangaben sind Nominalwerte - * Technical information see page 189 / Lumen data are nominal data







Foto: Martin Steintaler



KENT BAKERY

LED-Strahler 32 W mit spezieller Lichtfarbe für Bäckereiwaren, hocheffizientem Aluminiumreflektor, Gehäuse aus Aluminiumdruckguss, mit eingebautem Driver und 3-Phasen-Universaladapter

LED-spotlight 32 W with special light colour for bakery products, high output aluminium reflector, housing made of die-cast aluminium, with built-in driver and 3-phase universal adapter

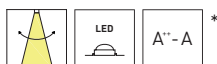
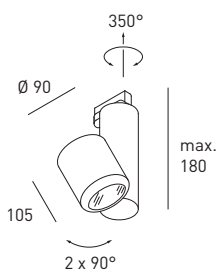

CODE	TYPE	COLOUR	LAMP	LUMEN*	POWER SUPPLY
D736-15	KENT BAKERY	white	1x32W LED 15° □ 2500K	2200 lm	incl. driver
D736-26	KENT BAKERY	white	1x32W LED 26° □ 2500K	2200 lm	incl. driver
D736-38	KENT BAKERY	white	1x32W LED 38° □ 2500K	2200 lm	incl. driver
D739-15	KENT BAKERY	black	1x32W LED 15° □ 2500K	2200 lm	incl. driver
D739-26	KENT BAKERY	black	1x32W LED 26° □ 2500K	2200 lm	incl. driver
D739-38	KENT BAKERY	black	1x32W LED 38° □ 2500K	2200 lm	incl. driver

Zubehör siehe Seite 92 / accessories see page 92



KENT MEAT

LED-Strahler 32 W mit spezieller Lichtfarbe für Fleischwaren, hocheffizientem Aluminiumreflektor, Gehäuse aus Aluminiumdruckguss, mit eingebautem Driver und 3-Phasen-Universaladapter

LED-spotlight 32 W with special light colour for meat products, high output aluminium reflector, housing made of die-cast aluminium, with built-in driver and 3-phase universal adapter

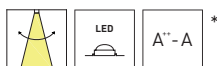
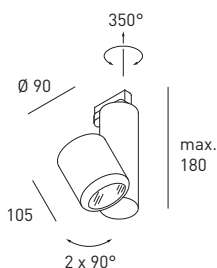

CODE	TYPE	COLOUR	LAMP	LUMEN*	POWER SUPPLY
D766-15	KENT MEAT	white	1x32W LED 15° □ 1750K	2000 lm	incl. driver
D766-26	KENT MEAT	white	1x32W LED 26° □ 1750K	2000 lm	incl. driver
D766-38	KENT MEAT	white	1x32W LED 38° □ 1750K	2000 lm	incl. driver
D769-15	KENT MEAT	black	1x32W LED 15° □ 1750K	2000 lm	incl. driver
D769-26	KENT MEAT	black	1x32W LED 26° □ 1750K	2000 lm	incl. driver
D769-38	KENT MEAT	black	1x32W LED 38° □ 1750K	2000 lm	incl. driver

Zubehör siehe Seite 92 / accessories see page 92



3-Phasen Stromschienen und -zubehör siehe S. 192 ff. / 3-phase lighting tracks and accessories see page 192 ff.



Architekt: KLUNE Innenarchitektur / Foto: Cynthia Fischer



Planung: Ahrens Planung & Beratung / Foto: Frank Ahrens

REED

Strahler 230 V mit tiefer gesetztem Leuchtmittel, dreh- und schwenkbar (350°/90°), Gehäuse aus Aluminiumdruckguss, für LED- und Halogen-Leuchtmittel geeignet, Entblendungsring wahlweise gold oder schwarz, mit 3-Phasen-Universaladapter

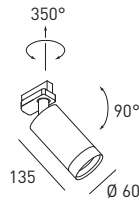

Spotlight 230 V with recessed illuminant, adjustable (350°/90°), housing made of die-cast aluminium, LED and halogen lamps are suitable, anti glare ring optionally gold or black, with 3-phase universal adapter

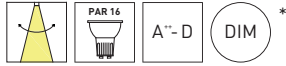

CODE	TYPE	COLOUR	LAMP	POWER SUPPLY
D632	REED	white/black	1xGU10 LED or 1x30W halogen	230 V
D633	REED	white/gold	1xGU10 LED or 1x30W halogen	230 V
D622	REED	black/black	1xGU10 LED or 1x30W halogen	230 V
D623	REED	black/gold	1xGU10 LED or 1x30W halogen	230 V

REED AB

Strahler 230 V mit Baldachin, mit tiefer gesetztem Leuchtmittel, dreh- und schwenkbar (350°/90°), Gehäuse aus Aluminiumdruckguss, für LED- und Halogen-Leuchtmittel geeignet, Entblendungsring wahlweise gold oder schwarz

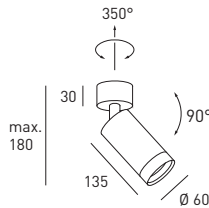

Spotlight 230 V with canopy, with recessed illuminant, adjustable (350°/90°), housing made of die-cast aluminium, LED and halogen lamps are suitable, anti glare ring optionally gold or black

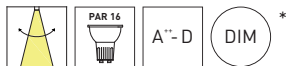

CODE	TYPE	COLOUR	LAMP	POWER SUPPLY
D652	REED AB	white/black	1xGU10 LED or 1x30W halogen	230 V
D653	REED AB	white/gold	1xGU10 LED or 1x30W halogen	230 V
D642	REED AB	black/black	1xGU10 LED or 1x30W halogen	230 V
D643	REED AB	black/gold	1xGU10 LED or 1x30W halogen	230 V

ACCESSORIES

Montageplatte (optional) für REED AB
Mounting plate (optional) for REED AB

CODE	TYPE	COLOUR
D110	REED MOUNTING PLATE	white
D109	REED MOUNTING PLATE	black



COLOURS

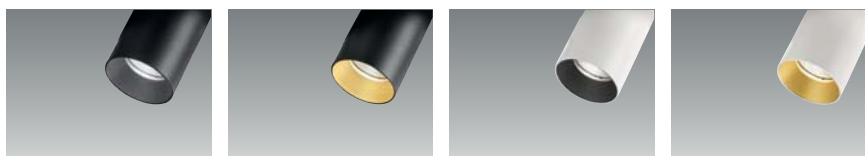

black/black

black/gold

white/black

white/gold

REED P1

Strahler 230 V mit tiefer gesetztem Leuchtmittel, dreh- und schwenkbar (350°/90°), Gehäuse aus Aluminiumdruckguss, für LED- und Halogen-Leuchtmittel geeignet, Entblendungsring wahlweise gold oder schwarz, mit Global 1-Phasenadapter

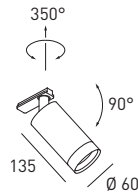

Spotlight 230 V with recessed illuminant, adjustable (350°/90°), housing made of die-cast aluminium, LED and halogen lamps are suitable, anti glare ring optionally gold or black, with Global 1-phase adapter

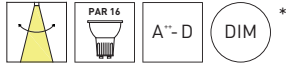

CODE	TYPE	COLOUR	LAMP	POWER SUPPLY
D567	REED P1	white/black	1xGU10 LED or 1x30W halogen	230 V
D568	REED P1	white/gold	1xGU10 LED or 1x30W halogen	230 V
D563	REED P1	black/black	1xGU10 LED or 1x30W halogen	230 V
D564	REED P1	black/gold	1xGU10 LED or 1x30W halogen	230 V

1-Phasen & 3-Phasen Stromschienen und -zubehör siehe S. 190 ff.
1-phase & 3-phase lighting tracks and accessories see page 190 ff.



Architekt: GDC Innenarchitektur / Foto: Hannes Buchinger

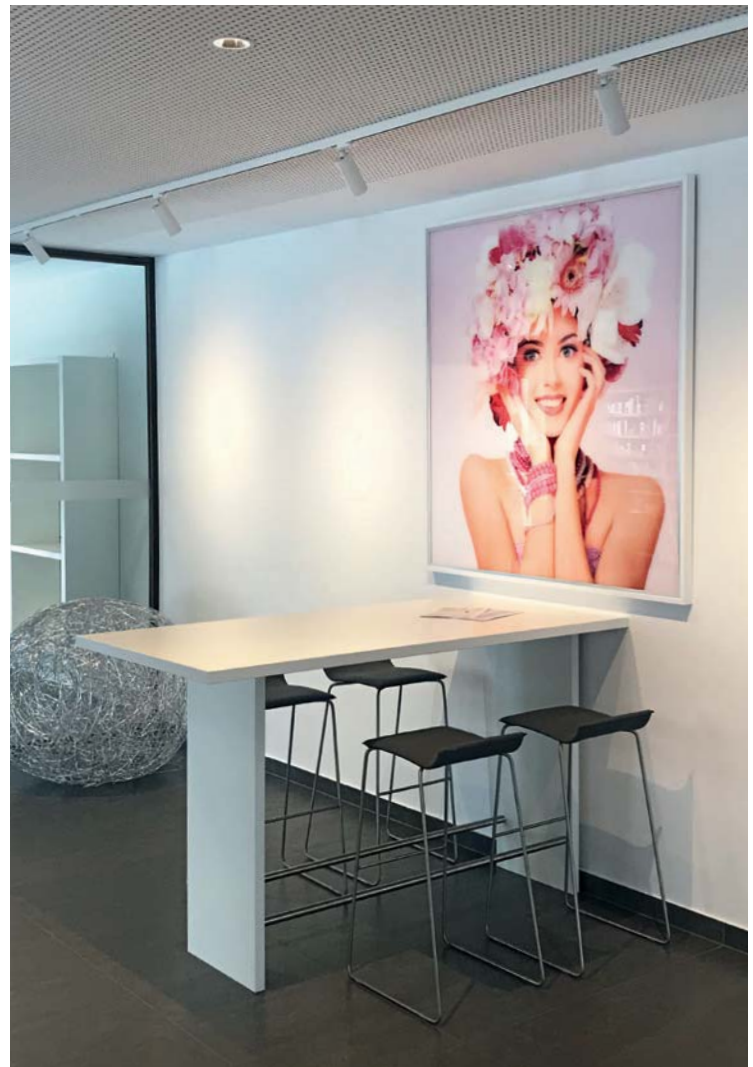

LUCY

LED-Strahler 10 W, CRI>90, mit hocheffizientem Aluminiumreflektor und Entblendungskonus, Gehäuse aus Aluminiumdruckguss, drehbar und schwenkbar (350°/90°), 3-Phasen-Universaladapter mit eingebautem Driver

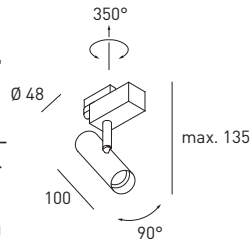

LED-spotlight 10 W, CRI>90, with high output aluminium reflector and anti glare cone, housing made of die-cast aluminium, adjustable (350°/90°), 3-phase universal adapter with built-in driver

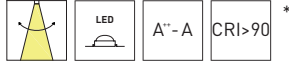

CODE	TYPE	COLOUR	LAMP	LUMEN*	POWER SUPPLY
D762-__	LUCY	white	1x10W LED □ 2700K	935 lm	incl. driver
D772-__	LUCY	black	1x10W LED □ 2700K	935 lm	incl. driver
D722-__	LUCY	white	1x10W LED □ 3000K	970 lm	incl. driver
D719-__	LUCY	black	1x10W LED □ 3000K	970 lm	incl. driver

3-Phasen Stromschienen und -zubehör siehe S. 192 ff.
3-phase lighting tracks and accessories see page 192 ff.

LUCY EP

LED-Einbaustrahler 10 W, CRI>90, mit Einbauplatte, hocheffizientem Aluminiumreflektor und Entblendungskonus, Gehäuse aus Aluminiumdruckguss, dreh- und schwenkbar (350°/90°), Driver bitte separat bestellen

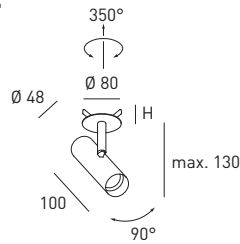

LED-recessed spotlight 10 W, CRI>90, with recessed plate, high output aluminium reflector and anti glare cone, housing made of die-cast aluminium, adjustable (350°/90°), please order driver separately

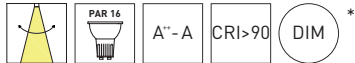

CODE	TYPE	COLOUR	LAMP	LUMEN*	POWER SUPPLY	H
D891-__	LUCY EP	white	1x10W LED □ 2700K 500mA	1040 lm	excl. driver	45 mm
D894-__	LUCY EP	black	1x10W LED □ 2700K 500mA	1040 lm	excl. driver	45 mm
D922-__	LUCY EP	white	1x10W LED □ 3000K 500mA	1080 lm	excl. driver	45 mm
D919-__	LUCY EP	black	1x10W LED □ 3000K 500mA	1080 lm	excl. driver	45 mm

** Deckenstärke < 5 mm = Ausschnitt 50 mm / ** Ceiling dimension < 5 mm = Cut out 50 mm

H = Einbautiefe / recessed depth

Driver siehe Seite 195 ff. / Driver see page 195 ff.

BEAM ANGLE



Bitte wählen Sie den Abstrahlwinkel aus: / Please choose the beam angle:

CODE	BEAM ANGLE
Dxxx-18	18°
Dxxx-38	38° (standard)
Dxxx-60	60°



LINEA 1

LED-Einbaustrahler 2 W, CRI>95, mit hochwertigem Aluminiumreflektor, Driver bitte separat bestellen



LED-recessed downlight 2 W, CRI>95, with high-quality aluminium reflector, please order driver separately

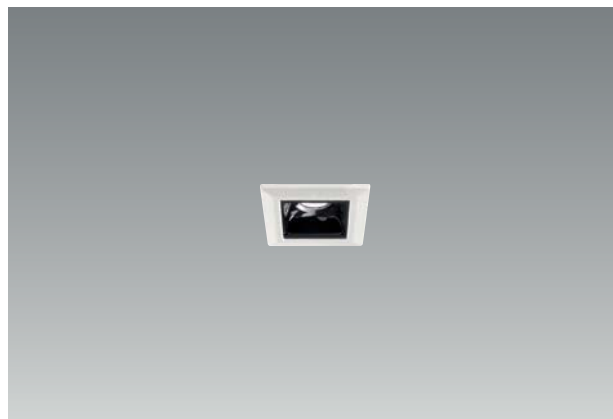
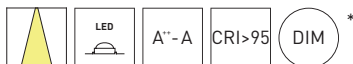

CODE	TYPE	COLOUR	LAMP	LUMEN*	POWER SUPPLY	H
D265	LINEA 1	white	1x2W LED 34° □ 2700K 700mA	180 lm	excl. driver	55 mm
D263	LINEA 1	black	1x2W LED 34° □ 2700K 700mA	180 lm	excl. driver	55 mm
D501	LINEA 1	white	1x2W LED 34° □ 3000K 700mA	190 lm	excl. driver	55 mm
D500	LINEA 1	black	1x2W LED 34° □ 3000K 700mA	190 lm	excl. driver	55 mm

12° Abstrahlwinkel auf Anfrage / 12° beam angle on request

H = Einbautiefe / recessed depth

LINEA 5

LED-Einbaustrahler 10 W, CRI>95, mit hochwertigem Aluminiumreflektor, Driver bitte separat bestellen

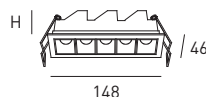

LED-recessed downlight 10 W, CRI>95, with high-quality aluminium reflector, please order driver separately

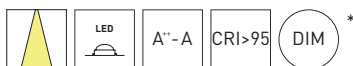

CODE	TYPE	COLOUR	LAMP	LUMEN*	POWER SUPPLY	H
D277	LINEA 5	white	5x2W LED 48° □ 2700K 700mA	5x180 lm	excl. driver	55 mm
D276	LINEA 5	black	5x2W LED 48° □ 2700K 700mA	5x180 lm	excl. driver	55 mm
D533	LINEA 5	white	5x2W LED 48° □ 3000K 700mA	5x190 lm	excl. driver	55 mm
D532	LINEA 5	black	5x2W LED 48° □ 3000K 700mA	5x190 lm	excl. driver	55 mm

12° und 34° Abstrahlwinkel auf Anfrage / 12° and 34° beam angle on request

H = Einbautiefe / recessed depth

LINEA 10

LED-Einbaustrahler 20 W, CRI>95, mit hochwertigem Aluminiumreflektor, Driver bitte separat bestellen

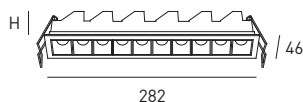

LED-recessed downlight 20 W, CRI>95, with high-quality aluminium reflector, please order driver separately

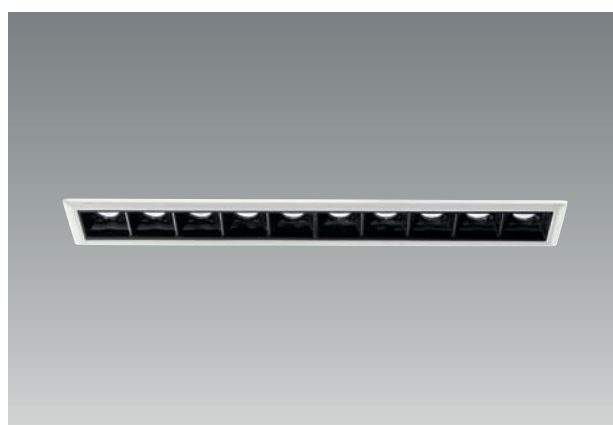
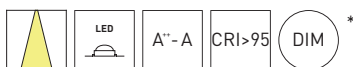

CODE	TYPE	COLOUR	LAMP	LUMEN*	POWER SUPPLY	H
D272	LINEA 10	white	10x2W LED 48° □ 2700K 700mA	10x180 lm	excl. driver	55 mm
D271	LINEA 10	black	10x2W LED 48° □ 2700K 700mA	10x180 lm	excl. driver	55 mm
D354	LINEA 10	white	10x2W LED 48° □ 3000K 700mA	10x190 lm	excl. driver	55 mm
D353	LINEA 10	black	10x2W LED 48° □ 3000K 700mA	10x190 lm	excl. driver	55 mm

12° und 34° Abstrahlwinkel auf Anfrage / 12° and 34° beam angle on request

H = Einbautiefe / recessed depth

Driver siehe Seite 195 ff. / Driver see page 195 ff.

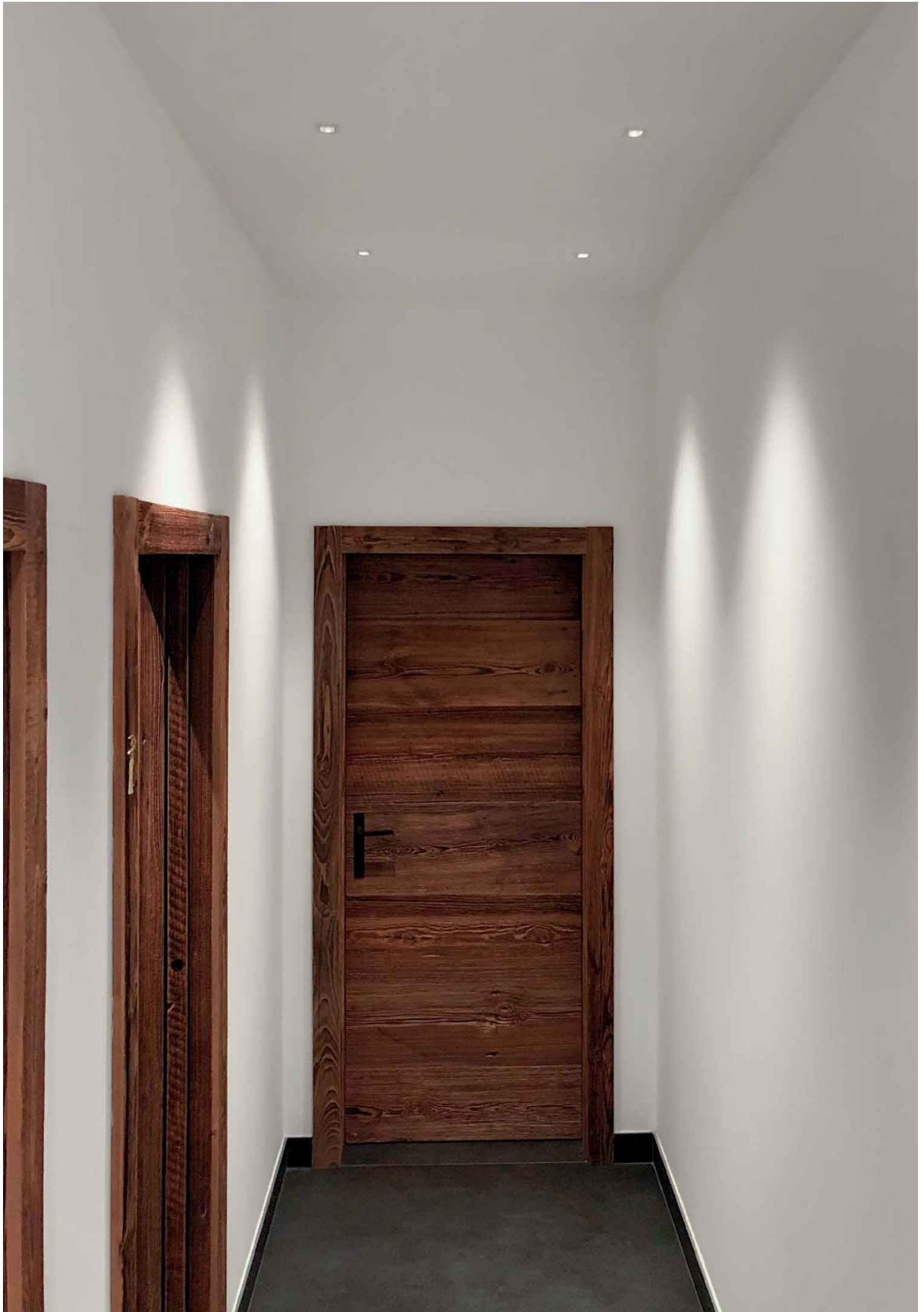

LINEA 5 FLEX

LED-Einbaustrahler 10 W, CRI>95, schwenkbar (2x30°), mit hochwertigem Aluminiumreflektor, Driver bitte separat bestellen

LED-recessed downlight 10 W, CRI>95, adjustable (2x30°), with high-quality aluminium reflector, please order driver separately

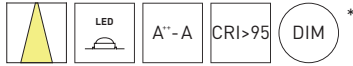
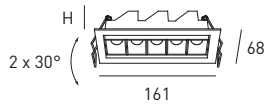

CODE	TYPE	COLOUR	LAMP	LUMEN*	POWER SUPPLY	H
D267	LINEA 5 FLEX	white	5x2W LED 48° □ 2700K 700mA	5x180 lm	excl. driver	55 mm
D266	LINEA 5 FLEX	black	5x2W LED 48° □ 2700K 700mA	5x180 lm	excl. driver	55 mm
D535	LINEA 5 FLEX	white	5x2W LED 48° □ 3000K 700mA	5x190 lm	excl. driver	55 mm
D534	LINEA 5 FLEX	black	5x2W LED 48° □ 3000K 700mA	5x190 lm	excl. driver	55 mm

12° und 34° Abstrahlwinkel auf Anfrage / 12° and 34° beam angle on request

H = Einbautiefe / recessed depth

LINEA WALLWASHER

LED-Einbaustrahler 16 W, CRI>95, mit speziellem Wallwash-Reflektor für eine homogene Beleuchtung an der Wand, Driver bitte separat bestellen

LED-recessed downlight 16 W, CRI>95, with a special wall wash reflector for a excellent uniformity wall illumination, please order driver separately

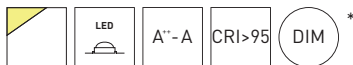
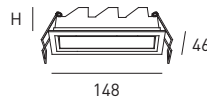

CODE	TYPE	COLOUR	LAMP	LUMEN*	POWER SUPPLY	H
D275	LINEA WALLWASHER	white	16W LED □ 2700K 700mA	1360 lm	excl. driver	55 mm
D273	LINEA WALLWASHER	black	16W LED □ 2700K 700mA	1360 lm	excl. driver	55 mm
D537	LINEA WALLWASHER	white	16W LED □ 3000K 700mA	1430 lm	excl. driver	55 mm
D536	LINEA WALLWASHER	black	16W LED □ 3000K 700mA	1430 lm	excl. driver	55 mm

H = Einbautiefe / recessed depth



Driver siehe Seite 195 ff. / Driver see page 195 ff.

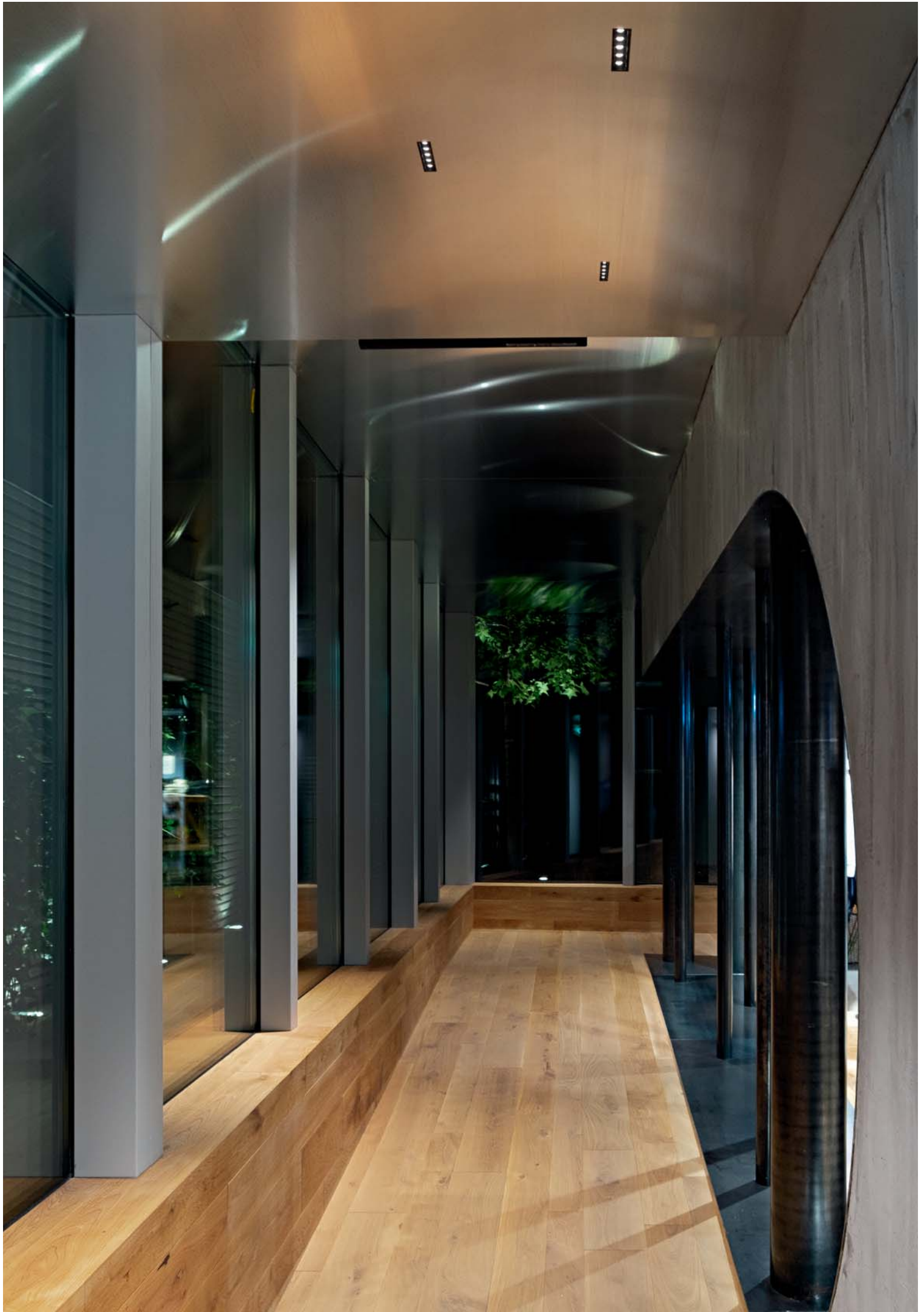

LEDA

LED-Einbaustrahler 2,4 W, CRI>90, Gehäuse aus massivem Aluminium, mit Linsenoptik 30°, schwenkbar 2x30°, Driver bitte separat bestellen

LED-recessed fixture 2,4 W, CRI>90, housing made of aluminium, with 30° lens, adjustable 2x30°, please order driver separately

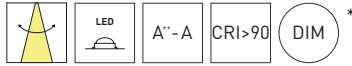

CODE	TYPE	COLOUR	LAMP	LUMEN*	POWER SUPPLY	H
D290	LEDA	white	1x2,4W LED 30° □ 3000K 700mA	170 lm	excl. driver	35 mm
D296	LEDA	black	1x2,4W LED 30° □ 3000K 700mA	170 lm	excl. driver	35 mm
D289	LEDA	alu	1x2,4W LED 30° □ 3000K 700mA	170 lm	excl. driver	35 mm

H = Einbautiefe / recessed depth

MICRO

LED-Einbaustrahler 2,3 W mit extra tiefer gesetzter LED, Gehäuse aus massivem Aluminium, dreh- und schwenkbar (350°/2x30°), Driver bitte separat bestellen

LED-recessed downlight 2,3 W, with recessed illuminant, housing made of aluminium, adjustable (350°/2x30°), please order driver separately

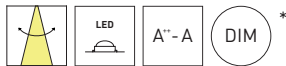

CODE	TYPE	COLOUR	LAMP	LUMEN*	POWER SUPPLY	H
D928-08	MICRO	white	1x2,3W LED 8° □ 2700K 700mA	182 lm	excl. driver	85 mm
D928-24	MICRO	white	1x2,3W LED 24° □ 2700K 700mA	182 lm	excl. driver	85 mm
D929-08	MICRO	black	1x2,3W LED 8° □ 2700K 700mA	182 lm	excl. driver	85 mm
D929-24	MICRO	black	1x2,3W LED 24° □ 2700K 700mA	182 lm	excl. driver	85 mm

H = Einbautiefe / recessed depth

MICRO Q

LED-Einbaustrahler 2,3 W mit extra tiefer gesetzter LED, Gehäuse aus massivem Aluminium, dreh- und schwenkbar (350°/2x30°), Driver bitte separat bestellen

LED-recessed downlight 2,3 W, with recessed illuminant, housing made of aluminium, adjustable (350°/2x30°), please order driver separately

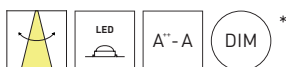

CODE	TYPE	COLOUR	LAMP	LUMEN*	POWER SUPPLY	H
D958-08	MICRO Q	white	1x2,3W LED 8° □ 2700K 700mA	182 lm	excl. driver	85 mm
D958-24	MICRO Q	white	1x2,3W LED 24° □ 2700K 700mA	182 lm	excl. driver	85 mm
D959-08	MICRO Q	black	1x2,3W LED 8° □ 2700K 700mA	182 lm	excl. driver	85 mm
D959-24	MICRO Q	black	1x2,3W LED 24° □ 2700K 700mA	182 lm	excl. driver	85 mm

H = Einbautiefe / recessed depth

Driver siehe Seite 195 ff. / Driver see page 195 ff.

Z000M

LED-Einbaustrahler 2 W, CRI>90, mit hochwertiger Glasoptik, Abstrahlwinkel fokussierbar von 15° bis 60°, schwenkbar (2x25°), Driver bitte separat bestellen

LED-recessed fixture 2 W, CRI>90, with high-quality glass lens, focusable from 15° to 60°, adjustable (2x25°), please order driver separately

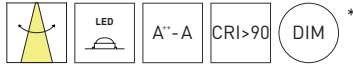
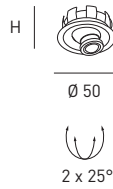

CODE	TYPE	COLOUR	LAMP	LUMEN*	POWER SUPPLY	H
131-09-00-03	Z000M	white	1x2W LED 15°-60° ■ 3000K 500mA	190 lm	excl. driver	27 mm
131-09-00-05	Z000M	black	1x2W LED 15°-60° ■ 3000K 500mA	190 lm	excl. driver	27 mm
131-09-00-01	Z000M	chrome	1x2W LED 15°-60° ■ 3000K 500mA	190 lm	excl. driver	27 mm
131-09-00-33	Z000M	platinum	1x2W LED 15°-60° ■ 3000K 500mA	190 lm	excl. driver	27 mm

2700K und 4000K LED auf Anfrage / 2700K and 4000K LED on request

H = Einbautiefe / recessed depth

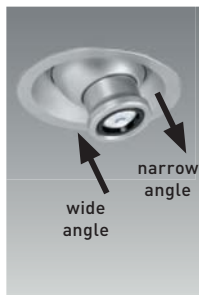

Z000M-Leuchten sind von 15° bis 60° stufenlos fokussierbar

Z000M luminaires are continuously focusable from 15° to 60°

Driver siehe Seite 195 ff. / Driver see page 195 ff.

* Technische Informationen siehe Seite 189 / Lumenangaben sind Nominalwerte - * Technical information see page 189 / Lumen data are nominal data



RENA

Einbaustrahler aus Aluminium, schwenkbar (2x30°), mit tiefer gesetztem Leuchtmittel:

- 1) mit dim to warm LED 12,6 W, CRI>90, LED-Modul austauschbar, Driver bitte separat bestellen
- 2) mit LED 9,3 W, 2700K oder 3000K, CRI>90, dimmbar, LED-Modul austauschbar, Driver bitte separat bestellen
- 3) für GU10 LED- und Halogen-Leuchtmittel geeignet



Recessed downlight made of aluminium, adjustable (2x30°), with recessed lamp:

- 1) with dim to warm LED 12,6 W, CRI>90, LED module replaceable, please order driver separately
- 2) with LED 9,3 W, 2700K or 3000K, CRI>90, dimmable, LED module replaceable, please order driver separately
- 3) GU10 LED and halogen lamps are suitable



CODE	TYPE	COLOUR	LAMP	LUMEN*	POWER SUPPLY	H
D575-__	RENA	white	1x12,6W LED dim to warm 350mA	80-1175 lm	excl. driver	115 mm
D579-__	RENA	black	1x12,6W LED dim to warm 350mA	80-1175 lm	excl. driver	115 mm
D869-__	RENA	white	1x9,3W LED 2700K 500mA	860 lm	excl. driver	110 mm
D866-__	RENA	black	1x9,3W LED 2700K 500mA	860 lm	excl. driver	110 mm
D863-__	RENA	white	1x9,3W LED 3000K 500mA	880 lm	excl. driver	110 mm
D883-__	RENA	black	1x9,3W LED 3000K 500mA	880 lm	excl. driver	110 mm
D583	RENA	white	1xGU10 LED or 1x30W halogen	-	230 V	140 mm
D584	RENA	black	1xGU10 LED or 1x30W halogen	-	230 V	140 mm

H = Einbautiefe / recessed depth

BEAM ANGLE

Bitte wählen Sie den Abstrahlwinkel aus: / Please choose the beam angle:



CODE	LED-MODULE	BEAM ANGLE
Dxxx-15	9,3 W / 12,6 W	15°
Dxxx-25	9,3 W / 12,6 W	25°
Dxxx-38	9,3 W / 12,6 W	38° (standard)
Dxxx-60	9,3 W / 12,6 W	60°

Dim to warm Information siehe S. 197
Dim to warm information see page 197

ACCESSORIES



Snoot für RENA
Snoot for RENA

CODE	TYPE	HxØ	COLOUR
D120	SNOOT	32xØ48 mm	white
D121	SNOOT	32xØ48 mm	black

Driver siehe Seite 195 ff. / Driver see page 195 ff.



Projekt: Hotel Waldruhe Kartitsch



Lichtplanung: Nataly Hofer / Foto: Eckli Raff

CREDO

Einbaustrahler aus Aluminium, dreh- und schwenkbar (350°/2x30°), mit tiefer gesetztem Leuchtmittel:
 1) mit dim to warm LED 12,6 W, CRI>90, LED-Modul austauschbar, Driver bitte separat bestellen
 2) mit LED 9,3 W oder 14W, 2700K oder 3000K, CRI>90, dimmbar, LED-Modul austauschbar, Driver bitte separat bestellen
 3) für GU10 LED- und Halogen-Leuchtmittel geeignet

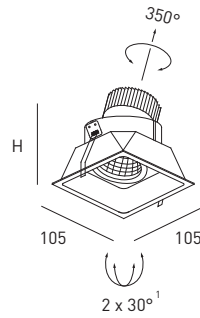

Recessed downlight made of aluminium, adjustable (350°/2x30°), with recessed lamp:
 1) with dim to warm LED 12,6 W, CRI>90, LED module replaceable, please order driver separately
 2) with LED 9,3 W or 14 W, 2700K or 3000K, CRI>90, dimmable, LED module replaceable, please order driver separately
 3) GU10 LED and halogen lamps are suitable

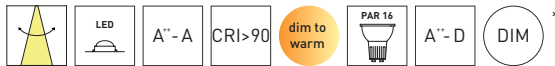

CODE	TYPE	COLOUR	LAMP	LUMEN*	POWER SUPPLY	H
D545-__	CREDO	white	1x12,6W LED dim to warm 350mA	80-1175 lm	excl. driver	115 mm
D549-__	CREDO	black	1x12,6W LED dim to warm 350mA	80-1175 lm	excl. driver	115 mm
D901-__	CREDO	white	1x14W LED 2700K 500mA ¹	1340 lm	excl. driver	135 mm
D910-__	CREDO	black	1x14W LED 2700K 500mA ¹	1340 lm	excl. driver	135 mm
D923-__	CREDO	white	1x14W LED 3000K 500mA ¹	1395 lm	excl. driver	135 mm
D984-__	CREDO	black	1x14W LED 3000K 500mA ¹	1395 lm	excl. driver	135 mm
D879-__	CREDO	white	1x9,3W LED 2700K 500mA	860 lm	excl. driver	110 mm
D876-__	CREDO	black	1x9,3W LED 2700K 500mA	860 lm	excl. driver	110 mm
D873-__	CREDO	white	1x9,3W LED 3000K 500mA	880 lm	excl. driver	110 mm
D889-__	CREDO	black	1x9,3W LED 3000K 500mA	880 lm	excl. driver	110 mm
D587	CREDO	white	1xGU10 LED or 1x30W halogen	-	230 V	140 mm
D588	CREDO	black	1xGU10 LED or 1x30W halogen	-	230 V	140 mm

¹mit 14 W LED-Modul: schwenkbar 350°/2x20° / ¹with 14 W LED module: adjustable 350°/2x20°

H = Einbautiefe / recessed depth

BEAM ANGLE

Bitte wählen Sie den Abstrahlwinkel aus: / Please choose the beam angle:



CODE	LED-MODULE	BEAM ANGLE
Dxxx-15	9,3 W / 12,6 W	15°
Dxxx-25	9,3 W / 12,6 W	25°
Dxxx-38	9,3 W / 12,6 W	38° (standard)
Dxxx-60	9,3 W / 12,6 W	60°
Dxxx-15	14 W	15°
Dxxx-25	14 W	25°
Dxxx-38	14 W	38° (standard)

Dim to warm Information siehe S. 197
 Dim to warm information see page 197

ACCESSORIES

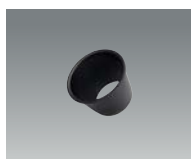

Snoot für CREDO
 Snoot for CREDO

CODE	TYPE	HxØ	COLOUR
D120	SNOOT	32xØ48 mm	white
D121	SNOOT	32xØ48 mm	black

Driver siehe Seite 195 ff. / Driver see page 195 ff.



KYO

Einbaustrahler aus Aluminium, schwenkbar (2x30°), mit tiefer gesetztem Leuchtmittel und Entblendungsring:
 1) mit dim to warm LED 12,6 W, CRI>90, LED-Modul austauschbar, Driver bitte separat bestellen
 2) mit LED 9,3 W oder 14W, 2700K oder 3000K, CRI>90, dimmbar, LED-Modul austauschbar, Driver bitte separat bestellen
 3) für GU10 LED- und Halogen-Leuchtmittel geeignet



Recessed downlight made of aluminium, adjustable (2x30°), with recessed lamp and anti glare ring:
 1) with dim to warm LED 12,6 W, CRI>90, LED module replaceable, please order driver separately
 2) with LED 9,3 W or 14 W, 2700K or 3000K, CRI>90, dimmable, LED module replaceable, please order driver separately
 3) GU10 LED and halogen lamps are suitable

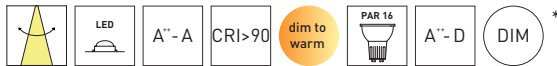

CODE	TYPE	COLOUR	LAMP	LUMEN*	POWER SUPPLY	H
D465-__	KYO	white	1x12,6W LED dim to warm 350mA	80-1175 lm	excl. driver	95 mm
D469-__	KYO	black	1x12,6W LED dim to warm 350mA	80-1175 lm	excl. driver	95 mm
D405-__	KYO	white	1x14W LED 2700K 500mA	1340 lm	excl. driver	115 mm
D408-__	KYO	black	1x14W LED 2700K 500mA	1340 lm	excl. driver	115 mm
D409-__	KYO	white	1x14W LED 3000K 500mA	1395 lm	excl. driver	115 mm
D410-__	KYO	black	1x14W LED 3000K 500mA	1395 lm	excl. driver	115 mm
D859-__	KYO	white	1x9,3W LED 2700K 500mA	860 lm	excl. driver	90 mm
D856-__	KYO	black	1x9,3W LED 2700K 500mA	860 lm	excl. driver	90 mm
D853-__	KYO	white	1x9,3W LED 3000K 500mA	880 lm	excl. driver	90 mm
D886-__	KYO	black	1x9,3W LED 3000K 500mA	880 lm	excl. driver	90 mm
D403	KYO	white	1xGU10 LED or 1x30W halogen	-	230 V	120 mm
D404	KYO	black	1xGU10 LED or 1x30W halogen	-	230 V	120 mm

H = Einbautiefe / recessed depth

BEAM ANGLE

Bitte wählen Sie den Abstrahlwinkel aus: / Please choose the beam angle:



CODE	LED-MODULE	BEAM ANGLE
Dxxx-15	9,3 W / 12,6 W	15°
Dxxx-25	9,3 W / 12,6 W	25°
Dxxx-38	9,3 W / 12,6 W	38° (standard)
Dxxx-60	9,3 W / 12,6 W	60°
Dxxx-15	14 W	15°
Dxxx-25	14 W	25°
Dxxx-38	14 W	38° (standard)

Dim to warm Information siehe S. 197
 Dim to warm information see page 197

Driver siehe Seite 195 ff. / Driver see page 195 ff.



Foto: Martin Steinhilber



Foto: Jan Haeselich

OPUS

Einbaustrahler für randlosen Einbau, aus Aluminium, dreh- und schwenkbar (360°/2x30°), mit tiefer gesetztem Leuchtmittel, inkl. Einbaurahmen:

- 1) mit dim to warm LED 12,6 W, CRI>90, LED-Modul austauschbar, Driver bitte separat bestellen
- 2) mit LED 9,3 W, 2700K oder 3000K, CRI>90, dimmbar, LED-Modul austauschbar, Driver bitte separat bestellen
- 3) für GU10 LED- und Halogen-Leuchtmittel geeignet

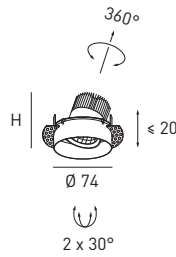

Recessed downlight for trimless assembly, made of aluminium, adjustable (360°/2x30°), with recessed lamp, including recessed frame:

- 1) with dim to warm LED 12,6 W, CRI>90, LED module replaceable, please order driver separately
- 2) with LED 9,3 W, 2700K or 3000K, CRI>90, dimmable, LED module replaceable, please order driver separately
- 3) GU10 LED and halogen lamps are suitable

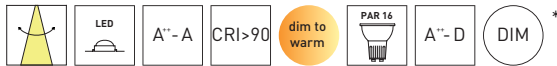

CODE	TYPE	COLOUR	LAMP	LUMEN*	POWER SUPPLY	H
D424-__	OPUS	white	1x12,6W LED dim to warm 350mA	80-1175 lm	excl. driver	105 mm
D425-__	OPUS	black	1x12,6W LED dim to warm 350mA	80-1175 lm	excl. driver	105 mm
D426-__	OPUS	white	1x9,3W LED 2700K 500mA	860 lm	excl. driver	100 mm
D427-__	OPUS	black	1x9,3W LED 2700K 500mA	860 lm	excl. driver	100 mm
D428-__	OPUS	white	1x9,3W LED 3000K 500mA	880 lm	excl. driver	100 mm
D429-__	OPUS	black	1x9,3W LED 3000K 500mA	880 lm	excl. driver	100 mm
D434	OPUS	white	1xGU10 LED or 1x30W halogen	-	230 V	130 mm
D435	OPUS	black	1xGU10 LED or 1x30W halogen	-	230 V	130 mm

H = Einbautiefe / recessed depth

BEAM ANGLE

Bitte wählen Sie den Abstrahlwinkel aus: / Please choose the beam angle:



CODE	LED-MODULE	BEAM ANGLE
Dxxx-15	9,3 W/12,6 W	15°
Dxxx-25	9,3 W/12,6 W	25°
Dxxx-38	9,3 W/12,6 W	38° (standard)
Dxxx-60	9,3 W/12,6 W	60°

Dim to warm Information siehe S. 197
Dim to warm information see page 197

Driver siehe Seite 195 ff. / Driver see page 195 ff.

OPUS Q

Einbaustrahler für randlosen Einbau, aus Aluminium, dreh- und schwenkbar (360°/2x30°), mit tiefer gesetztem Leuchtmittel, inkl. Einbaurahmen:

- 1) mit dim to warm LED 12,6 W, CRI>90, LED-Modul austauschbar, Driver bitte separat bestellen
- 2) mit LED 9,3 W, 2700K oder 3000K, CRI>90, dimmbar, LED-Modul austauschbar, Driver bitte separat bestellen
- 3) für GU10 LED- und Halogen-Leuchtmittel geeignet

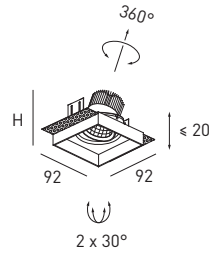

Recessed downlight for trimless assembly, made of aluminium, adjustable (360°/2x30°), with recessed lamp, including recessed frame:

- 1) with dim to warm LED 12,6 W, CRI>90, LED module replaceable, please order driver separately
- 2) with LED 9,3 W, 2700K or 3000K, CRI>90, dimmable, LED module replaceable, please order driver separately
- 3) GU10 LED and halogen lamps are suitable

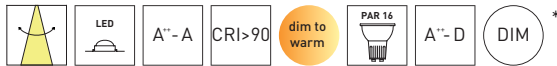

CODE	TYPE	COLOUR	LAMP	LUMEN*	POWER SUPPLY	H
D443-__	OPUS Q	white	1x12,6W LED dim to warm 350mA	80-1175 lm	excl. driver	105 mm
D444-__	OPUS Q	black	1x12,6W LED dim to warm 350mA	80-1175 lm	excl. driver	105 mm
D445-__	OPUS Q	white	1x9,3W LED 2700K 500mA	860 lm	excl. driver	100 mm
D446-__	OPUS Q	black	1x9,3W LED 2700K 500mA	860 lm	excl. driver	100 mm
D447-__	OPUS Q	white	1x9,3W LED 3000K 500mA	880 lm	excl. driver	100 mm
D448-__	OPUS Q	black	1x9,3W LED 3000K 500mA	880 lm	excl. driver	100 mm
D449	OPUS Q	white	1xGU10 LED or 1x30W halogen	-	230 V	130 mm
D450	OPUS Q	black	1xGU10 LED or 1x30W halogen	-	230 V	130 mm

H = Einbautiefe / recessed depth

BEAM ANGLE

Bitte wählen Sie den Abstrahlwinkel aus: / Please choose the beam angle:



CODE	LED-MODULE	BEAM ANGLE
Dxxx-15	9,3 W/12,6 W	15°
Dxxx-25	9,3 W/12,6 W	25°
Dxxx-38	9,3 W/12,6 W	38° (standard)
Dxxx-60	9,3 W/12,6 W	60°

Dim to warm Information siehe S. 197
Dim to warm information see page 197

Driver siehe Seite 195 ff. / Driver see page 195 ff.

RIGA

Einbaustrahler aus Aluminium, schwenkbar (2x30°):
 1) mit dim to warm LED 12,6 W, CRI>90, LED-Modul austauschbar, Driver bitte separat bestellen
 2) mit LED 9,3 W, 2700K oder 3000K, CRI>90, dimmbar, LED-Modul austauschbar, Driver bitte separat bestellen
 3) für GU10 LED- und Halogen-Leuchtmittel geeignet

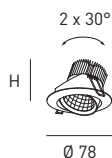

Recessed downlight made of aluminium, adjustable (2x30°):
 1) with dim to warm LED 12,6 W, CRI>90, LED module replaceable, please order driver separately
 2) with LED 9,3 W, 2700K or 3000K, CRI>90, dimmable, LED module replaceable, please order driver separately
 3) GU10 LED and halogen lamps are suitable



CODE	TYPE	COLOUR	LAMP	LUMEN*	POWER SUPPLY	H
D800-__	RIGA	white	1x12,6W LED dim to warm 350mA	80-1175 lm	excl. driver	85 mm
D801-__	RIGA	black	1x12,6W LED dim to warm 350mA	80-1175 lm	excl. driver	85 mm
D802-__	RIGA	white	1x9,3W LED 2700K 500mA	860 lm	excl. driver	80 mm
D803-__	RIGA	black	1x9,3W LED 2700K 500mA	860 lm	excl. driver	80 mm
D804-__	RIGA	white	1x9,3W LED 3000K 500mA	880 lm	excl. driver	80 mm
D805-__	RIGA	black	1x9,3W LED 3000K 500mA	880 lm	excl. driver	80 mm
D806	RIGA	white	1xGU10 LED or 1x30W halogen	-	230 V	110 mm
D807	RIGA	black	1xGU10 LED or 1x30W halogen	-	230 V	110 mm

H = Einbautiefe / recessed depth

BEAM ANGLE

Bitte wählen Sie den Abstrahlwinkel aus: / Please choose the beam angle:



CODE	LED-MODULE	BEAM ANGLE
Dxxx-15	9,3 W / 12,6 W	15°
Dxxx-25	9,3 W / 12,6 W	25°
Dxxx-38	9,3 W / 12,6 W	38° (standard)
Dxxx-60	9,3 W / 12,6 W	60°

Dim to warm Information siehe S. 197
 Dim to warm information see page 197

Driver siehe Seite 195 ff. / Driver see page 195 ff.

RIGA Q

Einbaustrahler aus Aluminium, schwenkbar (2x30°):
 1) mit dim to warm LED 12,6 W, CRI>90, LED-Modul austauschbar, Driver bitte separat bestellen
 2) mit LED 9,3 W, 2700K oder 3000K, CRI>90, dimmbar, LED-Modul austauschbar, Driver bitte separat bestellen
 3) für GU10 LED- und Halogen-Leuchtmittel geeignet

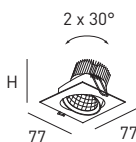

Recessed downlight made of aluminium, adjustable (2x30°):
 1) with dim to warm LED 12,6 W, CRI>90, LED module replaceable, please order driver separately
 2) with LED 9,3 W, 2700K or 3000K, CRI>90, dimmable, LED module replaceable, please order driver separately
 3) GU10 LED and halogen lamps are suitable

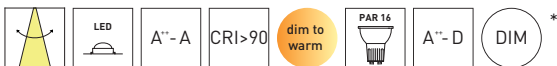

CODE	TYPE	COLOUR	LAMP	LUMEN*	POWER SUPPLY	H
D668-__	RIGA Q	white	1x12,6W LED dim to warm 350mA	80-1175 lm	excl. driver	85 mm
D669-__	RIGA Q	black	1x12,6W LED dim to warm 350mA	80-1175 lm	excl. driver	85 mm
D694-__	RIGA Q	white	1x9,3W LED 2700K 500mA	860 lm	excl. driver	80 mm
D695-__	RIGA Q	black	1x9,3W LED 2700K 500mA	860 lm	excl. driver	80 mm
D696-__	RIGA Q	white	1x9,3W LED 3000K 500mA	880 lm	excl. driver	80 mm
D697-__	RIGA Q	black	1x9,3W LED 3000K 500mA	880 lm	excl. driver	80 mm
D698	RIGA Q	white	1xGU10 LED or 1x30W halogen	-	230 V	110 mm
D699	RIGA Q	black	1xGU10 LED or 1x30W halogen	-	230 V	110 mm

H = Einbautiefe / recessed depth

BEAM ANGLE

Bitte wählen Sie den Abstrahlwinkel aus: / Please choose the beam angle:



CODE	LED-MODULE	BEAM ANGLE
Dxxx-15	9,3 W / 12,6 W	15°
Dxxx-25	9,3 W / 12,6 W	25°
Dxxx-38	9,3 W / 12,6 W	38° (standard)
Dxxx-60	9,3 W / 12,6 W	60°

Dim to warm Information siehe S. 197
 Dim to warm information see page 197

Driver siehe Seite 195 ff. / Driver see page 195 ff.

SQUARE

Einbaustrahler 12 V oder 230 V, 2-fach schwenkbar (2x30°/2x10°), mit Entblendungsring, für 12 V oder 230 V LED- und Halogen-Leuchtmittel geeignet, Transformator bitte separat bestellen

Recessed downlight 12 V and 230 V, adjustable (2x30°/2x10°), with anti glare ring, 12 V or 230 V LED and halogen lamps are suitable, please order transformer separately

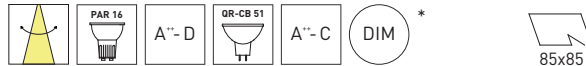
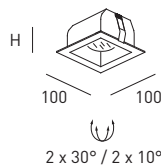

CODE	TYPE	COLOUR	LAMP	POWER SUPPLY	H
D382	SQUARE	white	1xGU10 LED or 1x30W halogen	230 V	105 mm
D381	SQUARE	grey	1xGU10 LED or 1x30W halogen	230 V	105 mm
D480	SQUARE	white	1xGU5,3 LED or 1x35W IRC halogen	excl. transformer	90 mm
D481	SQUARE	grey	1xGU5,3 LED or 1x35W IRC halogen	excl. transformer	90 mm

H = Einbautiefe / recessed depth

SQUARE DUO

2-fach Einbaustrahler 12 V oder 230 V, 2-fach schwenkbar (2x30°/2x10°), mit Entblendungsring, für 12 V oder 230 V LED- und Halogen-Leuchtmittel geeignet, Transformator bitte separat bestellen

Double recessed downlight 12 V und 230 V, adjustable (2x30°/2x10°), with anti glare ring, 12 V or 230 V LED and halogen lamps are suitable, please order transformer separately

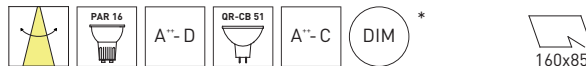
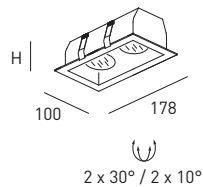

CODE	TYPE	COLOUR	LAMP	POWER SUPPLY	H
D384	SQUARE DUO	white	2xGU10 LED or 2x30W halogen	230 V	105 mm
D383	SQUARE DUO	grey	2xGU10 LED or 2x30W halogen	230 V	105 mm
D482	SQUARE DUO	white	2xGU5,3 LED or 2x35W IRC halogen	excl. transformer	90 mm
D483	SQUARE DUO	grey	2xGU5,3 LED or 2x35W IRC halogen	excl. transformer	90 mm

H = Einbautiefe / recessed depth

Transformatoren siehe Seite 194 / Transformer see page 194







NO FRAME 80

Einbaustrahler 12 V oder 230 V, für rand- und werkzeuglosen Einbau, Leuchtmittel kardanisches gelagert (2x30°), für 12 V oder 230 V LED- und Halogen-Leuchtmittel geeignet, Transformator und Einbau-KIT bitte separat bestellen



Recessed downlight 12 V or 230 V, for trimless assembly, mountable without tools, illuminant gimbal mounted (2x30°), 12 V or 230 V LED and halogen lamps are suitable, please order transformer and recessed frame (KIT) separately

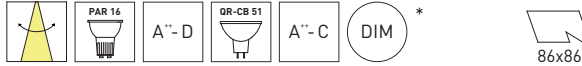

CODE	TYPE	COLOUR	LAMP	POWER SUPPLY	H
D911	NO FRAME 80	white	1xGU10 LED or 1x30W halogen	230 V	140 mm
D912	NO FRAME 80	black	1xGU10 LED or 1x30W halogen	230 V	140 mm
D411	NO FRAME 80	white	1xGU5,3 LED or 1x35W IRC halogen	excl. transformer	120 mm
D412	NO FRAME 80	black	1xGU5,3 LED or 1x35W IRC halogen	excl. transformer	120 mm

H = Einbautiefe / recessed depth

NO FRAME 80 DUO

2-fach Einbaustrahler 12 V oder 230 V für rand- und werkzeuglosen Einbau, Leuchtmittel kardanisches gelagert (2x30°), für 12 V oder 230 V LED- und Halogen-Leuchtmittel geeignet, Transformator und Einbau-KIT bitte separat bestellen

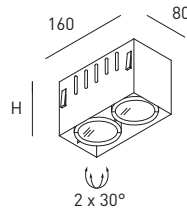

Double recessed downlight 12 V or 230 V, for trimless assembly, mountable without tools, illuminant gimbal mounted (2x30°), 12 V or 230 V LED and halogen lamps are suitable, please order transformer and recessed frame (KIT) separately

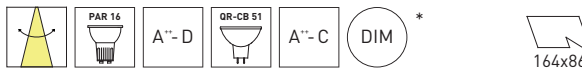

CODE	TYPE	COLOUR	LAMP	POWER SUPPLY	H
D915	NO FRAME 80 DUO	white	2xGU10 LED or 2x30W halogen	230 V	140 mm
D916	NO FRAME 80 DUO	black	2xGU10 LED or 2x30W halogen	230 V	140 mm
D415	NO FRAME 80 DUO	white	2xGU5,3 LED or 2x35W IRC halogen	excl. transformer	120 mm
D416	NO FRAME 80 DUO	black	2xGU5,3 LED or 2x35W IRC halogen	excl. transformer	120 mm

H = Einbautiefe / recessed depth

ACCESSORIES

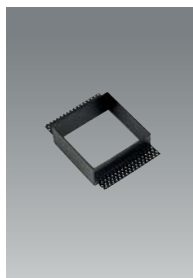

Einbaurahmen für Serie NO FRAME 80 für Gipskartonplatten der Stärke 12,5 mm und 20 mm. Ausgleichsplatten für andere Gipskartonstärken auf Anfrage.

Recessed frame for NO FRAME 80 series for 12,5 mm and 20 mm plasterboards. Compensating plates for other dimensions of plasterboards on request.

CODE	TYPE	COLOUR
D111	KIT 80	white
D112	KIT 80	black
D115	KIT 80 DUO	white
D116	KIT 80 DUO	black

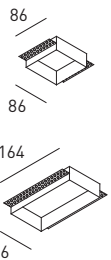

Transformatoren siehe Seite 194 / Transformer see page 194



NO FRAME 150

Einbaustrahler 12 V, für rand- und werkzeuglosen Einbau, Leuchtmittel kardinalisch gelagert (2x30°), für LED- und Halogen-Leuchtmittel geeignet, Transformator und Einbau-KIT bitte separat bestellen

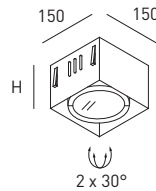

Recessed downlight 12 V, for trimless assembly, mountable without tools, illuminant gimbal mounted (2x30°), LED and halogen lamps are suitable, please order transformer and recessed frame (KIT) separately

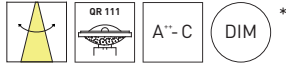

CODE	TYPE	COLOUR	LAMP	POWER SUPPLY	H
D451	NO FRAME 150	white	1xG53 LED or 1x50W IRC halogen	excl. transformer	130 mm
D452	NO FRAME 150	black	1xG53 LED or 1x50W IRC halogen	excl. transformer	130 mm

H = Einbautiefe / recessed depth

NO FRAME 150 DUO

2-fach Einbaustrahler 12 V, für rand- und werkzeuglosen Einbau, Leuchtmittel kardinalisch gelagert (2x30°), für LED- und Halogen-Leuchtmittel geeignet, Transformator und Einbau-KIT bitte separat bestellen

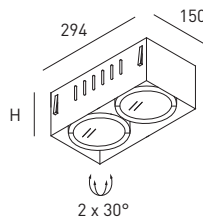

Double recessed downlight 12 V, for trimless assembly, mountable without tools, illuminant gimbal mounted (2x30°), LED and halogen lamps are suitable, please order transformer and recessed frame (KIT) separately

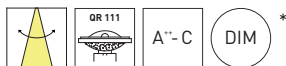

CODE	TYPE	COLOUR	LAMP	POWER SUPPLY	H
D455	NO FRAME 150 DUO	white	2xG53 LED or 2x50W IRC halogen	excl. transformer	130 mm
D456	NO FRAME 150 DUO	black	2xG53 LED or 2x50W IRC halogen	excl. transformer	130 mm

H = Einbautiefe / recessed depth

ACCESSORIES

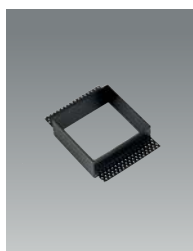

Einbaurahmen für Serie NO FRAME 150 für Gipskartonplatten der Stärke 12,5 mm und 20 mm. Ausgleichsplatten für andere Gipskartonstärken auf Anfrage.
Recessed frame for NO FRAME 150 series for 12,5 mm and 20 mm plasterboards.
Compensating plates for other dimensions of plasterboards on request.

CODE	TYPE	COLOUR
D151	KIT 150	white
D152	KIT 150	black
D155	KIT 150 DUO	white
D156	KIT 150 DUO	black

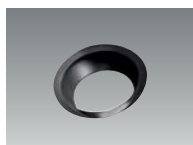
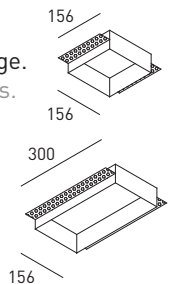

Entblendungskonus für Serie NO FRAME 150
Anti glare cone for NO FRAME 150 series

CODE	TYPE	COLOUR
D158	ANTI GLARE CONE 150	white
D159	ANTI GLARE CONE 150	black



Transformatoren siehe Seite 194 / Transformer see page 194



Architekt: Kamleitner Architekten / Foto: Andrea Ruster



Architekt: Enzo Architekten

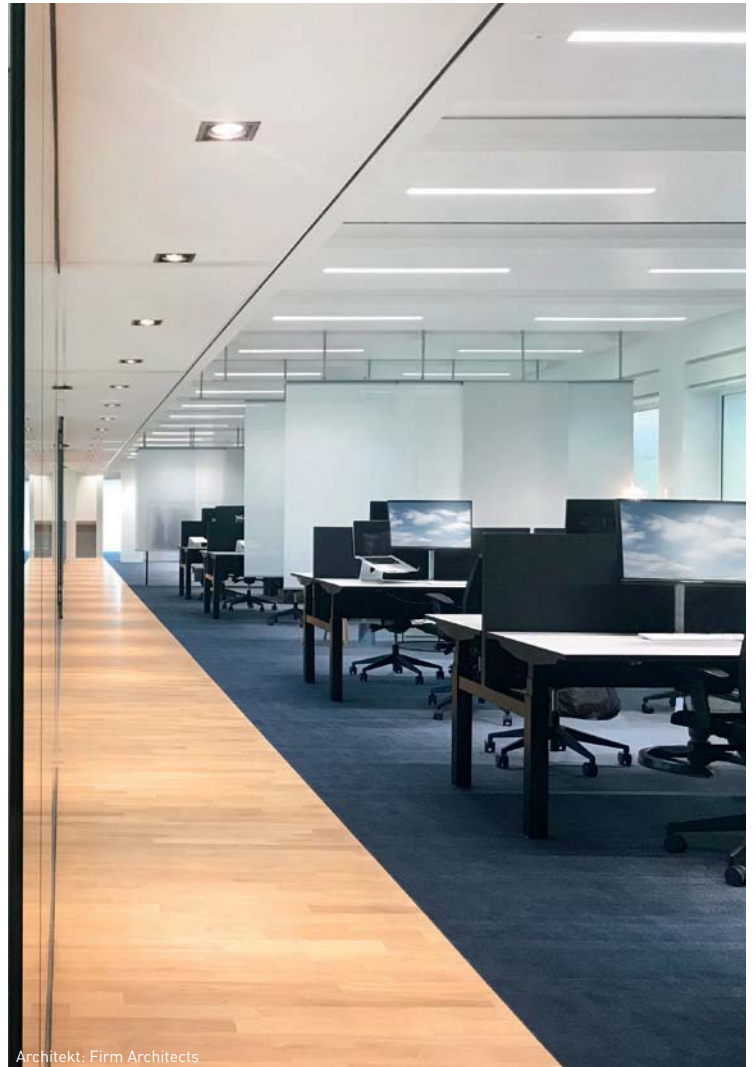

Architekt: Firm Architects

NO FRAME 80 ROUND

Einbaustrahler 12 V oder 230 V, für rand- und werkzeuglosen Einbau, Leuchtmittel kardanisch gelagert (2x30°), für 12 V oder 230 V LED- und Halogen-Leuchtmittel geeignet, Transformator und Einbau-KIT bitte separat bestellen

Recessed downlight 12 V or 230 V, for trimless assembly, mountable without tools, illuminant gimbal mounted (2x30°), 12 V or 230 V LED and halogen lamps are suitable, please order transformer and recessed frame (KIT) separately

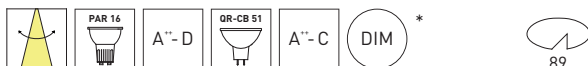

CODE	TYPE	COLOUR	LAMP	POWER SUPPLY	H
D932	NO FRAME 80 ROUND	white	1xGU10 LED or 1x30W halogen	230 V	140 mm
D933	NO FRAME 80 ROUND	black	1xGU10 LED or 1x30W halogen	230 V	140 mm
D432	NO FRAME 80 ROUND	white	1xGU5,3 LED or 1x35W IRC halogen	excl. transformer	120 mm
D433	NO FRAME 80 ROUND	black	1xGU5,3 LED or 1x35W IRC halogen	excl. transformer	120 mm

H = Einbautiefe / recessed depth

NO FRAME 150 ROUND

Einbaustrahler 12 V, für rand- und werkzeuglosen Einbau, Leuchtmittel kardanisch gelagert (2x30°), für LED- und Halogen-Leuchtmittel geeignet, Transformator und Einbau-KIT bitte separat bestellen

Recessed downlight 12 V, for trimless assembly, mountable without tools, illuminant gimbal mounted (2x30°), LED and halogen lamps are suitable, please order transformer and recessed frame (KIT) separately



CODE	TYPE	COLOUR	LAMP	POWER SUPPLY	H
D471	NO FRAME 150 ROUND	white	1xG53 LED or 1x50W IRC halogen	excl. transformer	120 mm
D472	NO FRAME 150 ROUND	black	1xG53 LED or 1x50W IRC halogen	excl. transformer	120 mm

H = Einbautiefe / recessed depth

ACCESSORIES



Einbaurahmen für Serie NO FRAME 80 / 150 ROUND für Gipskartonplatten der Stärke 12,5 mm und 20 mm. Ausgleichsplatten für andere Gipskartonstärken auf Anfrage.
Recessed frame for NO FRAME 80 / 150 ROUND series for 12,5 mm and 20 mm plasterboards. Compensating plates for other dimensions of plasterboards on request.

CODE	TYPE	COLOUR
D117	KIT 80 ROUND	white
D118	KIT 80 ROUND	black
D171	KIT 150 ROUND	white
D172	KIT 150 ROUND	black

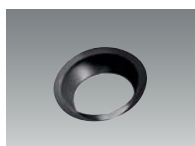
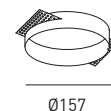

Entblendungskonus für Serie NO FRAME 150
Anti glare cone for NO FRAME 150 series

CODE	TYPE	COLOUR
D158	ANTI GLARE CONE 150	white
D159	ANTI GLARE CONE 150	black



Transformatoren siehe Seite 194 / Transformer see page 194



FRAME 150

Einbaustrahler 12 V, Leuchtmittel kardanisch gelagert (2x30°), für LED- und Halogen-Leuchtmittel geeignet, Transformator bitte separat bestellen

Recessed downlight 12 V, illuminant gimbal mounted (2x30°), LED and halogen lamps are suitable, please order transformer separately

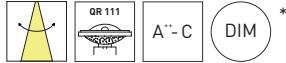
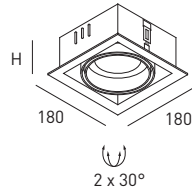

CODE	TYPE	COLOUR	LAMP	POWER SUPPLY	H
D491	FRAME 150	white	1xG53 LED or 1x50W IRC halogen	excl. transformer	105 mm
D492	FRAME 150	black	1xG53 LED or 1x50W IRC halogen	excl. transformer	105 mm

H = Einbautiefe / recessed depth

FRAME 150 DUO

2-fach Einbaustrahler 12 V, Leuchtmittel kardanisch gelagert (2x30°), für LED- und Halogen-Leuchtmittel geeignet, Transformator bitte separat bestellen

Double recessed downlight 12 V, illuminant gimbal mounted (2x30°), LED and halogen lamps are suitable, please order transformer separately

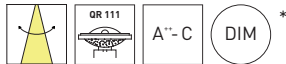
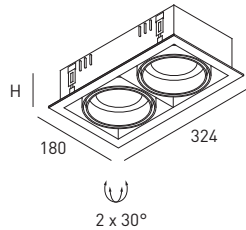

CODE	TYPE	COLOUR	LAMP	POWER SUPPLY	H
D495	FRAME 150 DUO	white	2xG53 LED or 2x50W IRC halogen	excl. transformer	105 mm
D496	FRAME 150 DUO	black	2xG53 LED or 2x50W IRC halogen	excl. transformer	105 mm

H = Einbautiefe / recessed depth

ACCESSORIES



Entblendungskonus für Serie NO FRAME 150
Anti glare cone for NO FRAME 150 series

CODE	TYPE	COLOUR
D158	ANTI GLARE CONE 150	white
D159	ANTI GLARE CONE 150	black



Transformatoren siehe Seite 194 / Transformer see page 194



GANYMED

LED-Einbaustrahler 9,3 W mit hochwertigem Aluminiumreflektor, tiefer gesetzter LED, schwenkbar (2x25°), Entblendungsring wahlweise gold oder schwarz, Driver bitte separat bestellen

LED-recessed downlight 9,3 W with high value aluminium reflector, recessed LED, adjustable (2x25°), anti glare ring optionally gold or black, please order driver separately

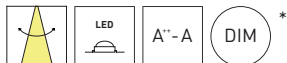
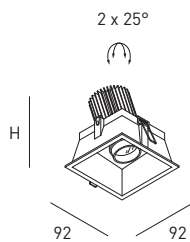

CODE	TYPE	COLOUR	LAMP	LUMEN*	POWER SUPPLY	H
D779	GANYMED	white/black	1x9,3W LED 32° □ 3000K 500mA	1056 lm	excl. driver	140 mm
D774	GANYMED	white/gold	1x9,3W LED 32° □ 3000K 500mA	1056 lm	excl. driver	140 mm
D780	GANYMED	black/black	1x9,3W LED 32° □ 3000K 500mA	1056 lm	excl. driver	140 mm
D776	GANYMED	black/gold	1x9,3W LED 32° □ 3000K 500mA	1056 lm	excl. driver	140 mm

H = Einbautiefe / recessed depth



Driver siehe Seite 195 ff. / Driver see page 195 ff.

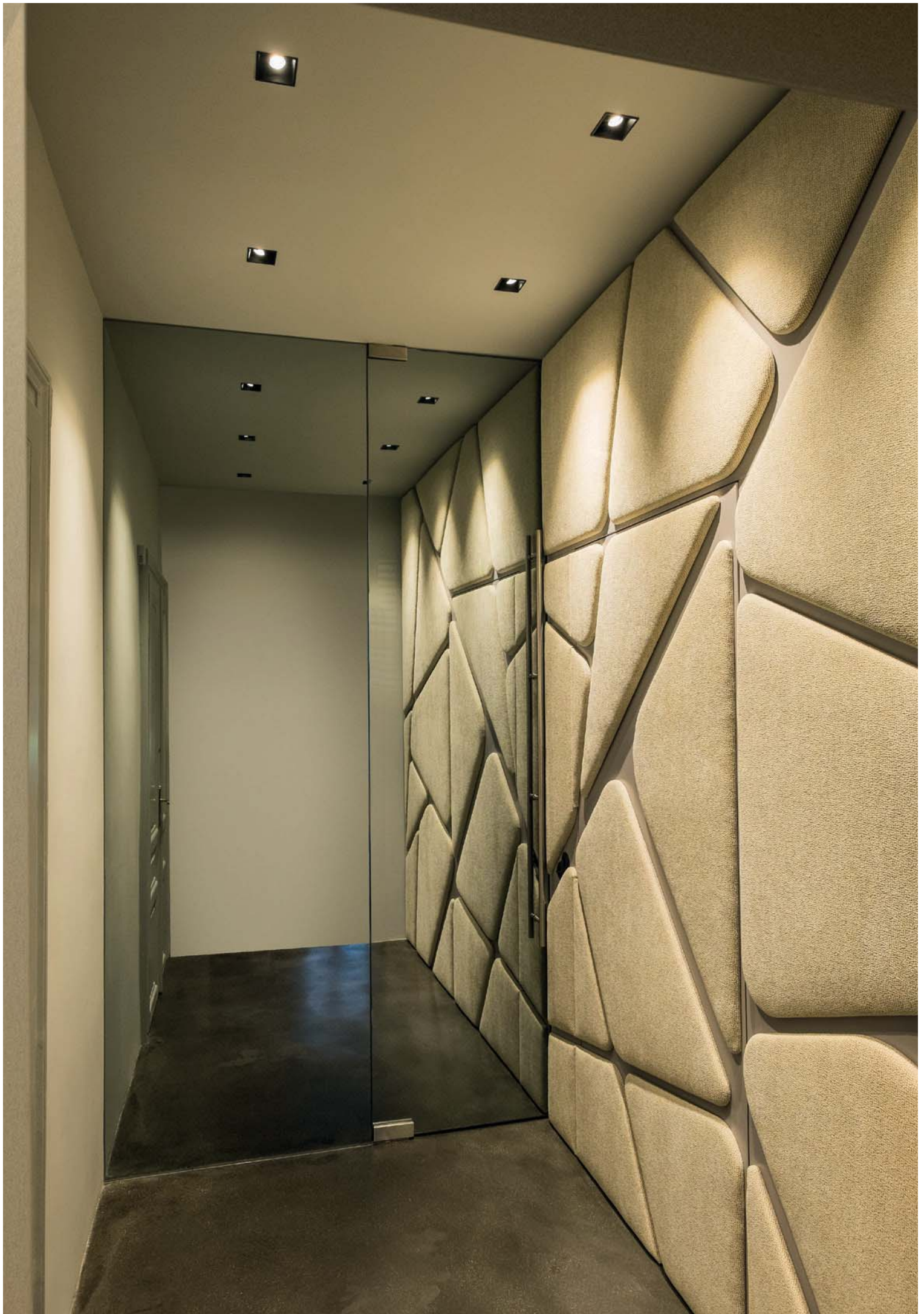

ALASKA

LED-Einbaustrahler 10 W, CRI>90, mit hochwertigem Aluminiumreflektor und Glasabdeckung, Driver bitte separat bestellen, IP54

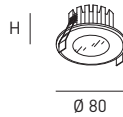

LED-recessed downlight 10 W, CRI>90, with high value aluminium reflector and glass cover, please order driver separately, IP54

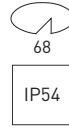
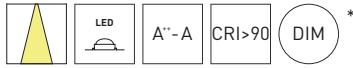

CODE	TYPE	COLOUR	LAMP	LUMEN*	POWER SUPPLY	H
D798	ALASKA	white	1x10W LED 32° □ 3000K 500mA	950 lm	excl. driver	70 mm

H = Einbautiefe / recessed depth

TWO LIGHT

LED Einbaustrahler 9,3 W, mit hochwertigem Aluminiumreflektor, tiefer gesetzter COB LED, CRI>90, und zusätzlichen SMD LEDs für indirekten Lichteffect, Driver bitte separat bestellen

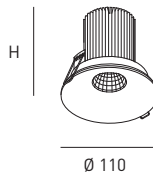

LED-recessed downlight 9,3 W with high value aluminium reflector, with recessed COB LED, CRI>90, and additional SMD LEDs for indirect lighting effect, please order driver separately

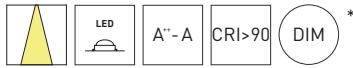

CODE	TYPE	COLOUR	LAMP	LUMEN*	POWER SUPPLY	H
D781	TWO LIGHT	white	1x9,3W LED 32° □ 3000K + 1x1,2W LED □ amber / 500mA	880 lm	excl. driver	100 mm

H = Einbautiefe / recessed depth

TWO LIGHT

LED Einbaustrahler 9,3 W, mit hochwertigem Aluminiumreflektor, tiefer gesetzter COB LED, CRI>90, und zusätzlichen SMD LEDs für indirekten Lichteffect, Driver bitte separat bestellen

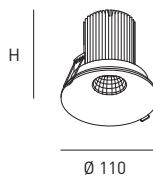

LED-recessed downlight 9,3 W with high value aluminium reflector, with recessed COB LED, CRI>90, and additional SMD LEDs for indirect lighting effect, please order driver separately

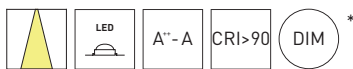

CODE	TYPE	COLOUR	LAMP	LUMEN*	POWER SUPPLY	H
D782	TWO LIGHT	white	1x9,3W LED 32° □ 3000K + 1x1,2W LED □ 3000K / 500mA	880 lm	excl. driver	100 mm

H = Einbautiefe / recessed depth

Driver siehe Seite 195 ff. / Driver see page 195 ff.



PHOENIX

LED-Einbaustrahler 13 W, CRI>90, mit Acrylglasabdeckung für zusätzliche Deckenaufhellung, Driver bitte separat bestellen, IP44

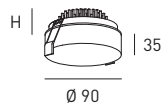

LED-recessed downlight 13 W, CRI>90, with acryl glass cover for additional ceiling brightening, please order driver separately, IP44

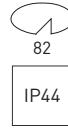
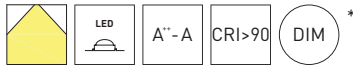

CODE	TYPE	COLOUR	LAMP	LUMEN*	POWER SUPPLY	H
D631	PHOENIX	white/opal white	1x13W LED 125° □ 2700K 350mA	1208 lm	excl. driver	45 mm

H = Einbautiefe / recessed depth

ROYAL

LED-Einbaustrahler 14,4 W, mit Linsenoptik und Acrylglasaufsatz, Driver bitte separat bestellen

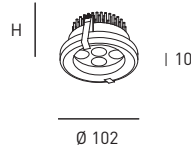

LED-recessed downlight 14,4 W, with optic lenses and acryl glass cover, please order driver separately

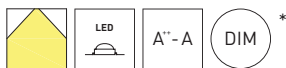

CODE	TYPE	COLOUR	LAMP	LUMEN*	POWER SUPPLY	H
D249	ROYAL	opal white	6x2,4W LED □ 3000K 500mA	820 lm	excl. driver	75 mm

H = Einbautiefe / recessed depth

Driver siehe Seite 195 ff. / Driver see page 195 ff.



IDOWN 13

LED-Einbaustrahler 13 W, mit hochwertigem Aluminiumreflektor und spezieller Glasabdeckung, Driver bitte separat bestellen, IP54

LED-recessed downlight 13 W, with high value aluminium reflector and special glass cover, please order driver separately, IP54

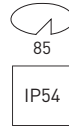
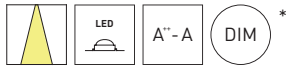
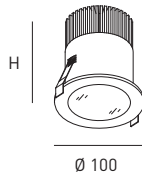

CODE	TYPE	COLOUR	LAMP	LUMEN*	POWER SUPPLY	H
D791	IDOWN 13	white	1x13W LED 30° 3000K 350mA	1360 lm	excl. driver	110 mm
15° Abstrahlwinkel auf Anfrage / 15° beam angle on request						H = Einbautiefe / recessed depth

IDOWN 26

LED-Einbaustrahler 26 W, mit hochwertigem Aluminiumreflektor und spezieller Glasabdeckung, Driver bitte separat bestellen, IP54

LED-recessed downlight 26 W, with high value aluminium reflector and special glass cover, please order driver separately, IP54

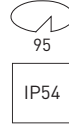
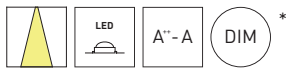
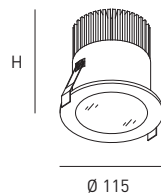

CODE	TYPE	COLOUR	LAMP	LUMEN*	POWER SUPPLY	H
D792	IDOWN 26	white	1x26W LED 30° 3000K 700mA	2540 lm	excl. driver	115 mm
15° Abstrahlwinkel auf Anfrage / 15° beam angle on request						H = Einbautiefe / recessed depth

Driver siehe Seite 195 ff. / Driver see page 195 ff.

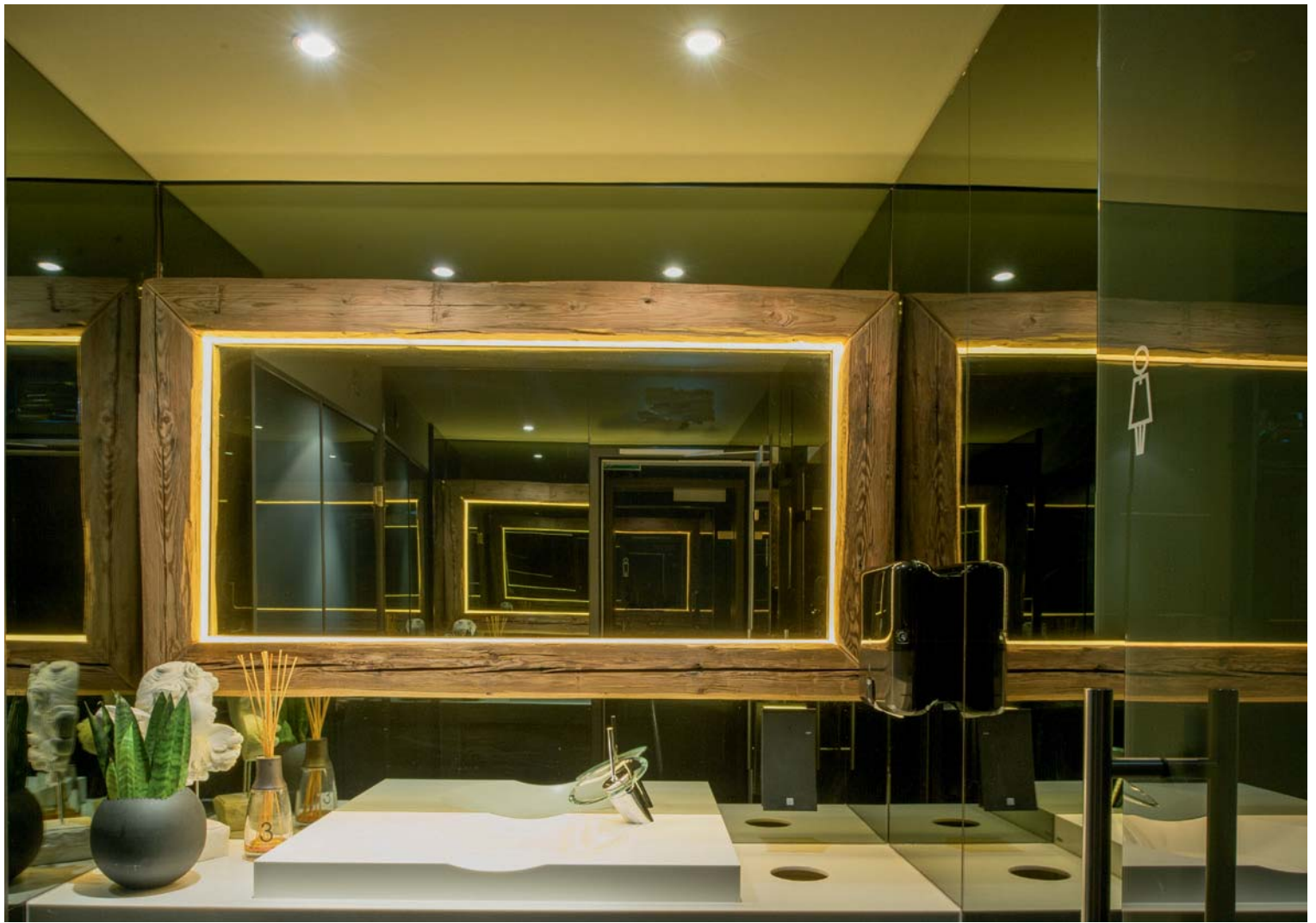

CITY XS

LED-Einbaudownlight
10,2 W, mit extra tief
gesetzten LEDs und
Linsenoptik, Driver
bitte separat bestellen

LED-recessed downlight
10,2 W, with recessed
illuminant and optical
lenses, please order
driver separately

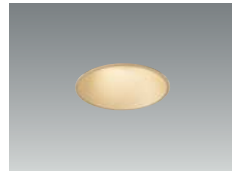
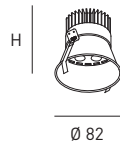
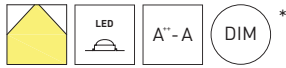

CODE	TYPE	COLOUR	LAMP	LUMEN*	POWER SUPPLY	H
D793	CITY XS	white	3x3,4W LED 36° □ 3000K 1050mA	660 lm	excl. driver	105 mm
D993	CITY XS	gold	3x3,4W LED 36° □ 3000K 1050mA	660 lm	excl. driver	105 mm

H = Einbautiefe / recessed depth

CITY S

LED-Einbaudownlight
17 W, mit extra tief
gesetzten LEDs und
Linsenoptik, Driver
bitte separat bestellen

LED-recessed downlight
17 W, with recessed
illuminant and optical
lenses, please order
driver separately

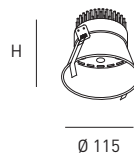
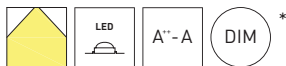

CODE	TYPE	COLOUR	LAMP	LUMEN*	POWER SUPPLY	H
D256	CITY S	white	5x3,4W LED 36° □ 3000K 1050mA	1100 lm	excl. driver	122 mm
D956	CITY S	gold	5x3,4W LED 36° □ 3000K 1050mA	1100 lm	excl. driver	122 mm

H = Einbautiefe / recessed depth

CITY

LED-Einbaudownlight
23,8 W, mit extra tief
gesetzten LEDs und
Linsenoptik, Driver
bitte separat bestellen

LED-recessed downlight
23,8 W, with recessed
illuminant and optical
lenses, please order
driver separately

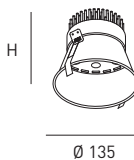
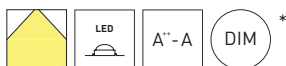

CODE	TYPE	COLOUR	LAMP	LUMEN*	POWER SUPPLY	H
D257	CITY	white	7x3,4W LED 36° □ 3000K 1050mA	1540 lm	excl. driver	132 mm
D957	CITY	gold	7x3,4W LED 36° □ 3000K 1050mA	1540 lm	excl. driver	132 mm

H = Einbautiefe / recessed depth

Driver siehe Seite 195 ff. / Driver see page 195 ff.

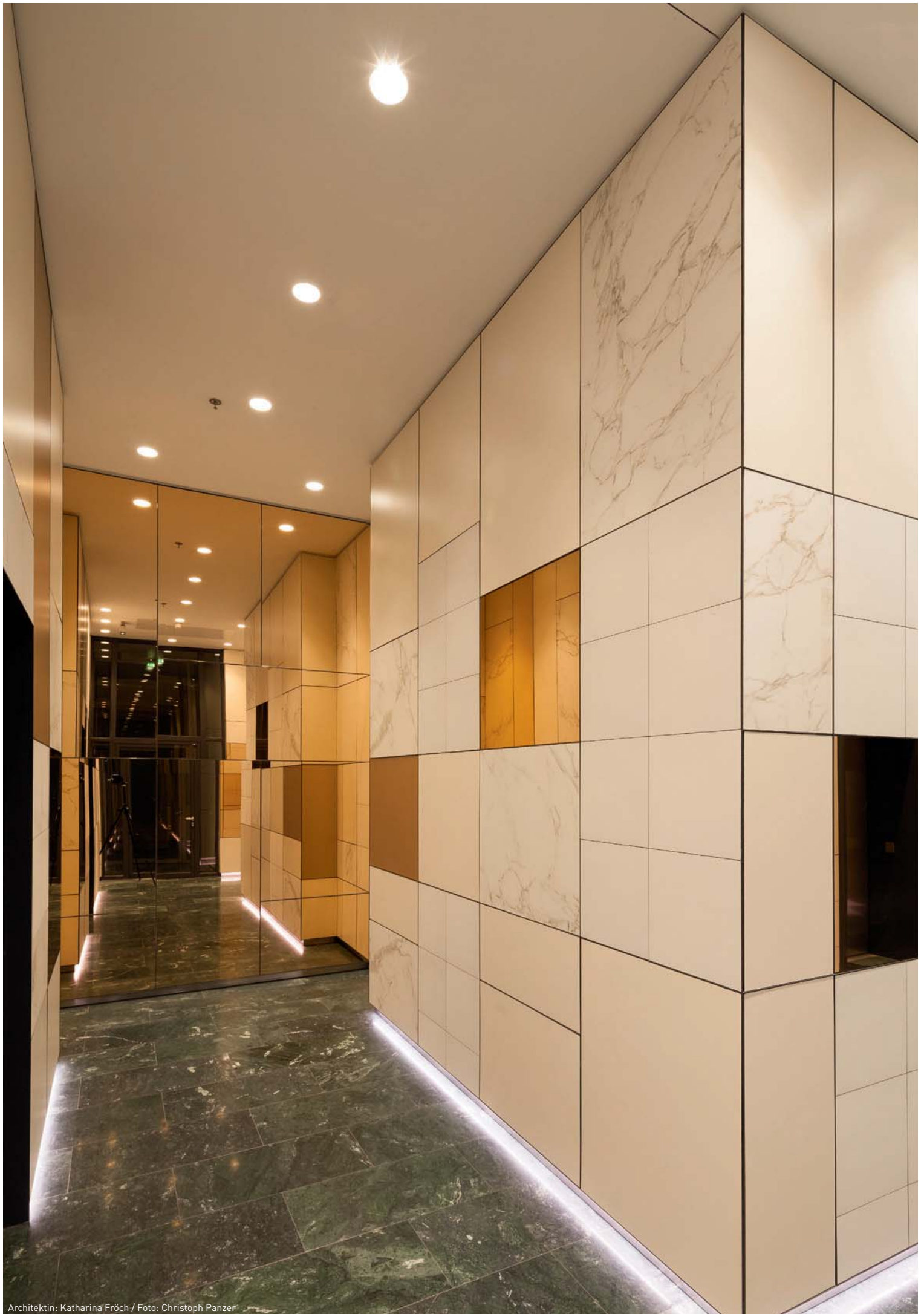

MK 90

LED-Einbaustrahler 230 V, mit 10 W AC-LED, hochwertigem Aluminiumreflektor, mit tiefer gesetzter LED, inklusive elektronischem Überspannungsschutz, IP44

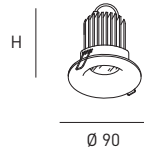

LED-recessed downlight 230 V, with 10 W AC-LED, high value aluminium reflector, with recessed LED, including surge protection, IP44

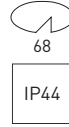
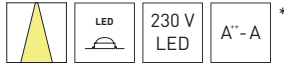

CODE	TYPE	COLOUR	LAMP	LUMEN*	POWER SUPPLY	H
D786	MK 90	white	1x10W LED 40° ■ 3000K	850 lm	230 V	110 mm

H = Einbautiefe / recessed depth

MK 110

LED-Einbaustrahler 230 V, mit 10 W AC-LED, hochwertigem Aluminiumreflektor, dreh- und schwenkbar (360°/2x30°), mit tiefer gesetzter LED, inklusive elektronischem Überspannungsschutz, IP44

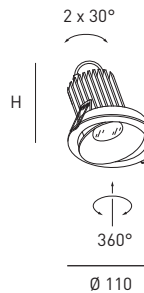

LED-recessed downlight 230 V, with 10 W AC-LED, high value aluminium reflector, adjustable (360°/2x30°), with recessed LED, including surge protection, IP44

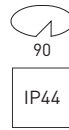
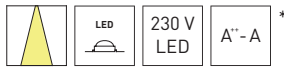

CODE	TYPE	COLOUR	LAMP	LUMEN*	POWER SUPPLY	H
D787	MK 110	white	1x10W LED 40° ■ 3000K	850 lm	230 V	110 mm

H = Einbautiefe / recessed depth

MK Q

LED-Einbaustrahler 230 V, mit 10 W AC-LED, hochwertigem Aluminiumreflektor, schwenkbar (2x30°), mit tiefer gesetzter LED, inklusive elektronischem Überspannungsschutz, IP44

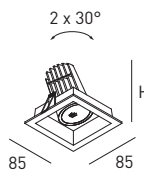

LED-recessed downlight 230 V, with 10 W AC-LED, high value aluminium reflector, adjustable (2x30°), with recessed LED, including surge protection, IP44

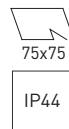

CODE	TYPE	COLOUR	LAMP	LUMEN*	POWER SUPPLY	H
D749	MK Q	white	1x10W LED 40° ■ 3000K	850 lm	230 V	120 mm

H = Einbautiefe / recessed depth



BIG

Einbaustrahler 12 V oder 230 V, schwenkbar (2 x 10°), mit tiefer gesetztem Leuchtmittel und Entblendungsring, für 12 V oder 230 V LED- und Halogen-Leuchtmittel geeignet, Transformator bitte separat bestellen

Recessed downlight 12 V or 230 V, adjustable (2 x 10°), with recessed illuminant and anti glare ring, 12 V or 230 V LED and halogen lamps are suitable, please order transformer separately

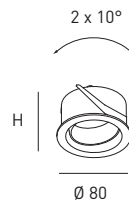

CODE	TYPE	COLOUR	LAMP	POWER SUPPLY	H
D307	BIG	white	1xGU10 LED or 1x30W halogen	230 V	115 mm
D502	BIG	black	1xGU10 LED or 1x30W halogen	230 V	115 mm
D306	BIG	grey	1xGU10 LED or 1x30W halogen	230 V	115 mm
D407	BIG	white	1xGU5,3 LED or 1x35W IRC halogen	excl. transformer	110 mm
D504	BIG	black	1xGU5,3 LED or 1x35W IRC halogen	excl. transformer	110 mm
D406	BIG	grey	1xGU5,3 LED or 1x35W IRC halogen	excl. transformer	110 mm

H = Einbautiefe / recessed depth

CONE

Einbaustrahler 12 V oder 230 V, schwenkbar (2 x 30°), mit abnehmbarem Entblendungskonus, für 12 V oder 230 V LED- und Halogen-Leuchtmittel geeignet, Transformator bitte separat bestellen

Recessed downlight 12 V or 230 V, adjustable (2 x 30°), with removable anti glare cone, 12 V or 230 V LED and halogen lamps are suitable, please order transformer separately

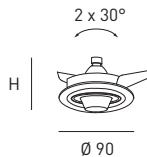

CODE	TYPE	COLOUR	LAMP	POWER SUPPLY	H
D940	CONE	white	1xGU10 LED or 1x30W halogen**	230 V	100 mm
D942	CONE	black	1xGU10 LED or 1x30W halogen**	230 V	100 mm
D941	CONE	grey	1xGU10 LED or 1x30W halogen**	230 V	100 mm
D440	CONE	white	1xGU5,3 LED or 1x35W IRC halogen	excl. transformer	90 mm
D442	CONE	black	1xGU5,3 LED or 1x35W IRC halogen	excl. transformer	90 mm
D441	CONE	grey	1xGU5,3 LED or 1x35W IRC halogen	excl. transformer	90 mm

H = Einbautiefe / recessed depth



Transformatoren siehe Seite 194 / Transformer see page 194

** 12 V Halogen mit Entblendungskonus max. 20 W / **12 V halogen with anti glare cone maximum 20 W

* Technische Informationen siehe Seite 189 / Lumenangaben sind Nominalwerte - * Technical information see page 189 / Lumen data are nominal data



Architekt: BWM Architekten



Architekt: GDC Innenarchitektur / Foto: Hannes Buchinger

DONUT

Einbaustrahler 230 V, mit tiefer gesetztem Leuchtmittel, für LED- und Halogen-Leuchtmittel geeignet

Recessed downlight 230 V, with recessed illuminant, LED and halogen lamps are suitable

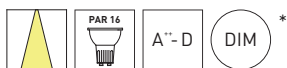
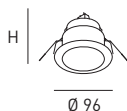

CODE	TYPE	COLOUR	LAMP	POWER SUPPLY	H
D319	DONUT	white	1xGU10 LED or 1x30W halogen	230 V	125 mm

H = Einbautiefe / recessed depth

SONO

Einbaustrahler 12 V oder 230 V, schwenkbar (2x 15°), mit tiefer gesetztem Leuchtmittel, für 12 V oder 230 V LED- und Halogen-Leuchtmittel geeignet, Transformator bitte separat bestellen

Recessed downlight 12 V or 230 V, adjustable (2x 15°), with recessed illuminant, 12 V or 230 V LED and halogen lamps are suitable, please order transformer separately

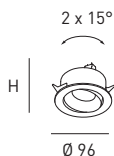

CODE	TYPE	COLOUR	LAMP	POWER SUPPLY	H
D323	SONO	white	1xGU10 LED or 1x30W halogen	230 V	100 mm
D423	SONO	white	1xGU5,3 LED or 1x35W IRC halogen	excl. transformer	90 mm

H = Einbautiefe / recessed depth

Transformatoren siehe Seite 194 / Transformer see page 194



CPX 115

LED-Einbaustrahler 18 W, CRI>90, mit tiefer gesetzter LED und hochwertiger Linsenoptik, Entblendungsring wahlweise schwarz oder chrom, dreh- und schwenkbar (350°/30°), Driver bitte separat bestellen

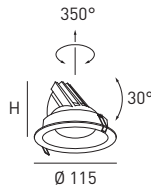

LED-recessed downlight 18 W, CRI>90, with recessed LED and high efficient optic lense, anti glare ring optionally black or chrome, adjustable (350°/30°), please order driver separately

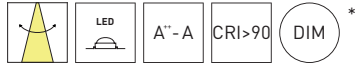

CODE	TYPE	COLOUR	LAMP	LUMEN*	POWER SUPPLY	H
D526	CPX 115	white/black	1x18W LED 30° □ 3000K 500mA	2190 lm	excl. driver	105 mm
D527	CPX 115	white/chrome	1x18W LED 30° □ 3000K 500mA	2190 lm	excl. driver	105 mm
D524	CPX 115	black/black	1x18W LED 30° □ 3000K 500mA	2190 lm	excl. driver	105 mm
D525	CPX 115	black/chrome	1x18W LED 30° □ 3000K 500mA	2190 lm	excl. driver	105 mm

2700K LED auf Anfrage / 2700K LED on request

H = Einbautiefe / recessed depth

Driver siehe Seite 195 ff. / Driver see page 195 ff.

* Technische Informationen siehe Seite 189 / Lumenangaben sind Nominalwerte
* Technical information see page 189 / Lumen data are nominal data



CPX 170

LED-Einbaustrahler 33 W, CRI>90, mit tiefer gesetzter LED und hochwertiger Linsenoptik, Entblendungsring wahlweise schwarz oder chrom, dreh- und schwenkbar (350°/30°), Driver bitte separat bestellen

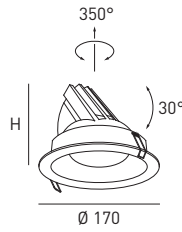

LED-recessed downlight 33 W, CRI>90, with recessed LED and high efficient optic lense, anti glare ring optionally black or chrome, adjustable (350°/30°), please order driver separately

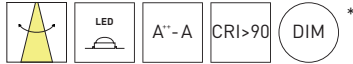

CODE	TYPE	COLOUR	LAMP	LUMEN*	POWER SUPPLY	H
D530	CPX 170	white/black	1x33W LED 30° □ 3000K 900mA	4200 lm	excl. driver	145 mm
D531	CPX 170	white/chrome	1x33W LED 30° □ 3000K 900mA	4200 lm	excl. driver	145 mm
D528	CPX 170	black/black	1x33W LED 30° □ 3000K 900mA	4200 lm	excl. driver	145 mm
D529	CPX 170	black/chrome	1x33W LED 30° □ 3000K 900mA	4200 lm	excl. driver	145 mm

2700K LED auf Anfrage / 2700K LED on request

H = Einbautiefe / recessed depth

Driver siehe Seite 195 ff. / Driver see page 195 ff.

* Technische Informationen siehe Seite 189 / Lumenangaben sind Nominalwerte
* Technical information see page 189 / Lumen data are nominal data

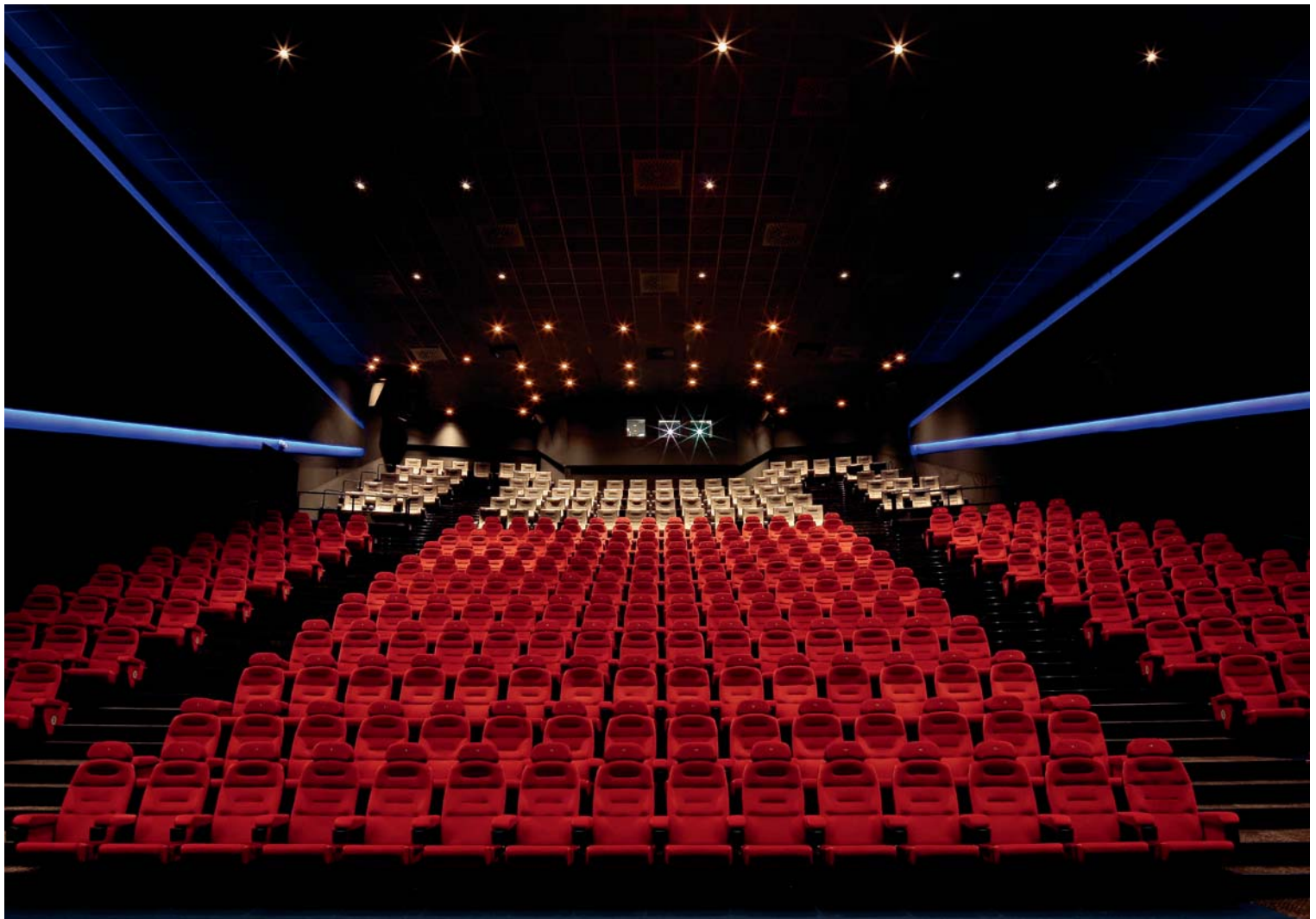
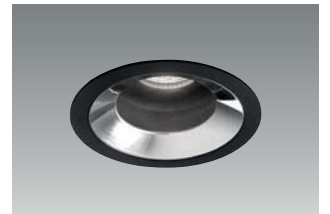

CENTRO

LED-Einbaudownlight
13 W, CRI>90, mit hoch-
wertigem Aluminium-
Darklightreflektor, Driver
bitte separat bestellen

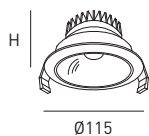

LED-recessed downlight
13 W, CRI>90, with high
value aluminium darklight
reflector, please order
driver separately



CODE	TYPE	COLOUR	LAMP	LUMEN*	POWER SUPPLY	H
D212	CENTRO	white	1x13W LED 75° □ 3000K 350mA	1295 lm	excl. driver	85 mm

H = Einbautiefe / recessed depth

CENTRO XL

LED-Einbaudownlight
27 W, CRI>90, mit hoch-
wertigem Aluminium-
Darklightreflektor, Driver
bitte separat bestellen

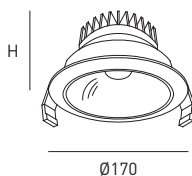

LED-recessed downlight
27 W, CRI>90, with high
value aluminium darklight
reflector, please order
driver separately

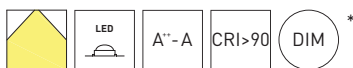

CODE	TYPE	COLOUR	LAMP	LUMEN*	POWER SUPPLY	H
D258	CENTRO XL	white	1x27W LED 80° □ 3000K 700mA	2465 lm	excl. driver	130 mm

H = Einbautiefe / recessed depth

Driver siehe Seite 195 ff. / Driver see page 195 ff.



STRATO 190

LED-Einbaudownlight 16 W, inklusive Driver 230 V mit hochwertigem Aluminiumreflektor und tiefer gesetzter Fresnellinse, IP44

LED-recessed downlight 16 W, including driver 230 V with high value aluminium reflector and recessed Fresnel lens, IP44

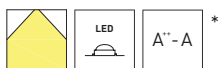
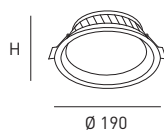

CODE	TYPE	COLOUR	LAMP	LUMEN*	POWER SUPPLY	H
D208	STRATO 190	white	16W LED ■ 3000K	1640 lm	incl. driver	85 mm

H = Einbautiefe / recessed depth

STRATO 230

LED-Einbaudownlight 21 W, inklusive Driver 230 V mit hochwertigem Aluminiumreflektor und tiefer gesetzter Fresnellinse, IP44

LED-recessed downlight 21 W, including driver 230 V with high value aluminium reflector and recessed Fresnel lens, IP44

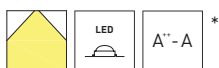
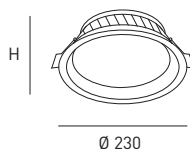

CODE	TYPE	COLOUR	LAMP	LUMEN*	POWER SUPPLY	H
D210	STRATO 230	white	21W LED ■ 3000K	2160 lm	incl. driver	95 mm

H = Einbautiefe / recessed depth



VARO

LED-Einbaustrahler 34 W, mit hochwertigem Aluminiumreflektor, aus massivem Aluminium, schwenkbar (2x20°), Driver bitte separat bestellen

LED-recessed downlight 34 W, with high value aluminium reflector, made of aluminium, adjustable (2x20°), please order driver separately

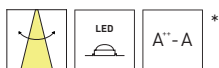
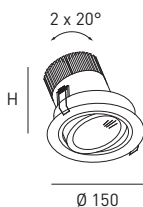

CODE	TYPE	COLOUR	LAMP	LUMEN*	POWER SUPPLY	H
D751	VARO	white	1x34W LED 30° ■ 3000K 900mA	3250 lm	excl. driver	160 mm

H = Einbautiefe / recessed depth

Driver siehe Seite 195 ff. / Driver see page 195 ff.



CLIVE CHRISTIAN

GUERLAIN

ANNICK GOUTAL

ANNICK GOUTAL

FRENCH ROSS

RINGO

LED-Deckenleuchte 14 W mit eingebautem Driver 230 V, CRI>90, dimmbar mit Phasenanschnitt-/Phasenabschnittdimmer, Gehäuse aus massivem Aluminium mit Acrylglasabdeckung, für den Innen- und Außenbereich verwendbar, IP54

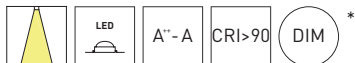
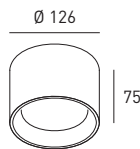

CODE	TYPE	COLOUR	LAMP	LUMEN*	POWER SUPPLY
D829	RINGO	white	14W LED 3000K	1350 lm	incl. driver phase dim
D809	RINGO	black	14W LED 3000K	1350 lm	incl. driver phase dim

CL 15

Deckenstrahler 230 V, Gehäuse aus Aluminium, für LED-Leuchtmittel geeignet, für den Innen- und Außenbereich geeignet, IP44

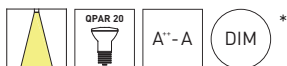
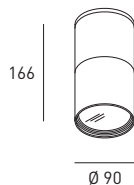

CODE	TYPE	COLOUR	LAMP	POWER SUPPLY
D352	CL 15	white	1xE27 LED	230 V
D422	CL 15	black	1xE27 LED	230 V
D351	CL 15	grey	1xE27 LED	230 V



Griner

Griner

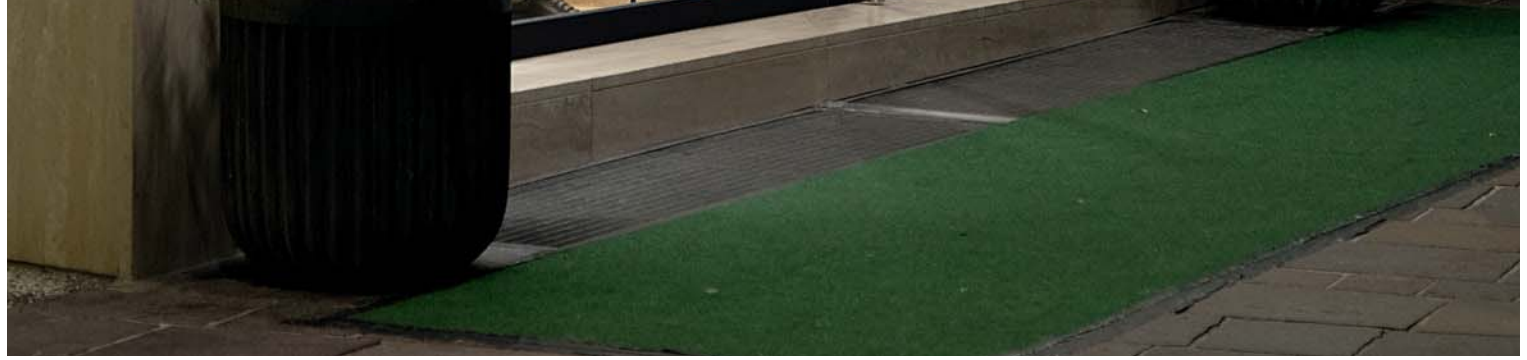

DIVA

LED-Wand und Deckenleuchte 230 V, mit 18 W AC-LED, Gehäuse aus Aluminiumdruckguss, mit Acrylglasabdeckung, für den Innen- und Außenbereich verwendbar, IP54

LED-wall and ceiling luminaire 230 V, with 18 W AC-LED, housing made of die-cast aluminium, with acrylic glass cover, to be used in indoor and outdoor areas, IP54

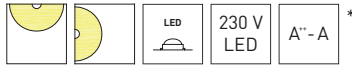
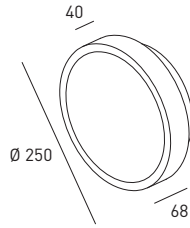

CODE	TYPE	COLOUR	LAMP	LUMEN*	POWER SUPPLY
D838	DIVA	white	18W LED □ 3000K	1180 lm	230 V

DIVA Q

LED-Wand und Deckenleuchte 230 V, mit 18 W AC-LED, Gehäuse aus Aluminiumdruckguss, mit Acrylglasabdeckung, für den Innen- und Außenbereich verwendbar, IP54

LED-wall and ceiling luminaire 230 V, with 18 W AC-LED, housing made of die-cast aluminium, with acrylic glass cover, to be used in indoor and outdoor areas, IP54

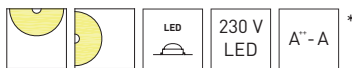
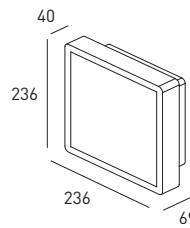

CODE	TYPE	COLOUR	LAMP	LUMEN*	POWER SUPPLY
D839	DIVA Q	white	18W LED □ 3000K	1180 lm	230 V

LIBERTY

LED-Wand- und Deckenleuchte
 11 W, mit eingebautem Driver
 230 V, CRI>90, dimmbar mit
 Phasenanschnitt-/Phasen-
 abschnittdimmer, Gehäuse
 aus massivem Aluminium,
 für Indirektbeleuchtung, zwei
 unterschiedliche Bauhöhen
 ermöglichen eine überlappende
 Montage, für den Innen- und
 Außenbereich verwendbar, IP54

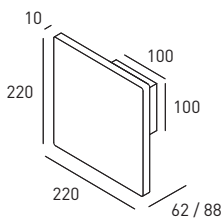

H: 62 LIBERTY
 H: 88 LIBERTY plus

LED-wall and ceiling luminaire
 11 W, with built-in driver 230
 V, CRI>90, leading edge/trail-
 ing edge dimmable, housing
 made of aluminium, for indirect
 lighting, two different sizes
 allow overlapping mounting, to
 be used in indoor and outdoor
 areas, IP54

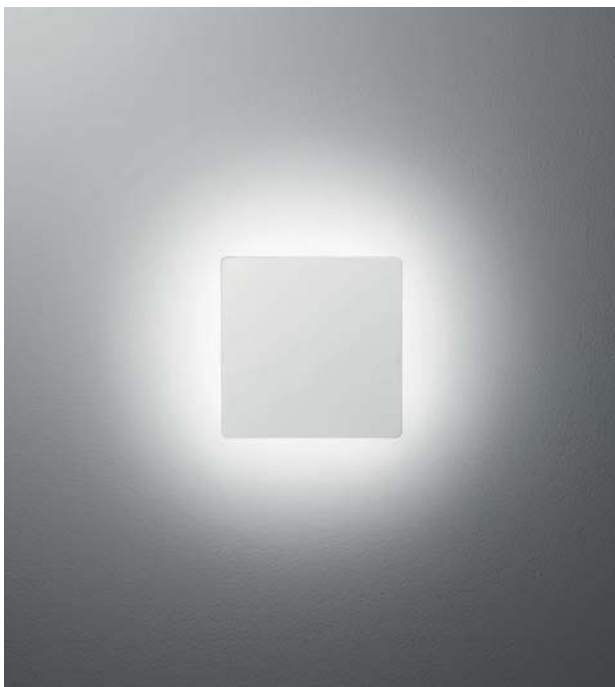
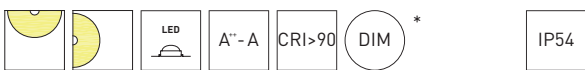

CODE	TYPE	COLOUR	LAMP	LUMEN*	POWER SUPPLY	H
D840	LIBERTY	white	11W LED 3000K	1075 lm	incl. driver phase dim	62 mm
D844	LIBERTY plus	white	11W LED 3000K	1075 lm	incl. driver phase dim	88 mm

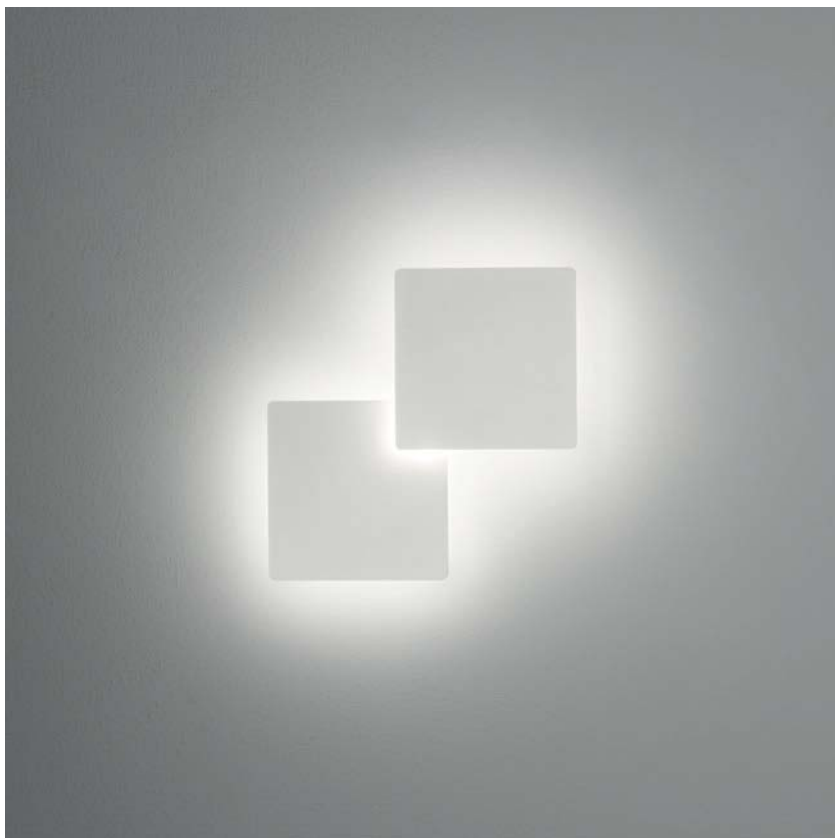
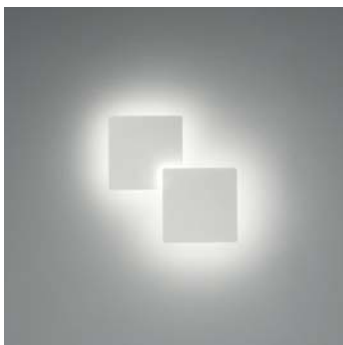

Montagebeispiel: 1xLIBERTY und 1xLIBERTY plus / Mounting example: 1xLIBERTY and 1xLIBERTY plus

TUBO

LED-Wandleuchte 230 V, mit 2x4 W AC-LED, dimmbar mit Phasenanschnittdimmer, Gehäuse aus massivem Aluminium, für Direkt- und Indirektbeleuchtung, für den Innen- und Außenbereich verwendbar, IP54

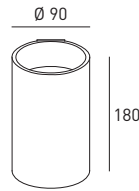

LED-wall luminaire 230 V, with 2x4 W AC-LED, leading edge dimmable, housing made of aluminium, for direct and indirect lighting, to be used in indoor and outdoor areas, IP54



IP54

CODE	TYPE	COLOUR	LAMP	LUMEN*	POWER SUPPLY
D841	TUBO	white	2x4W LED □ 3000K	2x370 lm	230 V phase dim

DIEGO

LED-Wandleuchte 2x4 W mit eingebautem Driver 230 V, CRI>90, Gehäuse aus massivem Aluminium, für Direkt- und Indirektbeleuchtung, für den Innen- und Außenbereich verwendbar, IP54

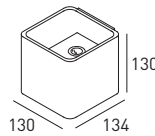

LED-wall luminaire 2x4 W with built-in driver 230 V, CRI>90, housing made of aluminium, for direct and indirect lighting, to be used in indoor and outdoor areas, IP54

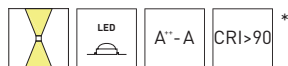

IP54

CODE	TYPE	COLOUR	LAMP	LUMEN*	POWER SUPPLY
D842	DIEGO	white	2x4W LED □ 3000K	2x435 lm	incl. driver
D808	DIEGO	black	2x4W LED □ 3000K	2x435 lm	incl. driver

MIAMI

LED-Wandleuchte 7 W mit eingebautem Driver 230 V, Gehäuse aus stranggepresstem Aluminium, dimmbar mit Phasenanschnitt-/Phasenabschnittdimmer, für Direkt- und Indirektbeleuchtung, für den Innen- und Außenbereich verwendbar, IP54

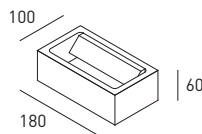

LED-wall luminaire 7 W with built-in driver 230 V, housing made of extruded aluminium, leading edge/trailing edge dimmable, for direct and indirect lighting, to be used in indoor and outdoor areas, IP54

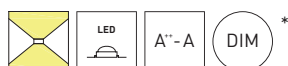

IP54

CODE	TYPE	COLOUR	LAMP	LUMEN*	POWER SUPPLY
D204	MIAMI	white	7W LED □ 3000K	695 lm	incl. driver phase dim
D608	MIAMI	black	7W LED □ 3000K	695 lm	incl. driver phase dim



Architekt: OPW / Foto: Atelier Wolf

SECRET

LED-Wandleuchte 2x3 W, CRI>90, mit eingebautem Driver 230 V, Gehäuse aus stranggepresstem Aluminium, dimmbar mit Phasenanschnitt-/Phasenabschnitt-dimmer, für Direkt- und Indirektbeleuchtung, für den Innen- und Außenbereich verwendbar, IP54

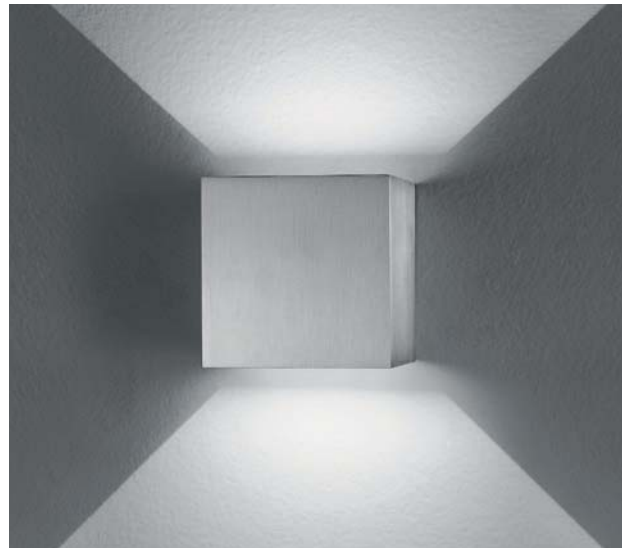
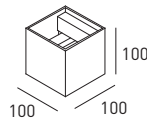

LED-wall luminaire 2x3 W, CRI>90, with built-in driver 230 V, housing made of extruded aluminium, leading edge/trailing edge dimmable, for direct and indirect lighting, to be used in indoor and outdoor areas, IP54



CODE	TYPE	COLOUR	LAMP	LUMEN*	POWER SUPPLY
D247	SECRET	white	2x3W LED □ 3000K	2x260 lm	incl. driver phase dim
D939	SECRET	black	2x3W LED □ 3000K	2x260 lm	incl. driver phase dim
D246	SECRET	grey	2x3W LED □ 3000K	2x260 lm	incl. driver phase dim
D239	SECRET	alu	2x3W LED □ 3000K	2x260 lm	incl. driver phase dim

SECRET UP

LED-Wandleuchte 1x3 W, CRI>90, mit eingebautem Driver 230 V, Gehäuse aus stranggepresstem Aluminium, für Direktbeleuchtung, für den Innen- und Außenbereich verwendbar, IP54

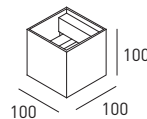

LED-wall luminaire 1x3 W, CRI>90, with built-in driver 230 V, housing made of extruded aluminium, for direct lighting, to be used in indoor and outdoor areas, IP54

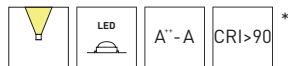

CODE	TYPE	COLOUR	LAMP	LUMEN*	POWER SUPPLY
D949	SECRET UP	white	1x3W LED □ 3000K	260 lm	incl. driver
D938	SECRET UP	black	1x3W LED □ 3000K	260 lm	incl. driver
D946	SECRET UP	grey	1x3W LED □ 3000K	260 lm	incl. driver

SECRET DOWN

LED-Wandleuchte 1x3 W, CRI>90, mit eingebautem Driver 230 V, Gehäuse aus stranggepresstem Aluminium, für Direktbeleuchtung, für den Innen- und Außenbereich verwendbar, IP54

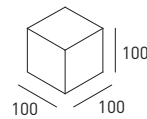

LED-wall luminaire 1x3 W, CRI>90, with built-in driver 230 V, housing made of extruded aluminium, for direct lighting, to be used in indoor and outdoor areas, IP54

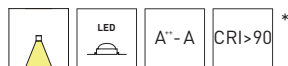

CODE	TYPE	COLOUR	LAMP	LUMEN*	POWER SUPPLY
D201	SECRET DOWN	white	1x3W LED □ 3000K	260 lm	incl. driver
D262	SECRET DOWN	black	1x3W LED □ 3000K	260 lm	incl. driver
D200	SECRET DOWN	grey	1x3W LED □ 3000K	260 lm	incl. driver

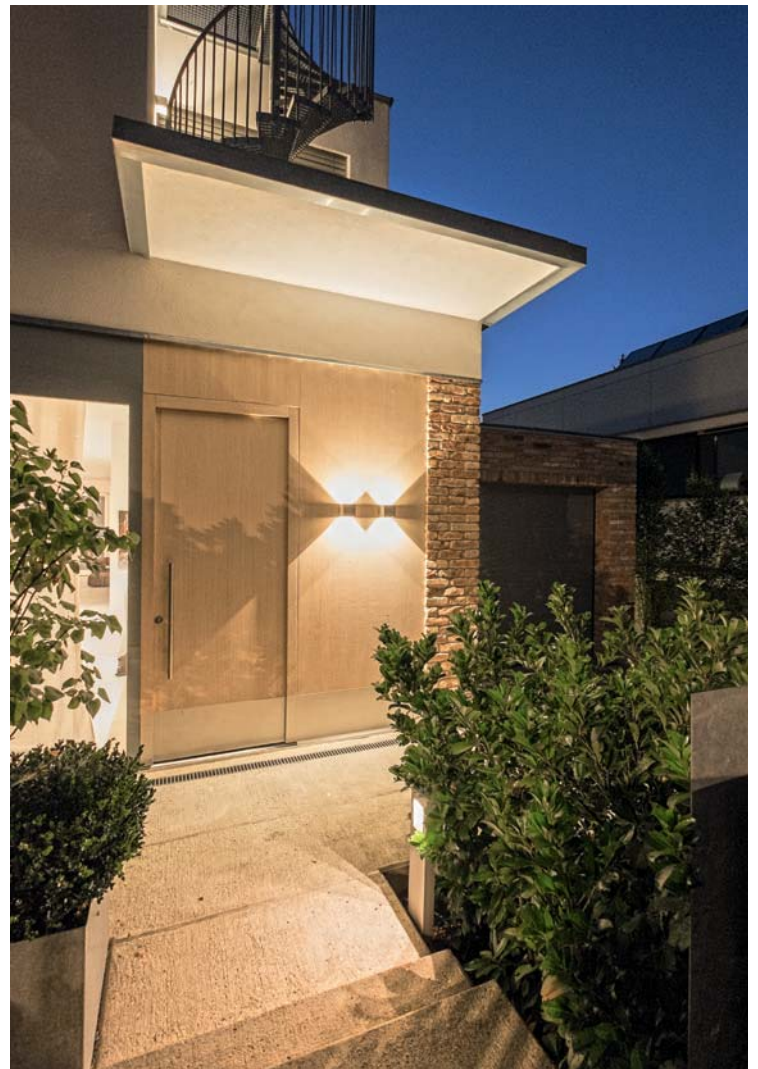
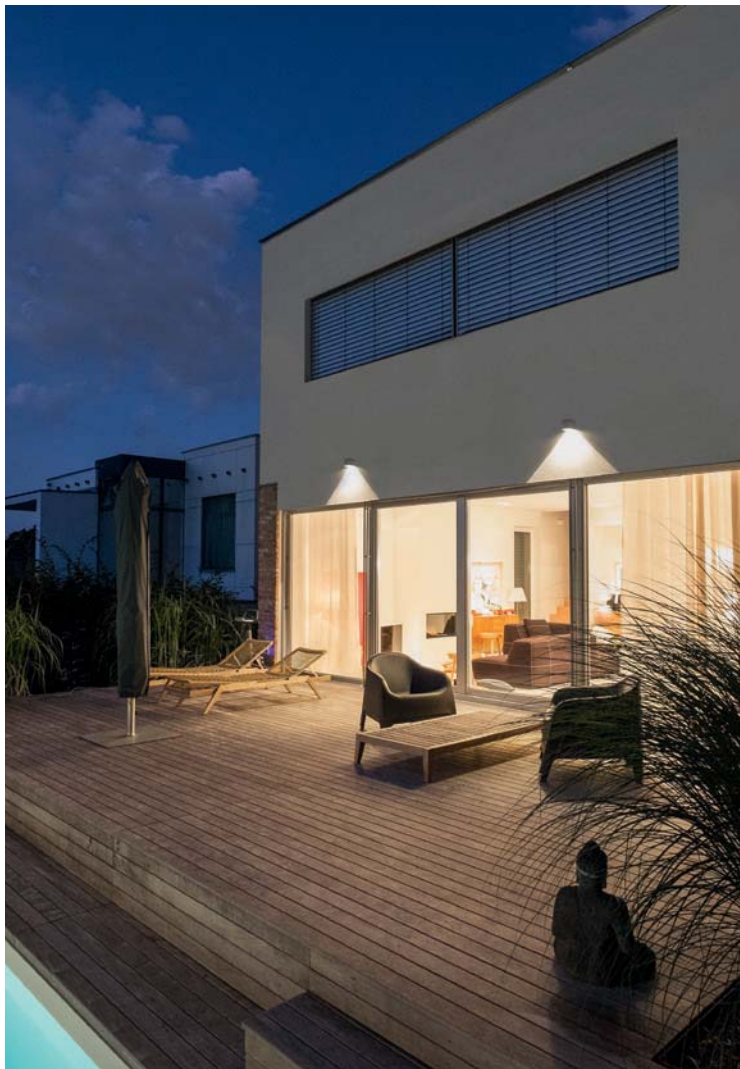

RIO

LED-Wandleuchte 2 x 1 W, mit eingebautem Driver 230 V, Gehäuse aus massivem Aluminium natur gebürstet, für Direkt- und Indirektbeleuchtung, für den Innen- und Außenbereich verwendbar, IP54

LED-wall luminaire 2 x 1 W, with built-in driver 230 V, housing made of natural brushed aluminium, for direct and indirect lighting, to be used in indoor and outdoor areas, IP54

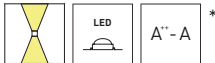
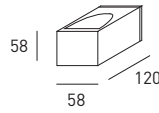

CODE	TYPE	COLOUR	LAMP	LUMEN*	POWER SUPPLY
D244	RIO	alu	2x1W LED □ 3000K	2x160 lm	incl. driver

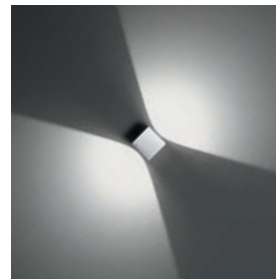



VIGO

LED-Wandleuchte 4 W mit eingebautem Driver 230 V, Gehäuse aus massivem Aluminium, für den Innen- und Außenbereich verwendbar, IP54

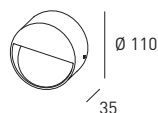

LED-wall luminaire 4 W with built-in driver 230 V, housing made of aluminium, to be used in indoor and outdoor areas, IP54

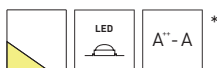

CODE	TYPE	COLOUR	LAMP	LUMEN*	POWER SUPPLY
D913	VIGO	white	4W LED □ 3000K	485 lm	incl. driver
D914	VIGO	black	4W LED □ 3000K	485 lm	incl. driver

VIGO Q

LED-Wandleuchte 4 W mit eingebautem Driver 230 V, Gehäuse aus massivem Aluminium, für den Innen- und Außenbereich verwendbar, IP54

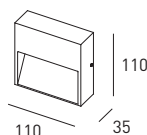

LED-wall luminaire 4 W with built-in driver 230 V, housing made of aluminium, to be used in indoor and outdoor areas, IP54

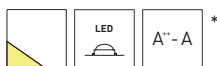

CODE	TYPE	COLOUR	LAMP	LUMEN*	POWER SUPPLY
D943	VIGO Q	white	4W LED □ 3000K	485 lm	incl. driver
D944	VIGO Q	black	4W LED □ 3000K	485 lm	incl. driver

FLATBOX

LED-Wandleuchte 4 W, CRI>90, mit eingebautem Driver 230 V, Gehäuse aus massivem Aluminium, mit einseitigem Lichtaustritt, für den Innen- und Außenbereich verwendbar, IP54

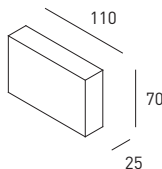

LED-wall luminaire 4 W, CRI>90, with built-in driver 230 V, housing made of aluminium, with one-sided light emission, to be used in indoor and outdoor areas, IP54

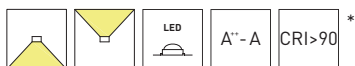

CODE	TYPE	COLOUR	LAMP	LUMEN*	POWER SUPPLY
D206	FLATBOX	white	4W LED □ 3000K	420 lm	incl. driver
D606	FLATBOX	black	4W LED □ 3000K	420 lm	incl. driver

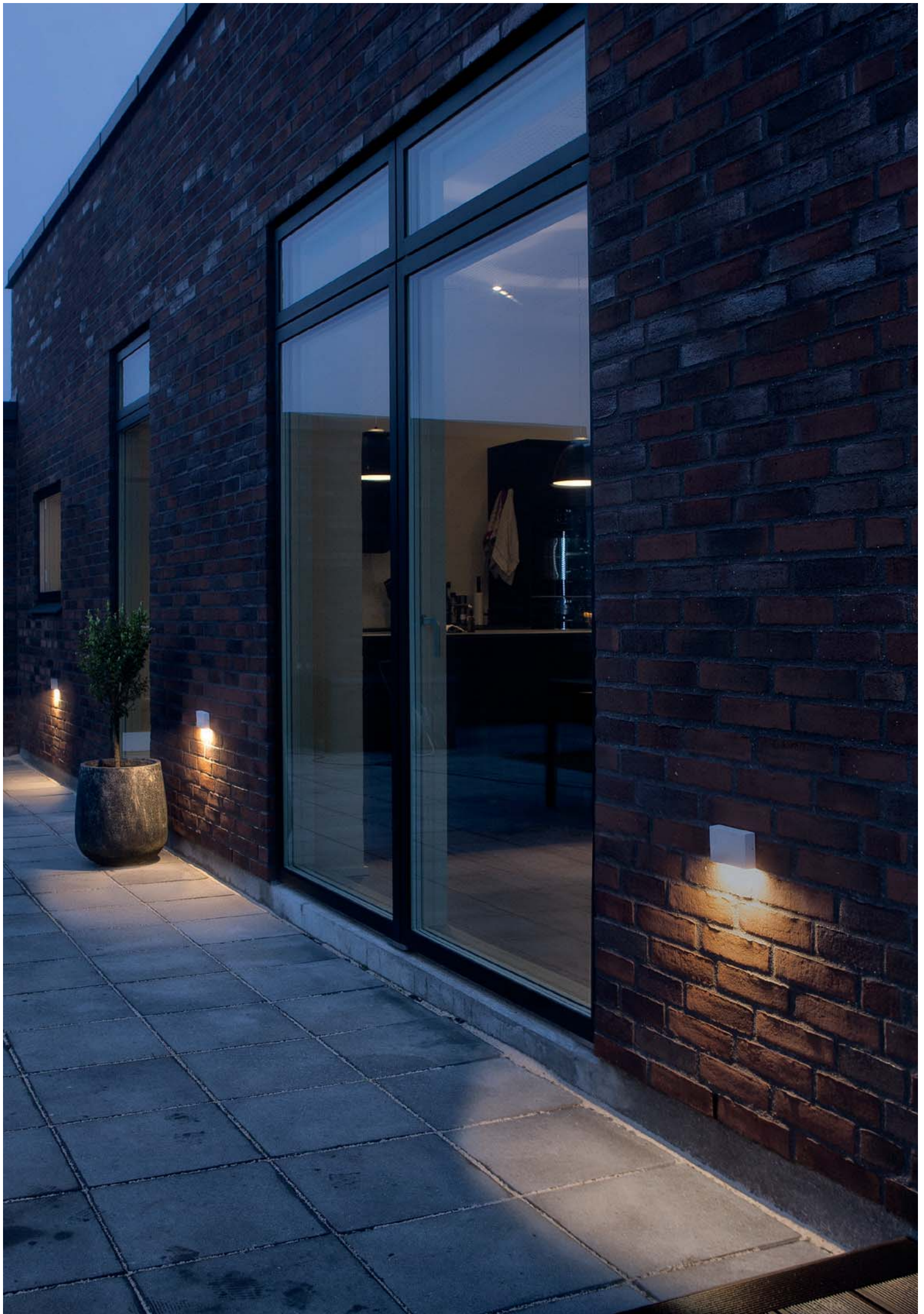

SILENCE

LED-Wandleuchte 3 W mit eingebautem Driver 230 V, Gehäuse aus massivem Aluminium, mit einseitigem Lichtaustritt, für den Innen- und Außenbereich verwendbar, IP54

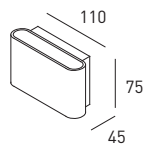

LED-wall luminaire 3 W with built-in driver 230 V, housing made of aluminium, with one-sided light emission, to be used in indoor and outdoor areas, IP54

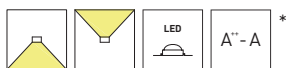

IP54

CODE	TYPE	COLOUR	LAMP	LUMEN*	POWER SUPPLY
D220	SILENCE	white	3W LED □ 3000K	270 lm	incl. driver
D620	SILENCE	black	3W LED □ 3000K	270 lm	incl. driver
D221	SILENCE	grey	3W LED □ 3000K	270 lm	incl. driver

SAXO ON

LED-Wandleuchte 2 W, Gehäuse aus massivem Aluminium, inklusive Driver, für den Innen- und Außenbereich verwendbar, IP54

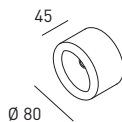

LED-wall luminaire 2 W, housing made of aluminium, including driver, to be used in indoor and outdoor areas, IP54

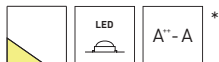

IP54

CODE	TYPE	COLOUR	LAMP	LUMEN*	POWER SUPPLY
D203	SAXO ON	white	1x2W LED □ 3000K	170 lm	incl. driver

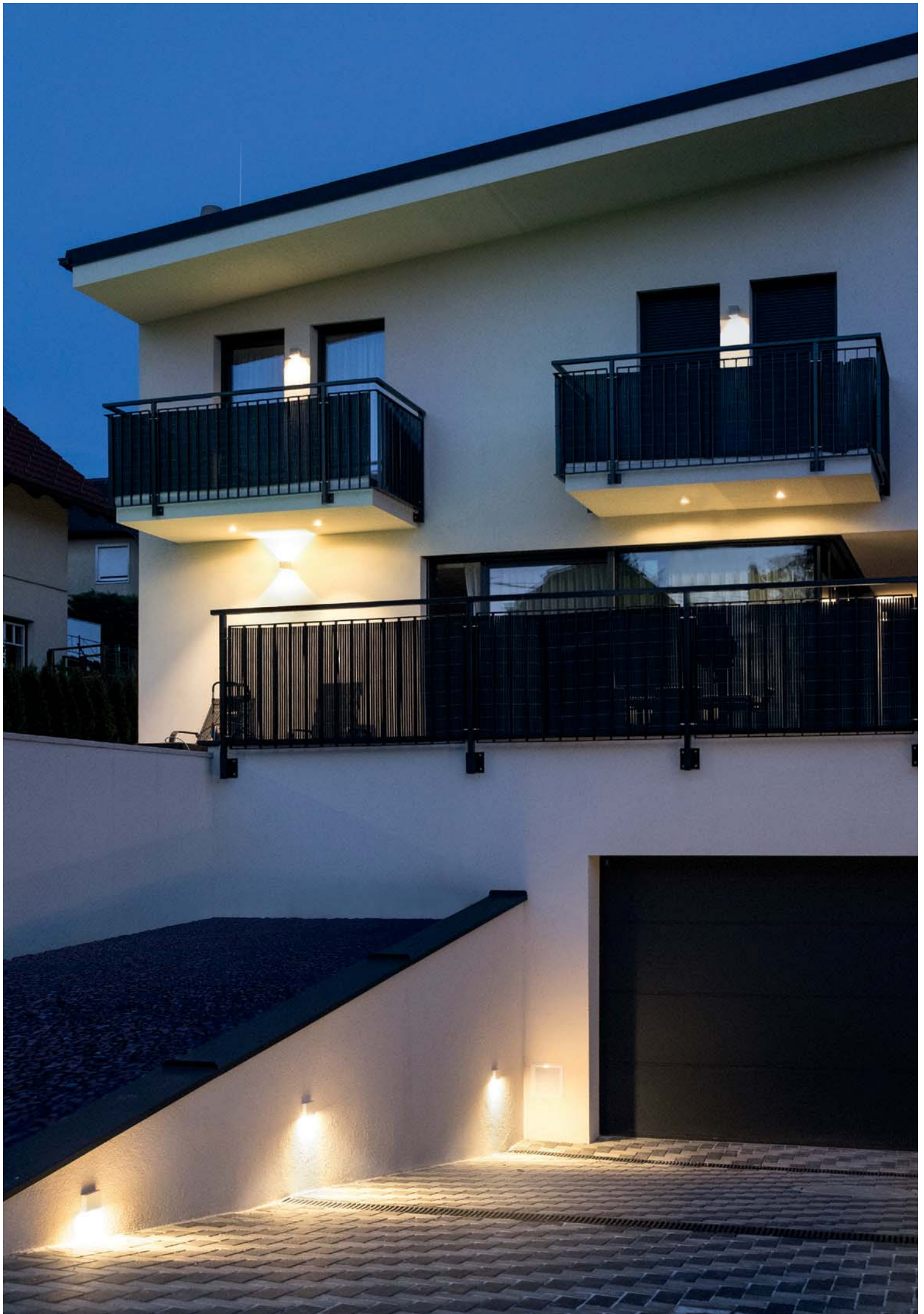

STANLEY 1

LED-Pollerleuchte 7 W,
Gehäuse aus Aluminium-
guss, mit eingebautem Dri-
ver 230 V, mit einseitigem
Lichtaustritt, IP54

LED-bollard luminaire 7 W
housing made of die-cast
aluminium, with built-in
driver 230 V, with one-sided
light emission, IP54

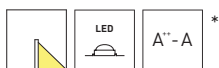
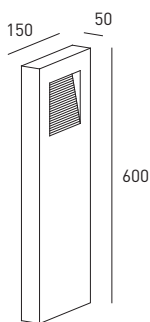

CODE	TYPE	COLOUR	LAMP	LUMEN*	POWER SUPPLY
D814	STANLEY 1	grey	1x7W LED □ 3000K	760 lm	incl. driver

STANLEY 2

LED-Pollerleuchte 7 W,
Gehäuse aus Aluminium-
guss, mit eingebautem Dri-
ver 230 V, mit zweiseitigem
Lichtaustritt, IP54

LED-bollard luminaire 7 W
housing made of die-cast
aluminium, with built-in
driver 230 V, with two-sided
light emission, IP54

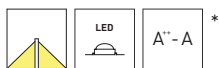
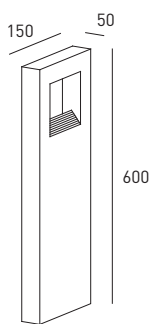

CODE	TYPE	COLOUR	LAMP	LUMEN*	POWER SUPPLY
D813	STANLEY 2	grey	1x7W LED □ 3000K	760 lm	incl. driver

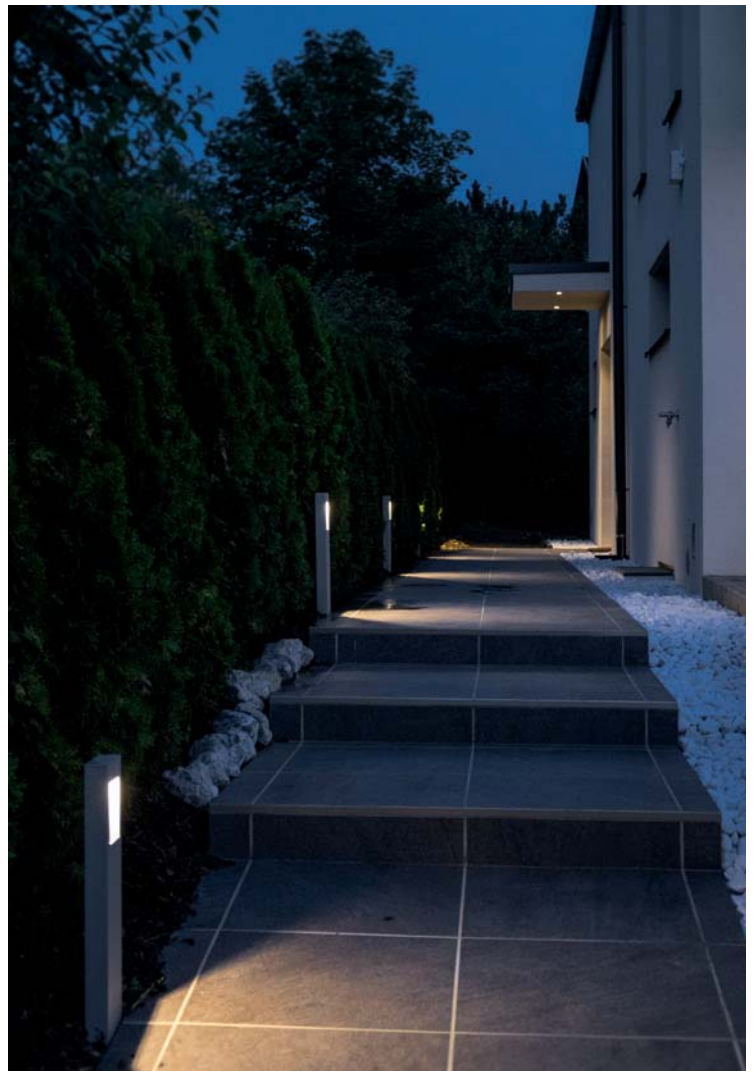



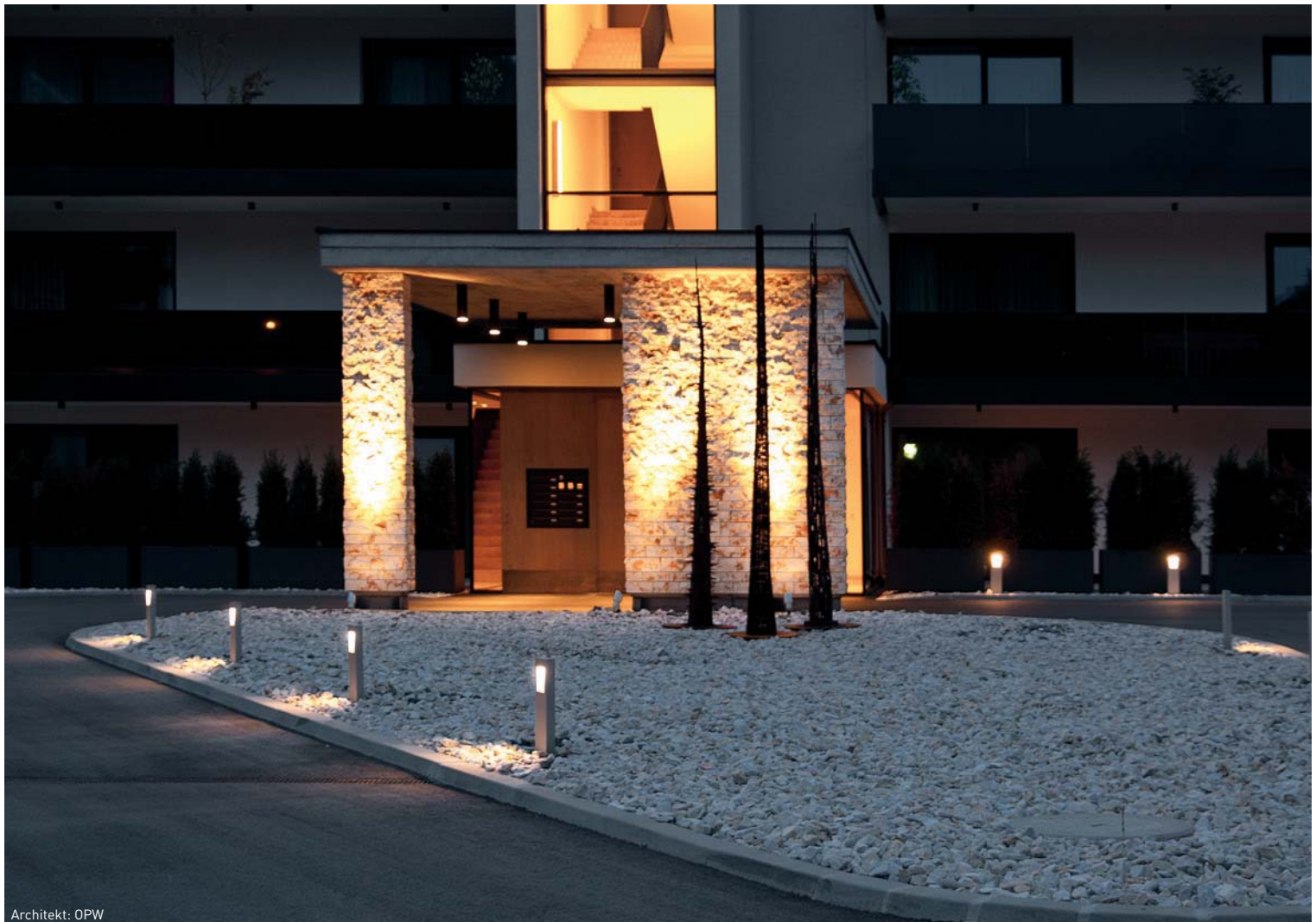

WEBSTER 400

LED-Pollerleuchte 5,4 W, Gehäuse aus Aluminiumguss, mit zweiseitigem Lichtaustritt und eingebautem Driver 230 V, IP54

LED-bollard luminaire 5,4 W, housing made of die-cast aluminium, with two-sided light emission and built-in driver 230 V, IP54

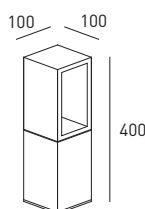
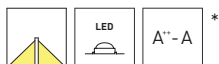

IP54

CODE	TYPE	COLOUR	LAMP	LUMEN*	POWER SUPPLY
D834	WEBSTER 400	grey	1x5,4W LED □ 3000K	540 lm	incl. driver

WEBSTER 900

LED-Pollerleuchte 5,4 W, Gehäuse aus Aluminiumguss, mit zweiseitigem Lichtaustritt und eingebautem Driver 230 V, IP54

LED-bollard luminaire 5,4 W, housing made of die-cast aluminium, with two-sided light emission and built-in driver 230 V, IP54

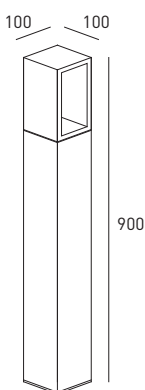
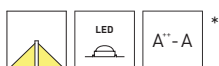

IP54

CODE	TYPE	COLOUR	LAMP	LUMEN*	POWER SUPPLY
D833	WEBSTER 900	grey	1x5,4W LED □ 3000K	540 lm	incl. driver

SYDNEY

LED-Pollerleuchte 5 W, Gehäuse aus Aluminiumguss, mit hochwertiger Glasoptik und eingebautem Driver 230 V, IP54

LED-bollard luminaire 5 W, housing made of die-cast aluminium, with high value optic lense and built-in driver 230 V, IP54

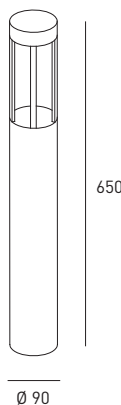
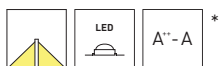

IP54

CODE	TYPE	COLOUR	LAMP	LUMEN*	POWER SUPPLY
D826	SYDNEY	grey	1x5W LED □ 3000K	550 lm	incl. driver
D830	SYDNEY	graphite	1x5W LED □ 3000K	550 lm	incl. driver

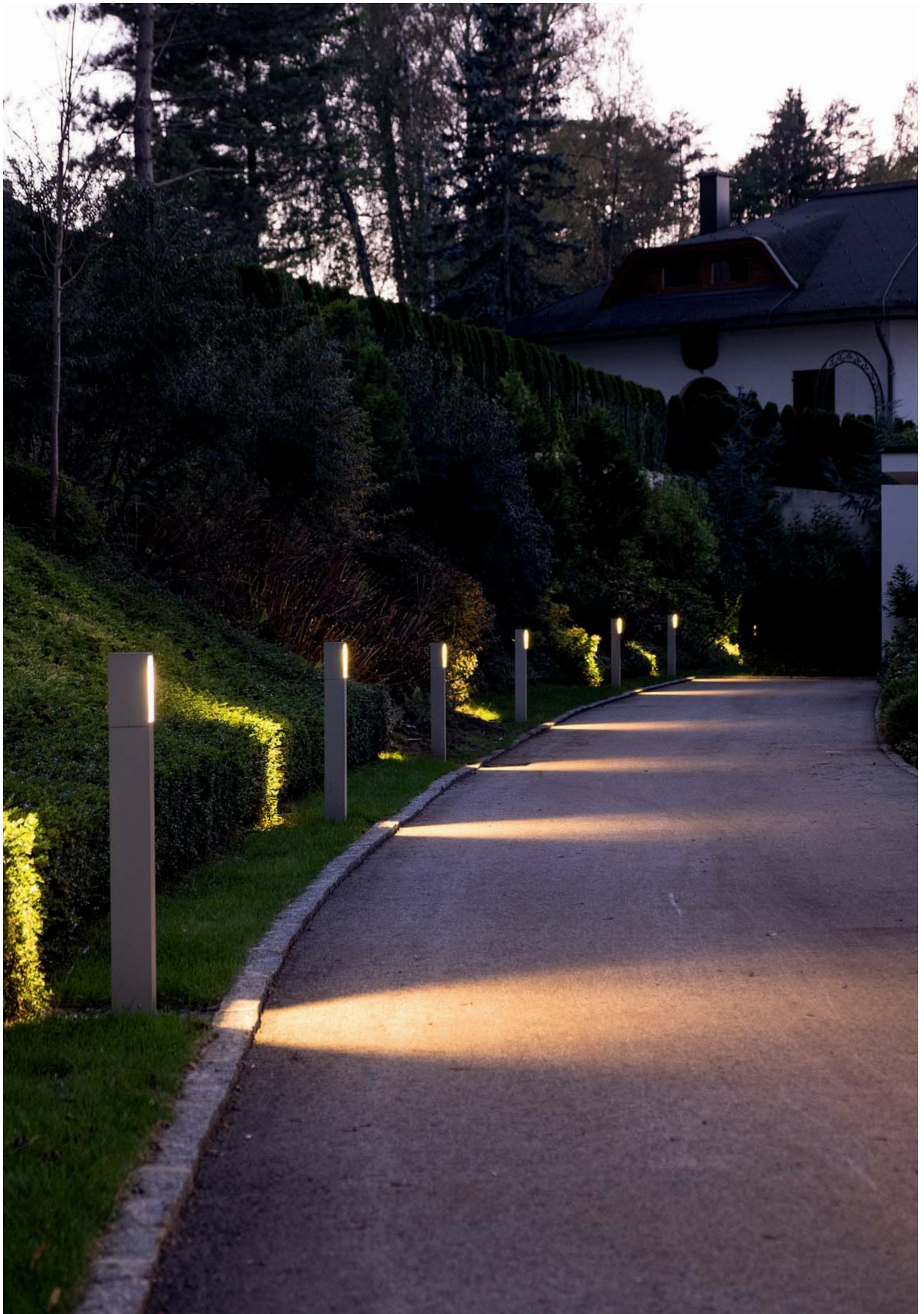

YORK 200

LED-Poller- und Wandleuchte 6 W, Gehäuse aus Aluminiumguss, mit hochwertiger Glasoptik und eingebautem Driver 230 V, IP54

LED-bollard and wall luminaire 6 W, housing made of die-cast aluminium, with high value optical lens and built-in driver 230 V, IP54

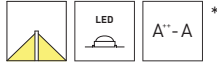
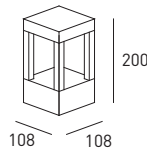

CODE	TYPE	COLOUR	LAMP	LUMEN*	POWER SUPPLY
D832	YORK 200	grey	1x6W LED □ 3000K	470 lm	incl. driver
D837	YORK 200	graphite	1x6W LED □ 3000K	470 lm	incl. driver

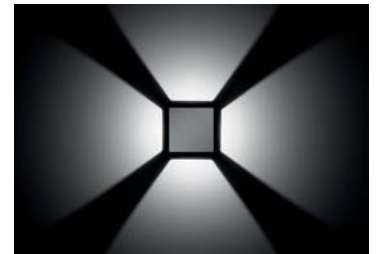
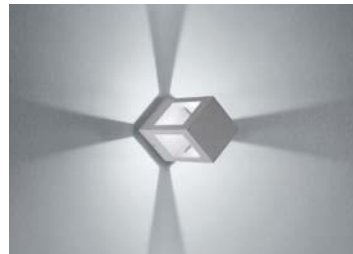

YORK

LED-Pollerleuchte 6 W, Gehäuse aus Aluminiumguss, mit hochwertiger Glasoptik und eingebautem Driver 230 V, IP54

LED-bollard luminaire 6 W, housing made of die-cast aluminium, with high value optic lense and built-in driver 230 V, IP54

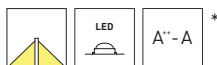
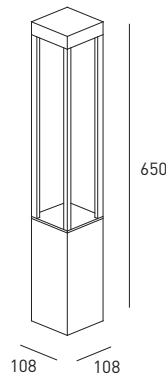

CODE	TYPE	COLOUR	LAMP	LUMEN*	POWER SUPPLY
D827	YORK	grey	1x6W LED □ 3000K	470 lm	incl. driver
D831	YORK	graphite	1x6W LED □ 3000K	470 lm	incl. driver



Projekt: Hotel Waldruhe Kartitsch

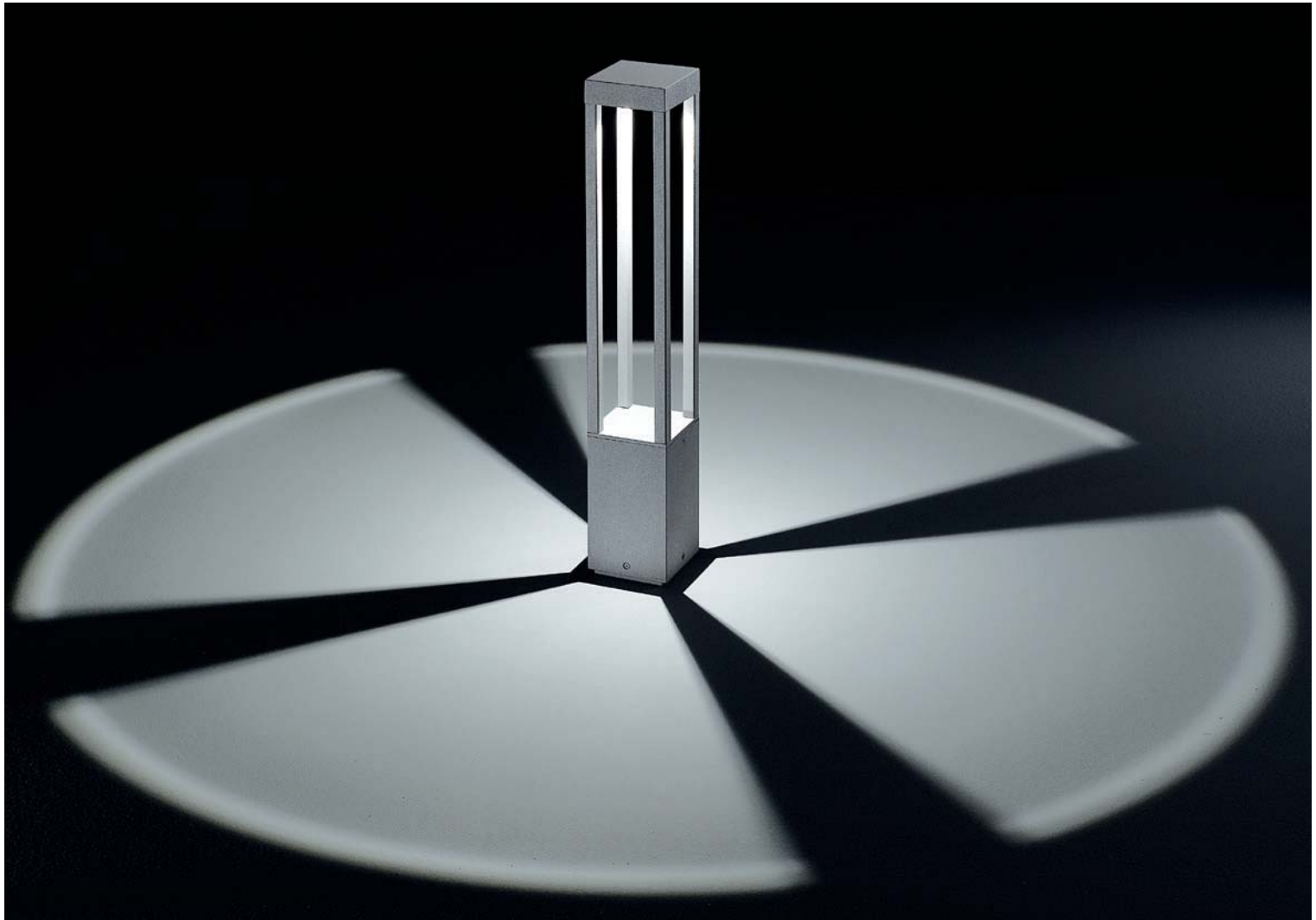

ATLANTIS 75

Außenstrahler für 230 V LED und Halogen oder 5 W LED, CRI>90, mit eingebautem Driver 230 V, Gehäuse aus massivem Aluminium mit Entblendungskonus, IP65 (GU10) bzw. IP68 (LED)

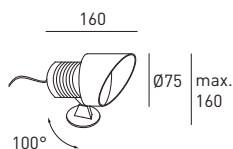

CODE	TYPE	COLOUR	LAMP	LUMEN*	POWER SUPPLY
D846	ATLANTIS 75	black	1x5W LED 25° □ 3000K	505 lm	incl. driver
D847	ATLANTIS 75	black	1xGU10 LED or 1x30W halogen	-	230 V

ATLANTIS 95

LED-Außenstrahler 7 W, CRI>90, mit eingebautem Driver 230 V, Gehäuse aus massivem Aluminium mit Entblendungskonus, IP68

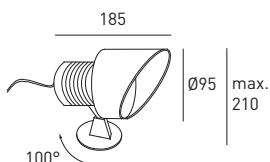

CODE	TYPE	COLOUR	LAMP	LUMEN*	POWER SUPPLY
D845	ATLANTIS 95	black	1x7W LED 30° □ 3000K	710 lm	incl. driver

ACCESSORIES



Erdspieß für Außenstrahler ATLANTIS 75 und ATLANTIS 95
Ground spike for outdoor fixtures ATLANTIS 75 and ATLANTIS 95

CODE	TYPE	COLOUR
D139	ATLANTIS GROUND SPIKE	black



Montagedose für Außenstrahler ATLANTIS 75 und ATLANTIS 95
Mounting box for outdoor fixtures ATLANTIS 75 and ATLANTIS 95

CODE	TYPE	COLOUR
D135	ATLANTIS MOUNTING BOX	black

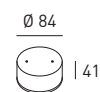

Kleinstverteilerdose IP68 für Kabel von 6,5 bis 12 mm, 3-polig mit Klemme, B x H x T: 95 x 44 x 24 mm
Micro junction box IP68 for cable from 6,5 to 12 mm, 3-pin with terminal, W x H x D: 95 x 44 x 24 mm

CODE	TYPE	COLOUR
5625	JUNCTION BOX IP68	orange

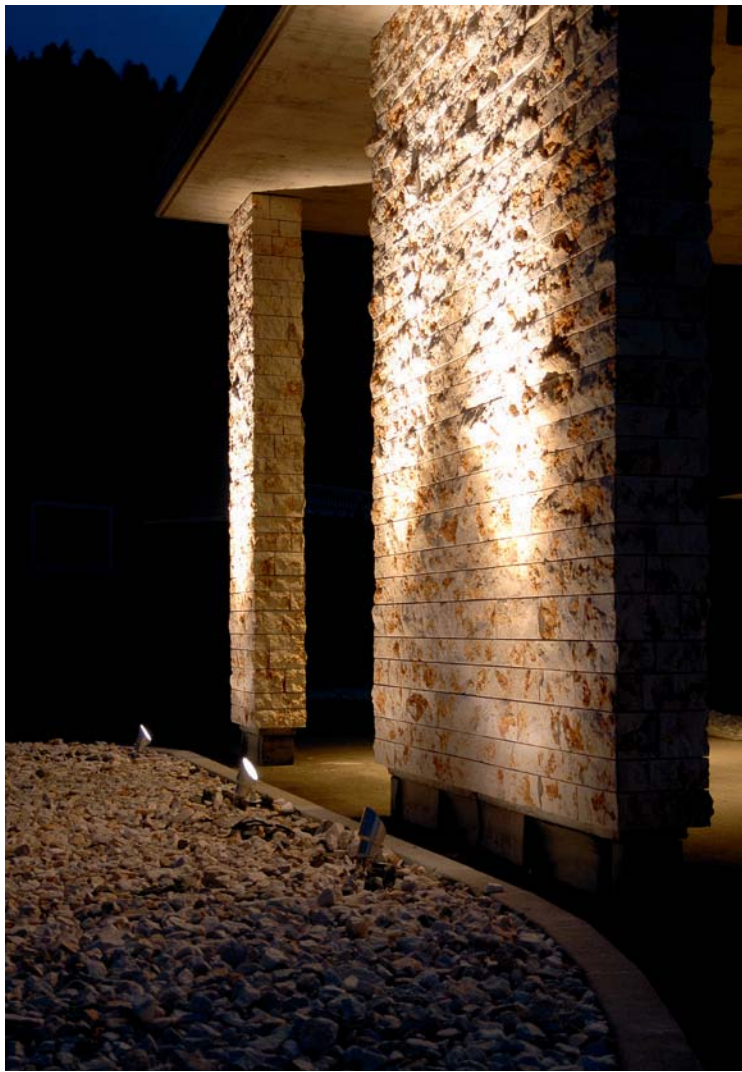

SCOTTY 3

LED-Bodeneinbaustrahler 3 W, CRI>90, mit hochwertigem Aluminiumreflektor und eingebautem Driver 230 V, schwenkbar 2x30°, Edelstahlring, inklusive Einbaugehäuse, IP67

LED-inground luminaire 3 W, CRI>90, with high-quality aluminium reflector and built-in driver 230 V, adjustable 2x30°, stainless steel ring, including mounting box, IP67

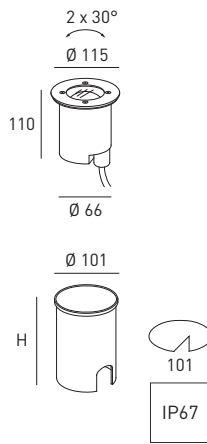
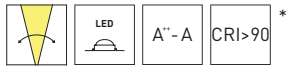

CODE	TYPE	COLOUR	LAMP	LUMEN*	POWER SUPPLY	H
D821	SCOTTY 3	stainless steel	1x3W LED 25° □ 3000K	408 lm	incl. driver	134 mm
15° und 38° Abstrahlwinkel auf Anfrage / 15° and 38° beam angle on request				H = Einbautiefe / recessed depth		

SCOTTY 6

LED-Bodeneinbaustrahler 8 W, CRI>90, mit hochwertigem Aluminiumreflektor und eingebautem Driver 230 V, schwenkbar 2x30°, Edelstahlring, inklusive Einbaugehäuse, IP67

LED-inground luminaire 8 W, CRI>90, with high-quality aluminium reflector and built-in driver 230 V, adjustable 2x30°, stainless steel ring, including mounting box, IP67

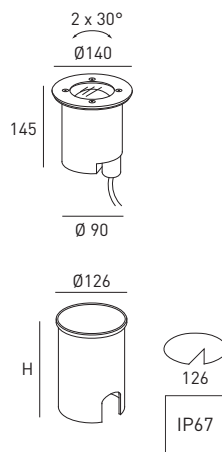
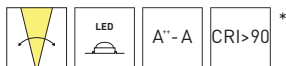

CODE	TYPE	COLOUR	LAMP	LUMEN*	POWER SUPPLY	H
D820	SCOTTY 6	stainless steel	1x8W LED 20° □ 3000K	800 lm	incl. driver	173 mm
30° und 40° Abstrahlwinkel auf Anfrage / 30° and 40° beam angle on request				H = Einbautiefe / recessed depth		

FRISCO

LED-Bodeneinbaustrahler 3 W, CRI>90, mit eingebautem Driver 230 V, schwenkbar 2x20°, Edelstahlring, inklusive Einbaugehäuse, IP67

LED-inground luminaire 3 W, CRI>90, with built-in driver 230 V, adjustable 2x20°, stainless steel ring, including mounting box, IP67

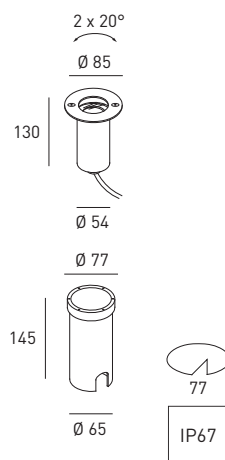
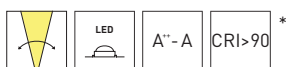

CODE	TYPE	COLOUR	LAMP	LUMEN*	POWER SUPPLY	H
D825	FRISCO	stainless steel	1x3W LED 40° □ 3000K	330 lm	incl. driver	145 mm
				H = Einbautiefe / recessed depth		

DOT

LED-Bodeneinbaustrahler
3 W, inklusive Einbaue-
häuse, Driver bitte separat
bestellen, IP67

LED-inground luminaire
3 W, including mounting
box, please order driver
separately, IP67

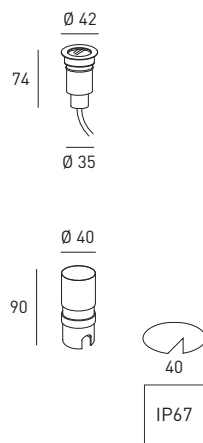
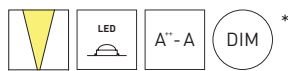

CODE	TYPE	COLOUR	LAMP	LUMEN*	POWER SUPPLY	H
D843	DOT	black	1x3W LED 40° □ 3000K 700mA	150 lm	excl. driver	90 mm
D823	DOT	alu	1x3W LED 40° □ 3000K 700mA	150 lm	excl. driver	90 mm

H = Einbautiefe / recessed depth

DOT Q

LED-Bodeneinbaustrahler
3 W, inklusive Einbaue-
häuse, Driver bitte separat
bestellen, IP67

LED-inground luminaire
3 W, including mounting
box, please order driver
separately, IP67

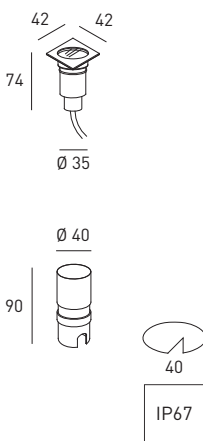
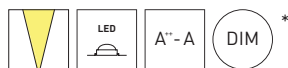

CODE	TYPE	COLOUR	LAMP	LUMEN*	POWER SUPPLY	H
D824	DOT Q	alu	1x3W LED 40° □ 3000K 700mA	150 lm	excl. driver	90 mm

H = Einbautiefe / recessed depth

ACCESSORIES



Kleinstverteilerdose IP68 für Kabel von 6,5 bis 12 mm, 3-polig mit Klemme,
B x H x T: 95 x 44 x 24 mm

Micro junction box IP68 for cable from 6,5 to 12 mm, 3-pin with terminal,
W x H x D: 95 x 44 x 24 mm

CODE	TYPE	COLOUR
5625	JUNCTION BOX IP68	orange

Driver siehe Seite 195 ff. / Driver see page 195 ff.



Architekt: GDC Innenarchitektur / Foto: Andrew Phelps



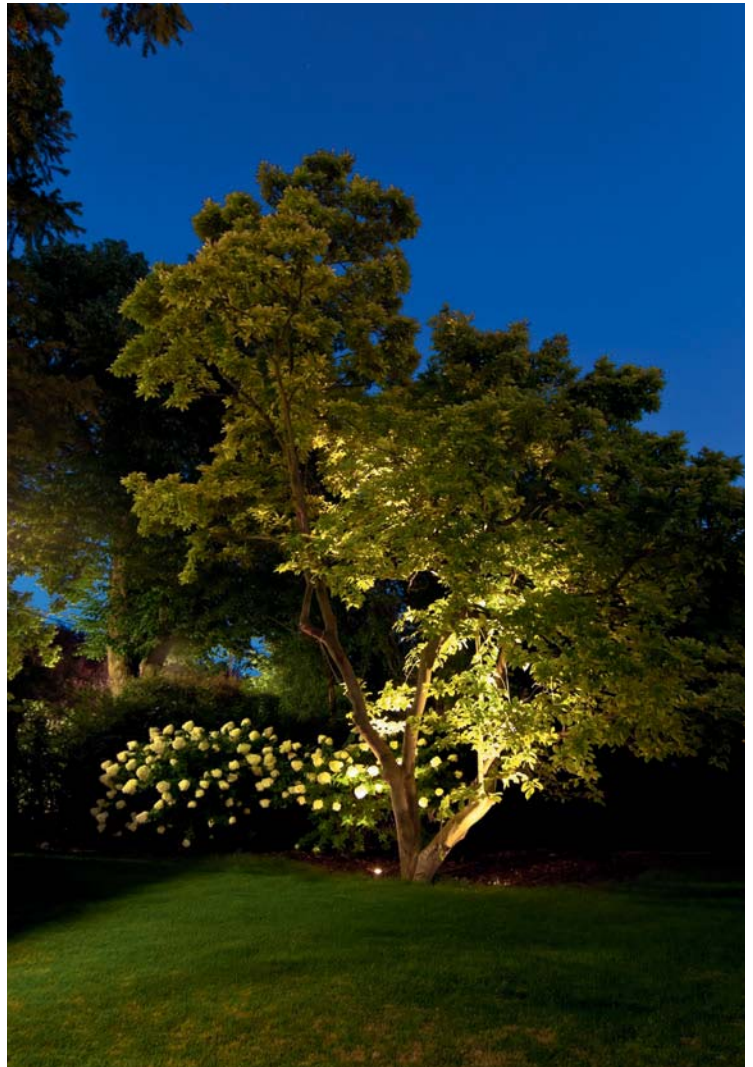
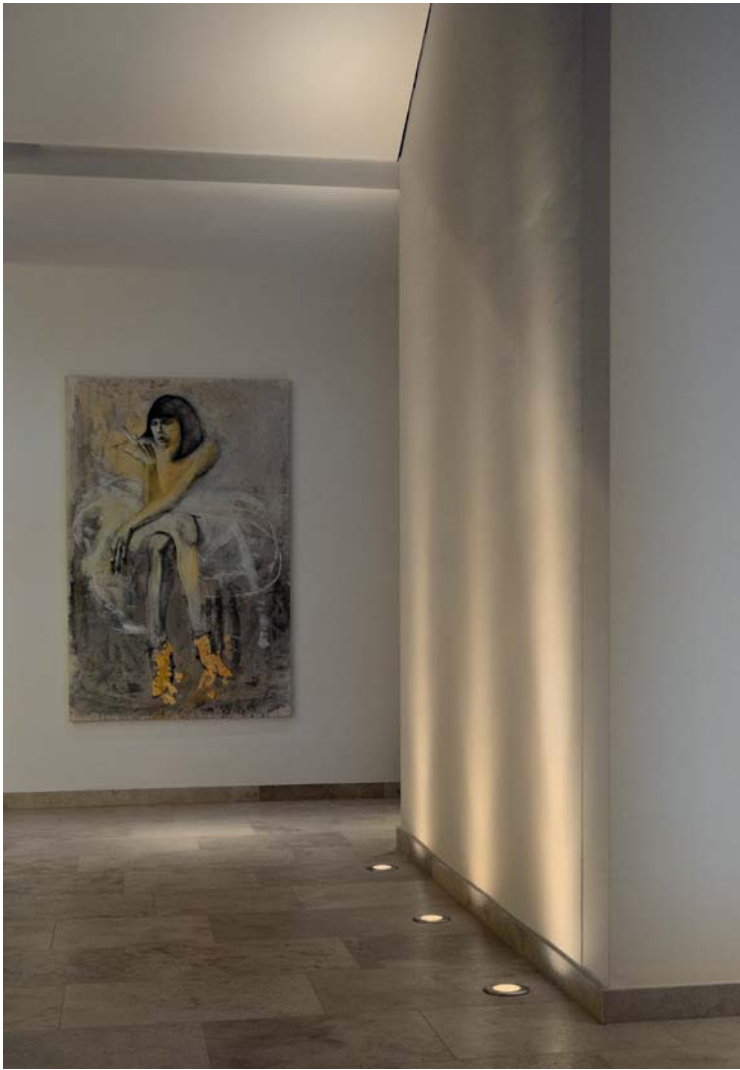

BEFESTIGUNGEN FÜR HÄNGELEUCHTEN / MOUNTING PARTS FOR PENDANTS

LP 5

Rechteckiges Gehäuse für die Befestigung von max. 5 Hängeleuchten, LED-Leuchten inklusive Driver, dimmbar mit Phasenanschnitt-/Phasenabschrittdimmer
Rectangular housing for mounting of maximum 5 pendants, LED pendants including driver, leading edge/trailing edge dimmable

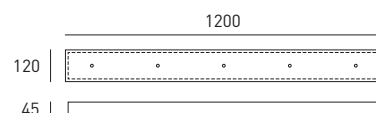

CODE	TYPE	COLOUR	LxWxH	WEIGHT	POWER SUPPLY
D-LP5	LP 5	white	1200x120x45 mm	2,8 kg	230 V phase dim

LP 8

Rechteckiges Gehäuse für die Befestigung von max. 8 Hängeleuchten, LED-Leuchten inklusive Driver, dimmbar mit Phasenanschnitt-/Phasenabschrittdimmer
Rectangular housing for mounting of maximum 8 pendants, LED pendants including driver, leading edge/trailing edge dimmable

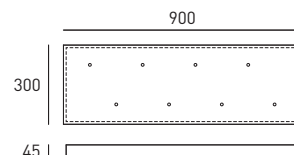

CODE	TYPE	COLOUR	LxWxH	WEIGHT	POWER SUPPLY
D-LP8	LP 8	white	900x300x45 mm	6,7 kg	230 V phase dim

LP 7

Rundes Gehäuse für die Befestigung von max. 7 Hängeleuchten, LED-Leuchten inklusive Driver, dimmbar mit Phasenanschnitt-/Phasenabschrittdimmer
Round housing for mounting of maximum 7 pendants, LED pendants including driver, leading edge/trailing edge dimmable

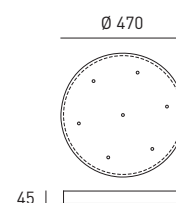

CODE	TYPE	COLOUR	LxWxH	WEIGHT	POWER SUPPLY
D-LP7	LP 7	white	Ø 470x45 mm	4,2 kg	230 V phase dim

STAR

Rundes Gehäuse für dezentrale Befestigung von max. 6 Hängeleuchten (CLEO/LILLI: max. 3 Leuchten), LED-Leuchten inklusive Driver, dimmbar mit Phasenanschnitt-/Phasenabschrittdimmer
Round housing for decentralised mounting of maximum 6 pendants (CLEO/LILLI: max. 3 pendants), LED pendants including driver, leading edge/trailing edge dimmable

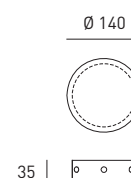

CODE	TYPE	COLOUR	LxWxH	WEIGHT	POWER SUPPLY
D-STAR	STAR	white	Ø 140x35 mm	0,3 kg	230 V phase dim

CABLE HOLDER

Kabelhalterungen für dezentrale Befestigung
Cable holder for decentralised mounting

CODE	TYPE	COLOUR	LxWxH
D136	CABLE HOLDER	white	for Ø 2-6 mm wires
D137	CABLE HOLDER	black	for Ø 2-6 mm wires

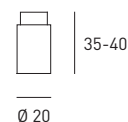

CABLE KITS 5

Sonderlängen-KITs 5.000 mm für Hängeleuchten CLEO, HANGING BALI, LILLI und SPAGO, Gesamtlänge inkl. Leuchte 5.000 mm
Special length KITs 5.000 mm for pendants CLEO, HANGING BALI, LILLI and SPAGO, total length including fixture 5.000 mm

CODE	TYPE	L
D105	CABLE KIT 5 CLEO	5000 mm
D106	CABLE KIT 5 HANGING BALI	5000 mm
D107	CABLE KIT 5 LILLI	5000 mm
D108	CABLE KIT 5 SPAGO	5000 mm

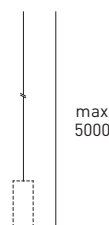

SPAGO ANWENDUNGSBEISPIELE / SPAGO APPLICATION EXAMPLES

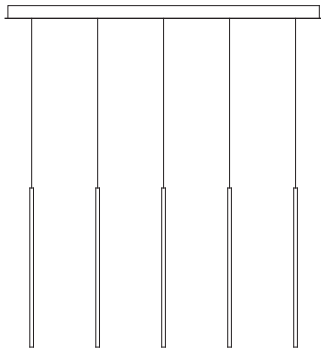

=

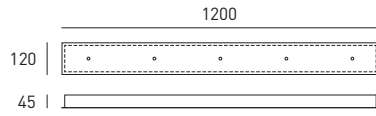

+

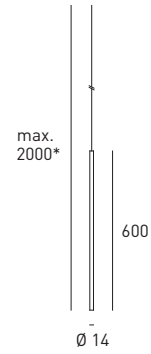

1xLP 5

5xSPAGO 60 T

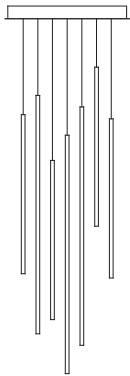

=

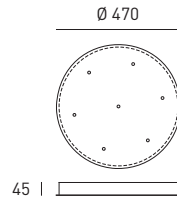

+

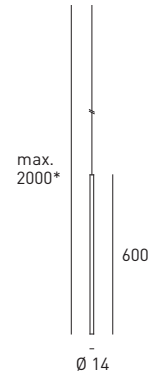

+

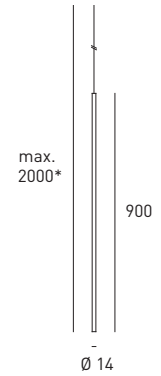

1xLP 7

4xSPAGO 60 T

3xSPAGO 90 T

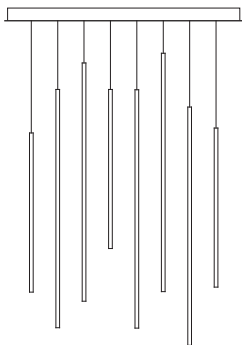

=

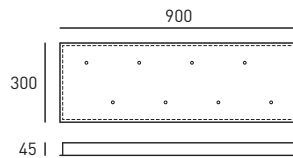

+

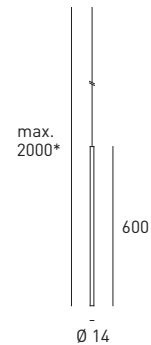

+

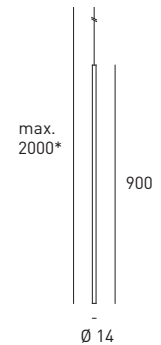

1xLP 8

3xSPAGO 60 T

5xSPAGO 90 T

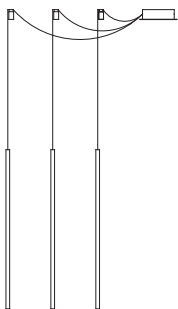

=

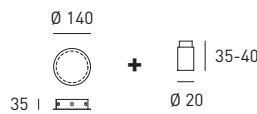

+

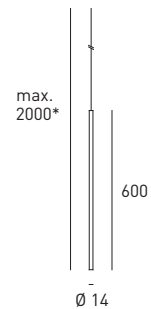

1xSTAR

3xCABLE HOLDER

3xSPAGO 60 T

*CABLE KIT 5 SPAGO mit max. 5.000 mm Länge, siehe S. 184 / *CABLE KIT 5 SPAGO with 5.000 mm length, see page 184

SPAGO Produktinformationen siehe Seite 42 / SPAGO product information see page 42

CLEO ANWENDUNGSBEISPIELE / CLEO APPLICATION EXAMPLES

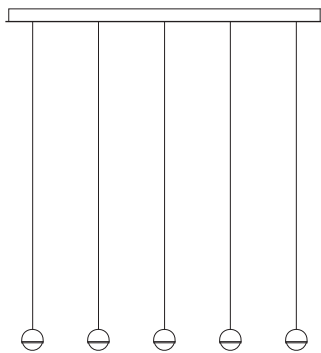

=

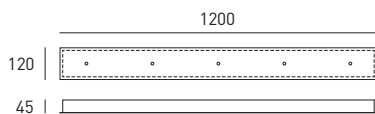

+

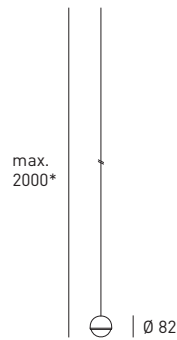

1xLP 5

5xCLEO

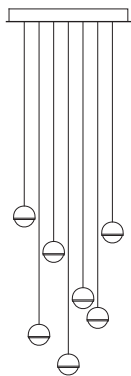

=

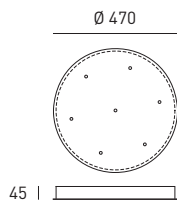

+

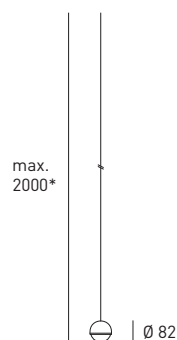

1xLP 7

7xCLEO

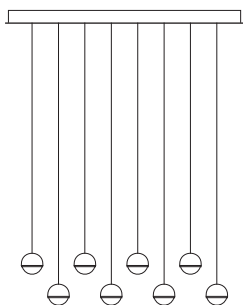

=

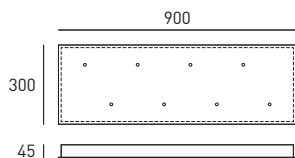

+

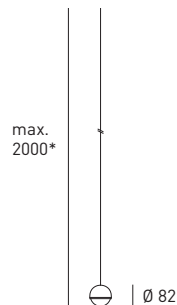

1xLP 8

8xCLEO

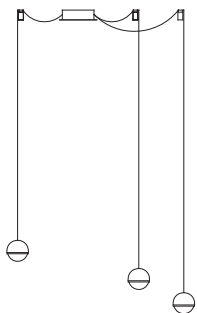

=

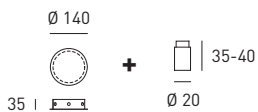

+

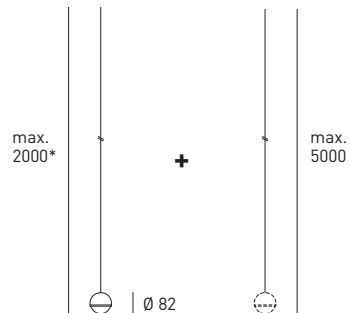

1xSTAR

3xCABLE HOLDER

3xCLEO

1xCABLE KIT 5 CLEO

*CABLE KIT 5 CLEO mit max. 5.000 mm Länge, siehe S. 184 / *CABLE KIT 5 CLEO with 5.000 mm length, see page 184

LILLI ANWENDUNGSBEISPIELE / LILLI APPLICATION EXAMPLES

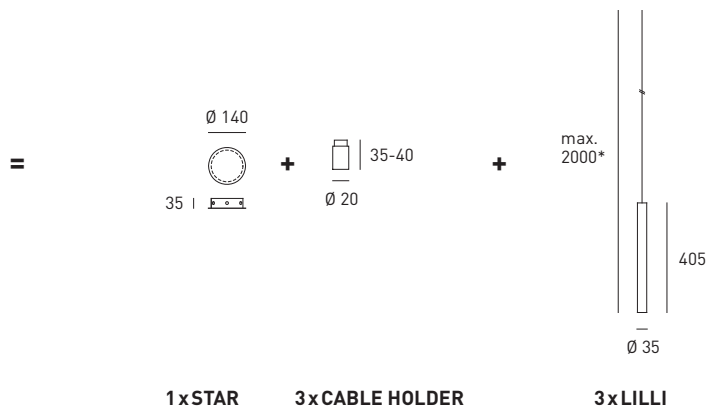
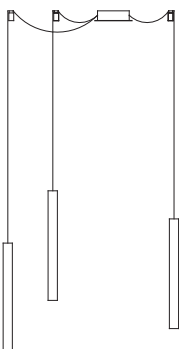
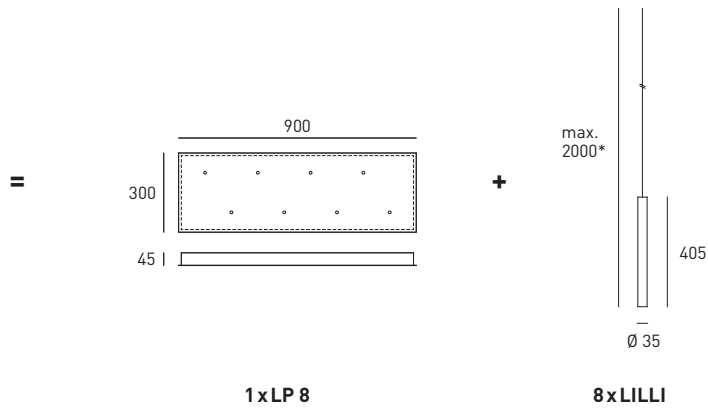
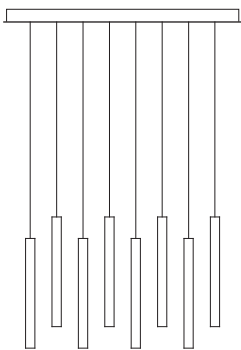
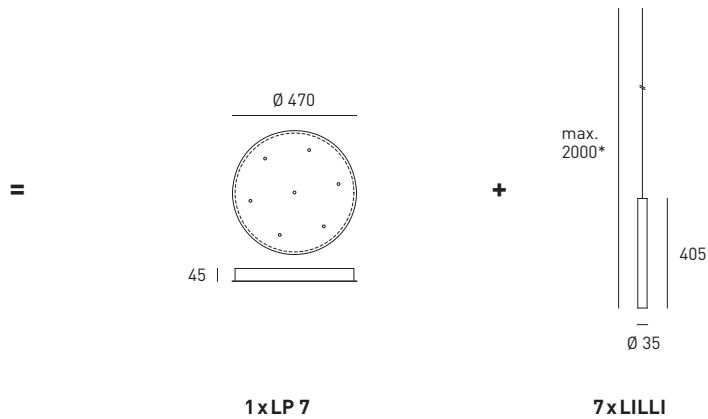
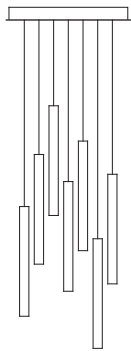
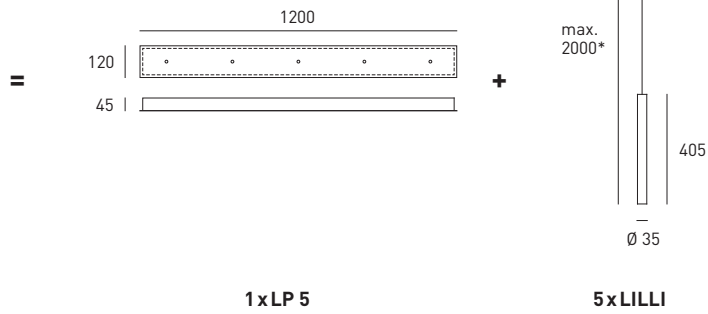
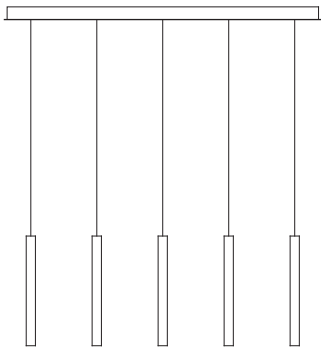

*CABLE KIT 5 LILLI mit max. 5.000 mm Länge, siehe S. 184 / *CABLE KIT 5 LILLI with 5.000 mm length, see page 184

LILLI Produktinformationen siehe Seite 46 / LILLI product information see page 46

HANGING BALI ANWENDUNGSBEISPIELE / HANGING BALI APPLICATION EXAMPLES

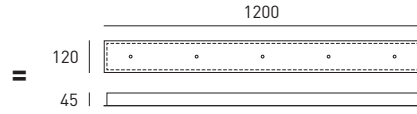
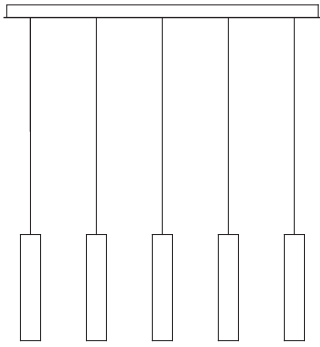

1xLP 5

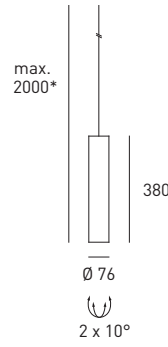

5xHANGING BALI L

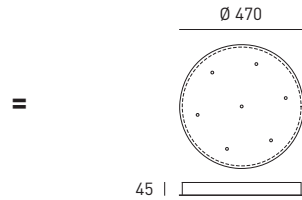
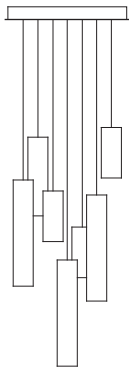

1xLP 7

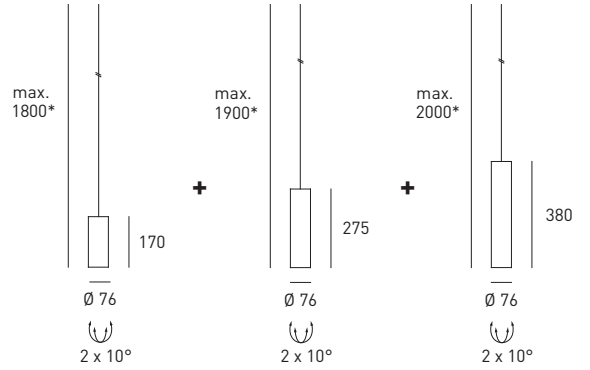

3xHANGING BALI S

1xHANGING BALI

3xHANGING BALI L

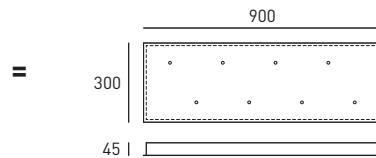
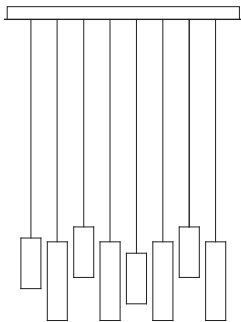

1xLP 8

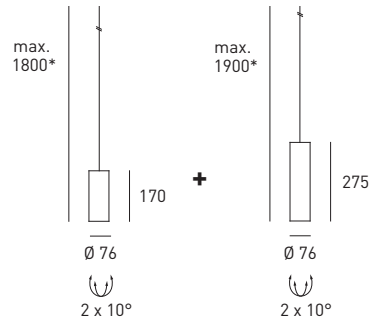

4xHANGING BALI S

4xHANGING BALI

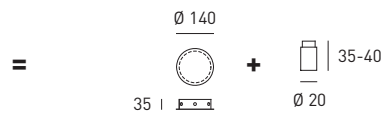
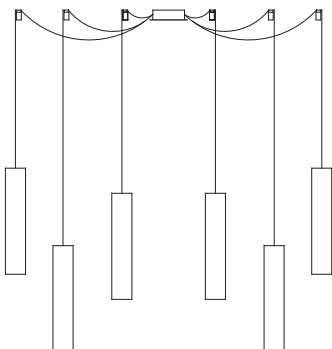

1xSTAR

6xCABLE HOLDER

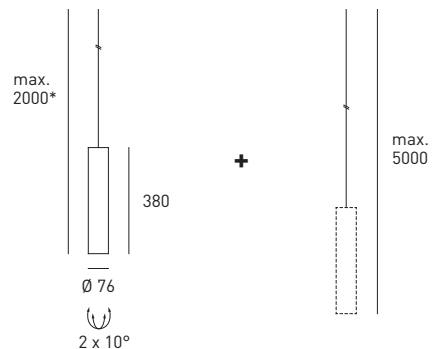

6xHANGING BALI L

4xCABLE KIT 5 HANGING BALI

*CABLE KIT 5 HANGING BALI mit max. 5.000 mm Länge, siehe S. 184 / *CABLE KIT 5 HANGING BALI with 5.000 mm length, see page 184

LEGENDE / LEGEND



Abstrahlwinkel
Beam angle



Leuchtmittel (z. B.: LED)
Lamp (e.g.: LED)



Energieeffizienz (z. B.: Effizienzklasse A⁺⁺ - A)
Energy efficiency (e.g.: efficiency class A⁺⁺ - A)



Lumenwerte sind Nominalwerte (Lichtstrom eines LED-Moduls bei 25°C Betriebstemperatur), z. B.: für 3000K (warmweiß) / 4000K (neutralweiß). Aktuelle Lichtstromwerte und EULUMDAT auf Anfrage.
Lumen data are nominal value (luminous flux of a LED-module at 25°C operating temperature), e.g.: for 3000K (warm white) / 4000K (neutral white). Latest luminous flux data and EULUMDAT on request.

ENERGIEEFFIZIENZ / ENERGY EFFICIENCY



Informationen zur Energieeffizienz unserer Leuchten, gemäß den EU-Verordnungen 874/2012 und 518/2014, finden Sie auf www.eulabel.de

Ein Teil unserer Leuchten enthält eingebaute LED-Lampen. Die Lampen können in der Leuchte nicht ausgetauscht werden.

Information about energy efficiency of our luminaires, according to EU regulations 874/2012 und 518/2014, you will find on www.eulabel.de in all European languages.

A part of our luminaires contains built-in LED lamps. These lamps cannot be changed in the luminaire.



PEFC zertifiziert

Dieses Produkt stammt aus nachhaltig bewirtschafteten Wäldern und kontrollierten Quellen.
This product is from sustainably managed forests, recycled and controlled sources.

www.pefc.at

Wir behalten uns das Recht vor, technische und formale Änderungen an unseren Produkten ohne vorherige Ankündigung vorzunehmen. Alle Maße in mm. Druckfehler vorbehalten.











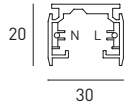

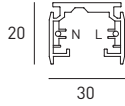





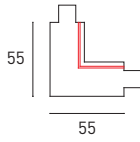

Fotos Seite 3: Reinhard Fasching, Andrea Ruster, Martin Steinhäler

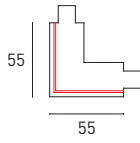
All dimensions and specifications are subject to change without notice. All dimensions in mm. Typographical errors excepted.

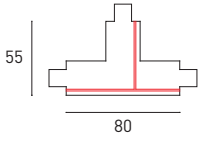
Photos page 3: Reinhard Fasching, Andrea Ruster, Martin Steinhäler

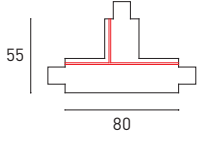

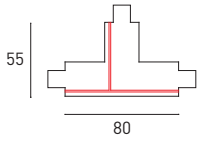





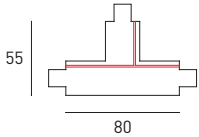

1-PHASEN STROMSCHIENEN / 1-PHASE LIGHTING TRACKS

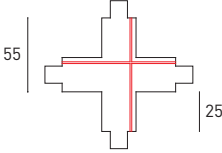
verfügbar in ■ schwarz, □ weiß / available in ■ black, □ white

TRACK 1 – P1	1-Phasen Stromschiene, L=1000mm 1-phase lighting track, L=1000mm	D-GB2100-2 ■ D-GB2100-3 □		
TRACK 2 – P1	1-Phasen Stromschiene, L=2000mm 1-phase lighting track, L=2000mm	D-GB2200-2 ■ D-GB2200-3 □		
END FEED P1	1-Phasen Endeinspeisung, rechts* 1-phase end power feed, right*	D-GB11-2 ■ D-GB11-3 □		
END FEED P1	1-Phasen Endeinspeisung, links* 1-phase end power feed, left*	D-GB12-2 ■ D-GB12-3 □		
MIDDLE FEED P1	1-Phasen Mitteleinspeisung 1-phase center power feed	D-GB14-2 ■ D-GB14-3 □		
STRAIGHT CONNECTOR P1	1-Phasen Linearverbinder 1-phase straight connector	D-GB21-2 ■ D-GB21-3 □		
L-FEED P1	1-Phasen L-Verbinder, rechts* 1-phase L-feed, right*	D-GB34-2 ■ D-GB34-3 □		
L-FEED P1	1-Phasen L-Verbinder, links* 1-phase L-feed, left*	D-GB35-2 ■ D-GB35-3 □		
T-FEED P1	1-Phasen T-Verbinder, rechts-rechts* 1-phase T-feed, right-right*	D-GB36-2 ■ D-GB36-3 □		
T-FEED P1	1-Phasen T-Verbinder, links-links* 1-phase T-feed, left-left*	D-GB37-2 ■ D-GB37-3 □		
T-FEED P1	1-Phasen T-Verbinder, rechts-links* 1-phase T-feed, right-left*	D-GB39-2 ■ D-GB39-3 □		

1-PHASEN STROMSCHIENEN / 1-PHASE LIGHTING TRACKS

verfügbar in ■ schwarz, □ weiß / available in ■ black, □ white

T-FEED P1	1-Phasen T-Verbinder, links-rechts* 1-phase T-feed, left-right*	D-GB40-2 ■ D-GB40-3 □		
X-FEED P1	1-Phasen X-Verbinder 1-phase X-feed	D-GB38-2 ■ D-GB38-3 □		
END CAP P1	1-Phasen Endkappe 1-phase end cap	D-GB41-2 ■ D-GB41-3 □		
ADAPTER P1	1-Phasen Adapter (max. 5 kg) 1-phase adapter (maximum 5 kg)	D-GB66-2 ■ D-GB66-3 □		
STRAIN RELIEF P1/P3	1-Phasen / 3-Phasen Zugentlastung M10x1 1-phase / 3-phase strain relief M10x1	D-XTSA510-2 ■ D-XTSA510-3 □		
NIPPLE P1	1-Phasen Nippel M10 1-phase nipple M10	D-GA57/10-2 ■ D-GA57/10-3 □		
WIRE SUSPENSION P1	1-Phasen Seilabhängung L = 3000 mm (max. 150 kg / Aufhängung bitte separat bestellen) 1-phase wire suspension L = 3000 mm (maximum 150 kg / please order suspension clamp separately)	D-SPW1-2/3M ■ D-SPW1-3/3M □		
SUSPENSION CLAMP	1-Phasen Aufhängung, alu anodisiert 1-phase suspension clamp, alu anodised	D-GBS33-9 □		

Mounting Examples

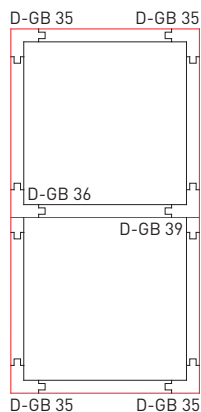

Use of L- and T-Accessories:
Ground Polarity
outside

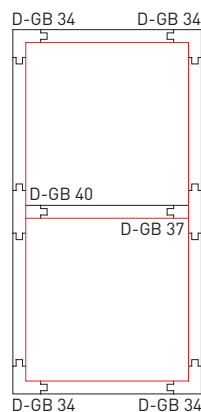



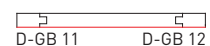







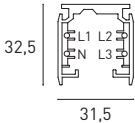

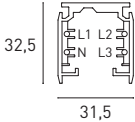

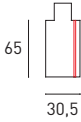

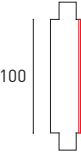

Use of L- and T-Accessories:
Ground Polarity
inside

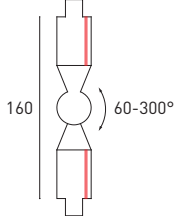

Use of End Feeds

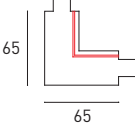

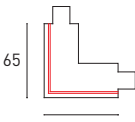







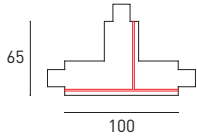

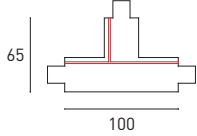

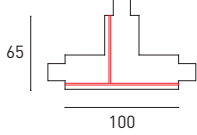

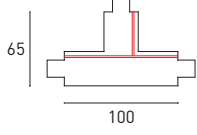
3-PHASEN STROMSCHIENEN / 3-PHASE LIGHTING TRACKS

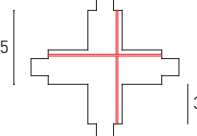
verfügbar in ■ schwarz, □ weiß / available in ■ black, □ white

TRACK 1 – P3	3-Phasen Stromschiene, L=1000mm 3-phase lighting track, L=1000mm	D-XTS4100-2	■		
		D-XTS4100-3	□		
TRACK 2 – P3	3-Phasen Stromschiene, L=2000mm 3-phase lighting track, L=2000mm	D-XTS4200-2	■		
		D-XTS4200-3	□		
END FEED P3	3-Phasen Endeinspeisung, rechts* 3-phase end power feed, right*	D-XTS11-2	■		
		D-XTS11-3	□		
END FEED P3	3-Phasen Endeinspeisung, links* 3-phase end power feed, left*	D-XTS12-2	■		
		D-XTS12-3	□		
MIDDLE FEED P3	3-Phasen Mitteleinspeisung 3-phase center power feed	D-XTS14-2	■		
		D-XTS14-3	□		
STRAIGHT CONNECTOR P3	3-Phasen Linearverbinder 3-phase straight connector	D-XTS21-2	■		
		D-XTS21-3	□		
FLEXIBLE CONNECTOR P3	Flexibler 3-Phasen Verbinder, 0° - 360° Flexible 3-phase connector, 0° - 360°	D-XTS23-2	■		
		D-XTS23-3	□		
ADJUSTABLE CONNECTOR P3	Einstellbarer 3-Phasen Verbinder, 60° - 300° Adjustable 3-phase connector, 60° - 300°	D-XTS24-2	■		
		D-XTS24-3	□		
L-FEED P3	3-Phasen L-Verbinder, rechts* 3-phase L-feed, right*	D-XTS34-2	■		
		D-XTS34-3	□		
L-FEED P3	3-Phasen L-Verbinder, links* 3-phase L-feed, left*	D-XTS35-2	■		
		D-XTS35-3	□		



3-PHASEN STROMSCHIENEN / 3-PHASE LIGHTING TRACKS

verfügbar in ■ schwarz, □ weiß / available in ■ black, □ white

T-FEED P3	3-Phasen T-Verbinder, rechts-rechts* 3-phase T-feed, right-right*	D-XTS36-2 ■ D-XTS36-3 □		
T-FEED P3	3-Phasen T-Verbinder, links-links* 3-phase T-feed, left-left*	D-XTS37-2 ■ D-XTS37-3 □		
T-FEED P3	3-Phasen T-Verbinder, rechts-links* 3-phase T-feed, right-left*	D-XTS39-2 ■ D-XTS39-3 □		
T-FEED P3	3-Phasen T-Verbinder, links-rechts* 3-phase T-feed, left-right*	D-XTS40-2 ■ D-XTS40-3 □		
X-FEED P3	3-Phasen X-Verbinder 3-phase X-feed	D-XTS38-2 ■ D-XTS38-3 □		
END CAP P3	3-Phasen Endkappe 3-phase end cap	D-XTS41-2 ■ D-XTS41-3 □		
MULTI ADAPTER™ P3	3-Phasen Multi-Adapter™ (max. 5 kg) 3-phase multi adapter™ (maximum 5 kg)	D-GA69-2 ■ D-GA69-3 □		
STRAIN RELIEF P1/P3	1-Phasen / 3-Phasen Zugentlastung M10x1 1-phase / 3-phase strain relief M10x1	D-XTSA510-2 ■ D-XTSA510-3 □		
NIPPLE P3	3-Phasen Nippel M10, alu 3-phase nipple M10, alu	D-XTS58/8-9 □		
WIRE SUSPENSION 1.5 P3	3-Phasen Seilabhängung inkl. Aufhängung, L = 1500 mm (max. 150 kg) 3-phase wire suspension including suspension clamp, L = 1500 mm (maximum 150 kg)	D-SPW12SK-2/1.5M ■ D-SPW12SK-3/1.5M □		
WIRE SUSPENSION 3.0 P3	3-Phasen Seilabhängung inkl. Aufhängung, L = 3000 mm (max. 150 kg) 3-phase wire suspension including suspension clamp, L = 3000 mm (maximum 150 kg)	D-SPW12SK-2/3M ■ D-SPW12SK-3/3M □		

3-PHASEN STROMSCHIENEN / 3-PHASE LIGHTING TRACKS

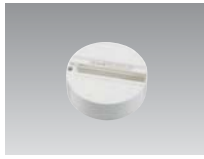
verfügbar in ■ schwarz, □ weiß / available in ■ black, □ white

FIX POINT™ P3	Punktauslass für 3-Phasen Adapter Fix Point™ for 3-phase adapter	D-GA70-2 ■ D-GA70-3 □	
BENDING TOOL P3	3-Phasen Biegewerkzeug für Kupferleitungen, blau 3-phase bending tool for power wires, blue	D-XTSV12 ■	

Mounting Examples

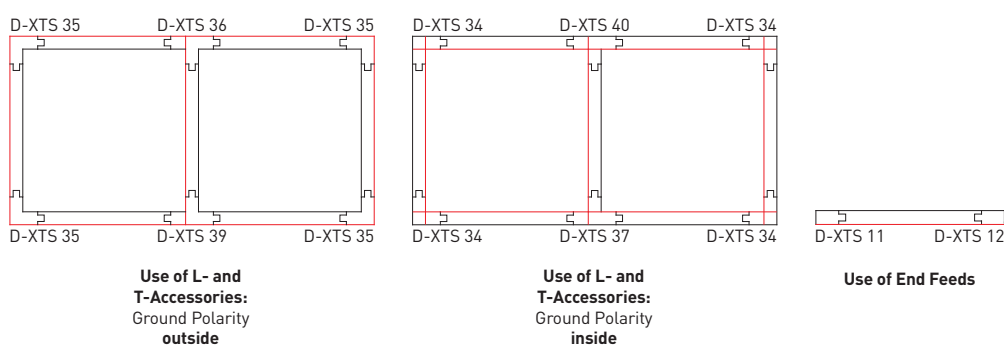

GLOBAL light

GLOBAL trac®, MULTI Adapter™ and FIX Point™ are registered trademarks of Nordic Aluminium

TRANSFORMATOREN 12 V / TRANSFORMER 12 V

TRANSFORMATOREN 70 VA	Elektronischer Transformator 70 VA, kompakte Bauform, Anschlussklemme primär 2-polig / sekundär 4-polig, LED max. 45 VA Electronic transformer 70 VA, compact design, terminal block: 2 pole on primary side / 4 pole on secondary side, LED max. 45 VA				
	CODE	TYPE	VOLTAGE	DIMMABLE	LxWxH
TRANSFORMATOREN 105 VA	Elektronischer Transformator 105 VA, kompakte Bauform, Anschlussklemme primär 2-polig / sekundär 4-polig, LED max. 60 VA Electronic transformer 105 VA, compact design, terminal block: 2 pole on primary side / 4 pole on secondary side, LED max. 60 VA				
	CODE	TYPE	VOLTAGE	DIMMABLE	LxWxH
	VERBATIM 70	TRANSFORMER 0-70 VA	12V / 240V	PHASE DIM	113x44x28 mm
	LUXIA 105	TRANSFORMER 0-105 VA	12V / 240V	PHASE DIM	119x37x30 mm

DRIVER / DRIVER

	CODE	POWER	CONSTANT CURRENT	DIMMABLE	LxWxH
DRIVER 250 mA	CC-250-06-PC	4,0 - 6,0 W	250 mA	PHASE DIM	47x43x20 mm
DRIVER 350 mA	CC-350-04s	1,0 - 4,0 W	350 mA	-	48x26x19 mm
	CC-350-08	1,0 - 8,0 W	350 mA	-	68x35x21 mm
	CC-350-13-PC	6,5 - 13,0 W	350 mA	PHASE DIM	120x53x25 mm
	CC-350-15	1,0 - 15,0 W	350 mA	-	115x34x19 mm
	CC-350-18-PC	9,5 - 18,0 W	350 mA	PHASE DIM	120x53x30 mm
DRIVER 500 mA	CC-500-06	1,0 - 6,0 W	500 mA	-	68x35x22 mm
	CC-500-06s	1,4 - 6,4 W	500 mA	-	49x27x20 mm
	CC-500-06-PC	3,0 - 6,0 W	500 mA	PHASE DIM	82x41x22 mm
	CC-500-10-PC	6,0 - 10,0 W	500 mA	PHASE DIM	85x41x22 mm
	CC-500-12	1,0 - 12,0 W	500 mA	-	115x34x19 mm
	CC-500-18-PC	9,0 - 18,0 W	500 mA	PHASE DIM	120x53x30 mm
	CC-500-20	1,0 - 20,0 W	500 mA	-	122x38x28 mm
	CC-500-21-PC	14,0 - 21,0 W	500 mA	PHASE DIM	102x51x30 mm
DRIVER 700 mA	CC-700-06s	1,9 - 6,7 W	700 mA	-	49x27x20 mm
	CC-700-10-PC	6,0 - 10,0 W	700 mA	PHASE DIM	85x41x22 mm
	CC-700-15-PC	9,0 - 14,5 W	700 mA	PHASE DIM	85x41x22 mm
	CC-700-25-PC	12,5 - 25,0 W	700 mA	PHASE DIM	120x53x30 mm
	CC-700-35-PC	19,0 - 35,0 W	700 mA	PHASE DIM	153x54x36 mm
DRIVER 900 mA	CC-900-40	20,0 - 40,0 W	900 mA	-	167x46x30 mm
DRIVER 1050 mA	CC-1050-22	2,0 - 22,0 W	1050 mA	-	122x38x28 mm
DRIVER UNIVERSAL	CC-UNI-42	1,1 - 15,0 W	350 mA	-	147x43x30 mm
		1,5 - 22,0 W	500 mA		
		2,1 - 31,0 W	700 mA		
		2,7 - 38,0 W	900 mA		
		3,2 - 42,0 W	1050 mA		
	CC-UNI-DIM-20	4,0 - 12,0 W	250 mA	DALI	110x52x22 mm
		1,0 - 17,0 W	350 mA		
		1,0 - 20,0 W	500 mA		
	CC-UNI-DIM-20-M	1,0 - 20,0 W	700 mA	1-10 V DALI PUSH	150x52x28 mm
		1,5 - 15,0 W	250 mA		
		2,1 - 15,0 W	350 mA		
		3,0 - 20,0 W	500 mA		
	CC-UNI-DIM-60	4,2 - 20,0 W	700 mA	1-10 V DALI PUSH	125x79x22 mm
		1,0 - 25,0 W	350 mA		
		1,0 - 35,0 W	500 mA		
		1,0 - 50,0 W	700 mA		
		1,0 - 60,0 W	900 mA		
	CC-UNI-DIM-60-M	1,0 - 60,0 W	1050 mA	1-10 V DALI PUSH	202x58x30 mm
		2,1 - 20,3 W	2x350 mA		
		3,0 - 29,0 W	2x500 mA		
4,2 - 29,4 W		2x700 mA			
5,4 - 30,0 W		2x900 mA			

DRIVER DIMMBAR / DRIVER DIMMABLE

1-10 V: dimmbar mit 1-10 V Driver (separate Steuerleitung notwendig) / dimmable via 1-10 V driver (separate control cable required)

DALI: dimmbar mit DALI Driver (separate Steuerleitung notwendig) / dimmable via DALI driver (separate control cable required)

PC: dimmbar mit Phasenanschnitt-/Phasenabschnittdimmer / dimmable with leading edge/trailing edge dimmer

UNI: Universalgerät, dimmbar mit 1-10 V, DALI oder PUSH (über Taster), Konstantstrom umschaltbar / universal device, dimmable via 1-10 V, DALI or PUSH (with pushbutton), constant current switchable

Weitere Drivervarianten, Driverzubehör und RGB-Steuerung auf Anfrage. Technische Änderungen vorbehalten. /

More variants of drivers, driver accessories and RGB-control on request. Technical modifications reserved.

DRIVER VERWENDUNG / USE OF DRIVER

LEUCHE / LUMINAIRE	DRIVER	250 mA		350 mA			500 mA					700 mA				900 mA	1050 mA	UNI									
		CC-250-06-PC	CC-350-04s	CC-350-08	CC-350-13-PC	CC-350-15	CC-350-18-PC	CC-500-06	CC-500-06s	CC-500-06-PC	CC-500-10-PC	CC-500-12	CC-500-18-PC	CC-500-20	CC-500-21-PC	CC-700-06s	CC-700-10-PC	CC-700-15-PC	CC-700-25-PC	CC-700-35-PC	CC-900-40	CC-1050-22	CC-UNI-42	CC-UNI-DIM-20	CC-UNI-DIM-20-M	CC-UNI-DIM-60	CC-UNI-DIM-60-M
ALASKA										1	1	1	1-2	2									1-2	1-2	1-2	1-3 ²	1-6
CENTRO					1	1	1																1	1	1	1-2	1-2
CENTRO XL																			1				1			1	1-2
CITY																							1			1-2	
CITY S																						1	1-2			1-3	
CITY XS																						1-2	1-4			1-6 ²	
CLIPPO EP												1	1										1	1	1	1-2	1-4
CPX 115												1	1	1									1	1	1	1-2	1-2
CPX 170																				1			1			1	
CREDO (12,6 W LED dim to warm)					1		1																	1	1	1-2	1-2
CREDO (9,3W LED module)										1	1	1	1-2	2									1-2	1-2	1-2	1-3	1-6
CREDO (14W LED module)												1	1										1	1	1	1-2	1-4
DOT ¹															1-2	3-4 ²	4-6 ²	6-10 ²					1-13 ²	1-8 ²	2-8 ²	1-20 ²	2-24 ²
DOT Q ¹															1-2	3-4 ²	4-6 ²	6-10 ²					1-13 ²	1-8 ²	2-8 ²	1-20 ²	2-24 ²
GANYMED										1	1	1	1-2	2									1-2	1-2	1-2	1-3	1-6
IDOWN 13					1	1	1																1	1	1	1	1-2
IDOWN 26																			1				1			1	1-2
KYO (12,6 W LED dim to warm)					1		1																	1	1	1-2 ²	1-2
KYO (9,3W LED module)										1	1	1	1-2	2									1-2	1-2	1-2	1-3 ²	1-6
KYO (14W LED module)												1	1										1	1	1	1-2 ²	1-4
LEDA															1-2	3-4 ²	4-6 ²	6-10 ²					1-13 ²	1-8 ²	2-8 ²	1-20 ²	2-24 ²
LINEA 1															1-3	3-5 ²	5-7 ²	7-12 ²					2-15 ²	1-9 ²	3-9 ²	1-20 ²	3-28 ²
LINEA 5																	1	2	2-3				1-3	1	1	1-5	1-4
LINEA 5 FLEX																	1	2	2-3				1-3	1	1	1-5	1-4
LINEA 10																		1	1				1	1	1	1-2	1-2
LINEA WALLWASHER																		1	2				1	1	1	1-3	1-2
LUCY EP										1	1	1	1-2	2									1-2	1-2	1-2	1-3 ²	1-4
MICRO															1-3	3-4	5-6	6-11 ²					1-14 ²	1-9 ²	2-9 ²	1-20 ²	2-26 ²
MICRO Q															1-3	3-4	5-6	6-11 ²					1-14 ²	1-9 ²	2-9 ²	1-20 ²	2-26 ²
OPUS (12,6 W LED dim to warm)					1		1																	1	1	1-2 ²	1-2
OPUS (9,3W LED module)										1	1	1	1-2	2									1-2	1-2	1-2	1-3 ²	1-6
OPUS Q (12,6 W LED dim to warm)					1		1																	1	1	1-2 ²	1-2
OPUS Q (9,3W LED module)										1	1	1	1-2	2									1-2	1-2	1-2	1-3 ²	1-6
PHANTOM								1-4	1-4	2-4	4-6	1-6		1-10									2-14 ²	1-12 ²	3-13 ²	1-20 ²	3-36 ²
PHOENIX					1	1	1																1	1	1	1-2 ²	1-2
PIXEL			1-4	1-6 ²		1-11																	2-14 ²	1-15 ²	3-19 ²	1-20 ²	3-36 ²
RENA (12,6 W LED dim to warm)					1		1																	1	1	1-2	1-2
RENA (9,3W LED module)										1	1	1	1-2	2									1-2	1-2	1-2	1-3	1-6
RIGA (12,6 W LED dim to warm)					1		1																	1	1	1-2 ²	1-2
RIGA (9,3W LED module)										1	1	1	1-2	2									1-2	1-2	1-2	1-3 ²	1-6
RIGA Q (12,6 W LED dim to warm)					1		1																	1	1	1-2 ²	1-2
RIGA Q (9,3W LED module)										1	1	1	1-2	2									1-2	1-2	1-2	1-3 ²	1-6
ROYAL										1	1	1	1-2	2									1-2	1-2	1-2	1-3	1-6
SATURNO IN										1	1	1	1-2	2									1-2	1-2	1-2	1-3	1-6
SMILE								1-4 ²	1-4	2-4 ²	4-6 ²	1-6 ²		1-10 ²									2-14 ²	1-12 ²	3-13 ²	1-20 ²	3-36 ²

DRIVER VERWENDUNG / USE OF DRIVER

LEUCHTE / LUMINAIRE	DRIVER		350 mA					500 mA					700 mA					900 mA	1050 mA	UNI								
	250 mA		CC-250-06-PC	CC-350-04s	CC-350-08	CC-350-13-PC	CC-350-15	CC-350-18-PC	CC-500-06	CC-500-06s	CC-500-06-PC	CC-500-10-PC	CC-500-12	CC-500-18-PC	CC-500-20	CC-500-21-PC	CC-700-06s	CC-700-10-PC	CC-700-15-PC	CC-700-25-PC	CC-700-35-PC	CC-900-40	CC-1050-22	CC-UNI-42	CC-UNI-DIM-20	CC-UNI-DIM-20-M	CC-UNI-DIM-60	CC-UNI-DIM-60-M
SMILE IP65 ¹								1-4 ²	1-4	2-4 ²	4-6 ²	1-6 ²		1-10 ²										2-14 ²	1-12 ²	3-13 ²	1-20 ²	3-36 ²
SMILE Q								1-4 ²	1-4	2-4 ²	4-6 ²	1-6 ²		1-10 ²										2-14 ²	1-12 ²	3-13 ²	1-20 ²	3-36 ²
SPAGO 60 EP																1-3	3-4	5-6	6-11					2-14	1-9	2-13	1-23 ²	2-26
SPAGO 90 EP																1-3	3-4	5-6	6-11					2-14	1-9	2-13	1-23 ²	2-26
TAIFUN								1-4	1-4	2-4	4-6	1-6		1-10										2-14 ²	1-12 ²	3-13 ²	1-20 ²	3-36 ²
TWO LIGHT												1	1	1-2	2									1-2	1-2	1-2	1-3	1-4
VARO																					1		1				1	
ZOOM								1-4 ²	1-4	2-4 ²	4-6 ²	1-6		1-10 ²										2-14 ²	1-12 ²	3-13 ²	1-20 ²	3-36 ²
ZOOM AB FLEX								1-4	1-4	2-4	4-6	1-6		1-10										2-14	1-12	3-13	1-20	3-36
ZOOM AB FLEX SWITCH								1-4	1-4	2-4	4-6	1-6		1-10										2-14	1-12	3-13	1-20	3-36
ZOOM DS								1-4	1-4	2-4	4-6	1-6		1-10										2-14	1-12	3-13	1-20	3-36
ZOOM TELE								1-4	1-4	2-4	4-6	1-6		1-10										2-14	1-12	3-13	1-20	3-36
ZOOM TELE 2								1-2	1-2	1-2	2-3	1-4		1-5										1-7	1-6	2-6	1-10	2-18
ZOOM XL (EP)	1																								1-2	1-3		

¹ IP Driver auf Anfrage / ¹ IP driver on request

² Ausschnittmaß Leuchte und Driverabmessungen berücksichtigen / ² Accommodate cut out of luminaire and dimension of driver

INFO dim to warm / INFO dim to warm

CREDO KYO OPUS OPUS Q RENA RIGA RIGA Q

- Lichtqualität und Dimmverhalten einer herkömmlichen Glühbirne kombiniert mit der Energieeffizienz der LED Technologie
- Farbtemperatur: 1910 K – 3000 K
- Leuchtenlichtstrom: 80 – 1175 Lumen
- Abstrahlwinkel: 15°, 25°, 38° und 60°
- Dimmen: dimmbar mit Phasenanschnitt-/Phasenabschnitt-dimmer, 1-10 V und DALI von 10 % – 100 %
- Light quality and dim characteristics of a conventional light bulb combined with the efficiency of the LED technology
- colour temperature: 1910 K – 3000 K
- luminous flux: 80 – 1175 Lumen
- beam angle: 15°, 25°, 38° and 60°
- Dimming: dimmable with trailing edge/leading edge dimmer, 1-10 V and DALI from 10 % – 100 %

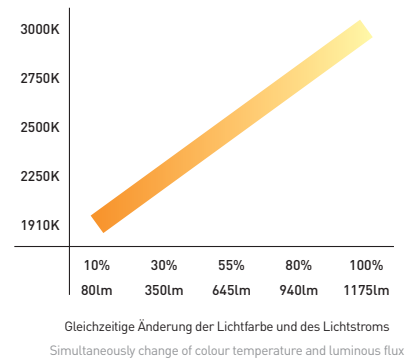

CLIPPO S CLIPPO DUO

- Lichtqualität und Dimmverhalten einer herkömmlichen Glühbirne kombiniert mit der Energieeffizienz der LED Technologie
- Farbtemperatur: 1910 K – 3000 K
- Leuchtenlichtstrom: 45-915 Lumen
- Abstrahlwinkel: 24°, 34° und 48°
- Dimmen: dimmbar mit Phasenanschnitt-/Phasenabschnitt-dimmer von 10 % – 100 %
- Light quality and dim characteristics of a conventional light bulb combined with the efficiency of the LED technology
- colour temperature: 1910 K – 3000 K
- luminous flux: 45-915 Lumen
- beam angle: 24°, 34° and 48°
- Dimming: dimmable with trailing edge/leading edge dimmer from 10 % – 100 %

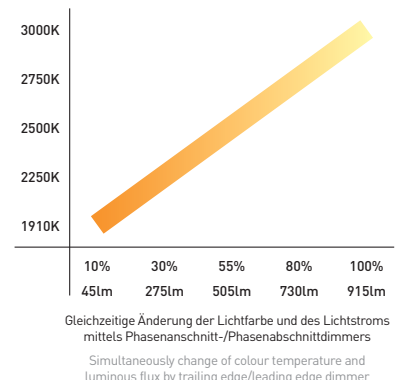

ALPHABETICAL INDEX

TYPE	PAGE	TYPE	PAGE	TYPE	PAGE
1-PHASE TRACK	190	LINEA 5 FLEX	106	TRANSFORMER	194
3-PHASE TRACK	192	LINEA WALLWASHER	106	TUBO	160
ALASKA	134	LP 5	184	TWO LIGHT	134
ATLANTIS 75	178	LP 7	184	VARO	154
ATLANTIS 95	178	LP 8	184	VEGA T FLEX	74
BALI	36	LUCKY STAR	82	VEGA TQ FLEX	74
BALI S	36	LUCY	102	VERONA	56
BALI L	37	LUCY EP	102	VIGO	166
BIG	144	MIAMI	54/160	VIGO Q	166
BRICK 15	50	MICRO	108	WEBSTER 400	174
BRICK 30	50	MICRO Q	108	WEBSTER 900	174
CABLE HOLDER	184	MK 90	142	YORK	176
CABLE KITS	184	MK 110	142	YORK 200	176
CAPRI	68	MK Q	142	ZOOM	24/109
CENTRO	150	NEWTON 35	32	ZOOM AB FLEX	72
CENTRO XL	150	NEWTON 55	32	ZOOM AB FLEX SWITCH	72
CHARME	56	NO FRAME 80	124	ZOOM DS	24
CITY	140	NO FRAME 80 DUO	124	ZOOM FLOOR	78
CITY S	140	NO FRAME 80 ROUND	128	ZOOM T FLEX	70
CITY XS	140	NO FRAME 150	126	ZOOM TABLE	78
CL 15	34/156	NO FRAME 150 DUO	126	ZOOM TELE	26
CLEO	40	NO FRAME 150 ROUND	128	ZOOM TELE 2	26
CLIPPO	6	OPUS	116	ZOOM TQ FLEX	70
CLIPPO DUO	8	OPUS Q	117	ZOOM XL	22
CLIPPO EP	9	ORBIT 1	48		
CLIPPO S	10	ORBIT 2	48		
CLIPPO S DUO	11	ORBIT 3	48		
CONE	144	ORBIT 4	49		
CPX 115	148	PHANTOM	88		
CPX 170	149	PHOENIX	136		
CREDO	112	PIPER	30		
DIEGO	160	PIPER S	30		
DIVA	158	PIXEL	84		
DIVA Q	158	REED	100		
DONUT	146	REED AB	100		
DOT	181	REED P1	101		
DOT Q	181	REED XL	91		
DRIVER	195	RENA	110		
FEELING	58	RIGA	118		
FLATBOX	64/166	RIGA Q	119		
FLOW T FLEX	76	RINGO	156		
FLOW TQ FLEX	76	RIO	164		
FRAME 150	130	RONA	76		
FRAME 150 DUO	130	ROY	56		
FRISCO	180	ROYAL	136		
GANYMED	132	SATIS	60		
GEO	12	SATURNO 1	14		
GINGER	54	SATURNO 2	14		
GINO	60	SATURNO IN	15		
HANG ON	58	SAXO	82		
HANGING BALI	38	SAXO ON	84/168		
HANGING BALI L	38	SCOTTY 3	180		
HANGING BALI S	38	SCOTTY 6	180		
HANGING PIPER	30	SECRET	62/162		
HARMONY	66	SECRET DOWN	62/162		
HENRY	54	SECRET UP	62/162		
IDOWN 13	138	SILENCE	64/168		
IDOWN 26	138	SMILE	86		
KELLY	90	SMILE IP65	86		
KENT	92	SMILE Q	86		
KENT BAKERY	98	SOHO	80		
KENT MEAT	98	SONO	146		
KENT S	94	SPAGO 60	42		
KENT S P1	95	SPAGO 90	42		
KUBUS	34	SPLIT	82		
KYO	114	SQUARE	120		
LARA	69	SQUARE DUO	120		
LEDA	108	STANDING CAPRI	68		
LIBERTY	159	STANLEY 1	170		
LIGHT BOX 1	18	STANLEY 2	170		
LIGHT BOX 2	18	STAR	184		
LIGHT BOX 3	18	STRATO 190	152		
LIGHT BOX 4	19	STRATO 230	152		
LIGHT BOX SOFT 1	16	STYLE DUO	28		
LIGHT BOX SOFT 2	16	STYLE Q	28		
LIGHT BOX SOFT 3	16	STYLE Q DUO	28		
LIGHT HOUSE 1	20	SUN	53		
LIGHT HOUSE 2	20	SUPREME 60	52		
LILLI	46	SUPREME 100	52		
LINEA 1	104	SUPREME 130	52		
LINEA 5	104	SYDNEY	174		
LINEA 10	104	TAIFUN	88		

CODE INDEX

CODE	TYPE	PAGE	CODE	TYPE	PAGE	CODE	TYPE	PAGE
131-09-00-01	ZOOM	24/109	D256	CITY S	140	D379	HANGING BALI	38
131-09-00-03	ZOOM	24/109	D257	CITY	140	D380	HANGING BALI	38
131-09-00-05	ZOOM	24/109	D258	CENTRO XL	150	D381	SQUARE	120
131-09-00-33	ZOOM	24/109	D262	SECRET DOWN	62/162	D382	SQUARE	120
132-09-00-01	ZOOM DS	24	D263	LINEA 1	104	D383	SQUARE DUO	120
132-09-00-03	ZOOM DS	24	D265	LINEA 1	104	D384	SQUARE DUO	120
132-09-00-05	ZOOM DS	24	D266	LINEA 5 FLEX	106	D385	LIGHT BOX SOFT 1	16
132-09-00-33	ZOOM DS	24	D267	LINEA 5 FLEX	106	D386	LIGHT BOX SOFT 2	16
133-09-00-01	ZOOM TELE	26	D271	LINEA 10	104	D387	LIGHT BOX SOFT 3	16
133-09-00-05	ZOOM TELE	26	D272	LINEA 10	104	D403	KYO	114
133-09-00-33	ZOOM TELE	26	D273	LINEA WALLWASHER	106	D404	KYO	114
134-09-00-01	ZOOM XL	22	D275	LINEA WALLWASHER	106	D405-	KYO	114
134-09-00-03	ZOOM XL	22	D276	LINEA 5	104	D406	BIG	144
134-09-00-05	ZOOM XL	22	D277	LINEA 5	104	D407	BIG	144
134-09-00-33	ZOOM XL	22	D279	PIXEL	84	D408-	KYO	114
135-09-00-05	ZOOM TABLE	78	D285	CHARME	56	D409-	KYO	114
135-09-00-33	ZOOM TABLE	78	D286	GINGER	54	D410-	KYO	114
136-09-00-01	ZOOM T FLEX	70	D287	HANG ON	58	D411	NO FRAME 80	124
136-09-00-05	ZOOM T FLEX	70	D288	HENRY	54	D412	NO FRAME 80	124
136-09-00-33	ZOOM T FLEX	70	D289	LEDA	108	D415	NO FRAME 80 DUO	124
137-09-00-01	ZOOM TQ FLEX	70	D290	LEDA	108	D416	NO FRAME 80 DUO	124
137-09-00-05	ZOOM TQ FLEX	70	D296	LEDA	108	D420-	PHANTOM	88
137-09-00-33	ZOOM TQ FLEX	70	D297	SPLIT	82	D421-	TAIFUN	88
139-09-00-01	ZOOM AB FLEX	72	D298	SPLIT	82	D422	CL 15	34/156
139-09-00-05	ZOOM AB FLEX	72	D299	VERONA	56	D423	SONO	146
139-09-00-33	ZOOM AB FLEX	72	D301	BRICK 15	50	D424-	OPUS	116
140-09-00-01	ZOOM AB FLEX SWITCH	72	D302	BRICK 30	50	D425-	OPUS	116
140-09-00-05	ZOOM AB FLEX SWITCH	72	D303	BRICK 15	50	D426-	OPUS	116
140-09-00-33	ZOOM AB FLEX SWITCH	72	D304	BRICK 30	50	D427-	OPUS	116
141-09-00-05	ZOOM FLOOR	78	D305	CLIPPO S DUO	11	D428-	OPUS	116
141-09-00-33	ZOOM FLOOR	78	D306	BIG	144	D429-	OPUS	116
142-09-00-01	ZOOM TELE 2	26	D307	BIG	144	D432	NO FRAME 80 ROUND	128
142-09-00-05	ZOOM TELE 2	26	D308	ROY	56	D433	NO FRAME 80 ROUND	128
142-09-00-33	ZOOM TELE 2	26	D309	ROY	56	D434	OPUS	116
492-09-00-01	SMILE	86	D310	CLIPPO S DUO	11	D435	OPUS	116
492-09-00-03	SMILE	86	D312	BALI	36	D439	HENRY dim	54
492-09-00-05	SMILE	86	D313	BALI	36	D440	CONE	144
492-09-00-33	SMILE	86	D314	BALI	36	D441	CONE	144
494-09-00-40	SMILE IP65	86	D315	BALI	36	D442	CONE	144
494-09-00-41	SMILE IP65	86	D319	DONUT	146	D443-	OPUS Q	117
756-11-20-03	SPAGO 60	42	D323	SONO	146	D444-	OPUS Q	117
756-11-20-05	SPAGO 60	42	D324	BALI S	36	D445-	OPUS Q	117
759-11-20-03	SPAGO 90	42	D325	BALI S	36	D446-	OPUS Q	117
759-11-20-05	SPAGO 90	42	D328	BALI S	36	D447-	OPUS Q	117
760-09-29- -01	VEGA T FLEX	74	D329	BALI S	36	D448-	OPUS Q	117
760-09-29- -05	VEGA T FLEX	74	D331	CLIPPO S DUO	11	D449	OPUS Q	117
760-09-29- -33	VEGA T FLEX	74	D332	STYLE Q	28	D450	OPUS Q	117
761-09-29- -01	VEGA TQ FLEX	74	D333	STYLE Q	28	D451	NO FRAME 150	126
761-09-29- -05	VEGA TQ FLEX	74	D334	STYLE Q DUO	28	D452	NO FRAME 150	126
761-09-29- -33	VEGA TQ FLEX	74	D335	STYLE Q DUO	28	D455	NO FRAME 150 DUO	126
833-09-15-01	FLOW TQ FLEX	76	D336	CLIPPO S DUO	11	D456	NO FRAME 150 DUO	126
833-09-15-05	FLOW TQ FLEX	76	D338	CLIPPO S	10	D465-	KYO	114
833-09-15-33	FLOW TQ FLEX	76	D342	CLIPPO S	10	D469-	KYO	114
852-09-15-01	FLOW T FLEX	76	D344	STYLE DUO	28	D471	NO FRAME 150 ROUND	128
852-09-15-05	FLOW T FLEX	76	D345	CLIPPO S	10	D472	NO FRAME 150 ROUND	128
852-09-15-33	FLOW T FLEX	76	D348	CLIPPO S	10	D480	SQUARE	120
892-09-00-03	SMILE Q	86	D351	CL 15	34/156	D481	SQUARE	120
892-09-00-05	SMILE Q	86	D352	CL 15	34/156	D482	SQUARE DUO	120
892-09-00-33	SMILE Q	86	D353	LINEA 10	104	D483	SQUARE DUO	120
D200	SECRET DOWN	62/162	D354	LINEA 10	104	D491	FRAME 150	130
D201	SECRET DOWN	62/162	D355	BRICK 15	50	D492	FRAME 150	130
D202	SAXO	82	D356	BRICK 30	50	D495	FRAME 150 DUO	130
D203	SAXO ON	84/168	D357	HANGING BALI S	38	D496	FRAME 150 DUO	130
D204	MIAMI	54/160	D358	HANGING BALI S	38	D500	LINEA 1	104
D205	SATIS	60	D359	HANGING BALI S	38	D501	LINEA 1	104
D206	FLATBOX	64/166	D360	LIGHT BOX 4	19	D502	BIG	144
D208	STRATO 190	152	D361	LIGHT BOX 1	18	D504	BIG	144
D210	STRATO 230	152	D362	LIGHT BOX 2	18	D508	ORBIT 1	48
D211	HANGING PIPER	30	D363	LIGHT BOX 3	18	D510	ORBIT 2	48
D212	CENTRO	150	D364	HANGING BALI S	38	D512	ORBIT 3	48
D220	SILENCE	64/168	D365	HANGING BALI	38	D514	ORBIT 4	49
D221	SILENCE	64/168	D367	LIGHT BOX 1	18	D521	KUBUS	34
D229	PIXEL	84	D368	LIGHT BOX 2	18	D522	KUBUS	34
D239	SECRET	62/162	D369	LIGHT BOX 3	18	D523	KUBUS	34
D244	RIO	164	D370	LIGHT BOX 4	19	D524	CPX 115	148
D245	GINO	60	D371	LIGHT BOX 1	18	D525	CPX 115	148
D246	SECRET	62/162	D372	LIGHT BOX 2	18	D526	CPX 115	148
D247	SECRET	62/162	D373	LIGHT BOX 3	18	D527	CPX 115	148
D249	ROYAL	136	D374	LIGHT BOX SOFT 1	16	D528	CPX 170	149
D252	PIPER S	30	D375	LIGHT BOX SOFT 2	16	D529	CPX 170	149
D253	PIPER	30	D376	LIGHT BOX SOFT 3	16	D530	CPX 170	149
D255	LILLI	46	D377	HANGING BALI	38	D531	CPX 170	149

CODE INDEX

CODE	TYPE	PAGE	CODE	TYPE	PAGE	CODE	TYPE	PAGE
D532	LINEA 5	104	D719-	LUCY	102	D876-	CREDO	112
D533	LINEA 5	104	D722-	LUCY	102	D879-	CREDO	112
D534	LINEA 5 FLEX	106	D732-	KENT	92	D883-	RENA	110
D535	LINEA 5 FLEX	106	D734-	KENT	92	D886-	KYO	114
D536	LINEA WALLWASHER	106	D736-	KENT BAKERY	98	D889-	CREDO	112
D537	LINEA WALLWASHER	106	D739-	KENT BAKERY	98	D891-	LUCY EP	102
D538	SOHO	80	D742-	KENT	92	D894-	LUCY EP	102
D539	SOHO	80	D745-	KENT	92	D901-	CREDO	112
D545-	CREDO	112	D748	NEWTON 35	32	D902	HANGING BALI L	38
D549-	CREDO	112	D749	MK Q	142	D903	HANGING BALI L	38
D557	SATURNO IN	15	D751	VARO	154	D904	HANGING BALI L	38
D558	SATURNO IN	15	D752	PIPER S dim	30	D905	HANGING BALI L	38
D559	SATURNO IN	15	D753	PIPER dim	30	D906	BALI L	37
D560	SATURNO IN	15	D756	BRICK 30 LED	50	D907	BALI L	37
D563	REED P1	101	D757	BRICK 15 LED	50	D908	BALI L	37
D564	REED P1	101	D758	BRICK 30 LED	50	D909	BALI L	37
D567	REED P1	101	D759	BRICK 15 LED	50	D910-	CREDO	112
D568	REED P1	101	D762-	LUCY	102	D911	NO FRAME 80	124
D575-	RENA	110	D766-	KENT MEAT	98	D912	NO FRAME 80	124
D579-	RENA	110	D769-	KENT MEAT	98	D913	VIGO	166
D583	RENA	110	D772-	LUCY	102	D914	VIGO	166
D584	RENA	110	D774	GANYMED	132	D915	NO FRAME 80 DUO	124
D587	CREDO	112	D775	CLIPPO	6	D916	NO FRAME 80 DUO	124
D588	CREDO	112	D776	GANYMED	132	D919-	LUCY EP	102
D593	KELLY	90	D777	CLIPPO	6	D922-	LUCY EP	102
D594	KELLY	90	D779	GANYMED	132	D923-	CREDO	112
D597	KELLY	90	D780	GANYMED	132	D924	SATURNO 1	14
D598	KELLY	90	D781	TWO LIGHT	134	D925	SATURNO 1	14
D600	RONA	76	D782	TWO LIGHT	134	D926	SATURNO 1	14
D605	GEO	12	D784	FEELING	58	D927	SATURNO 1	14
D606	FLATBOX	64/166	D786	MK 90	142	D928-	MICRO	108
D607	GEO	12	D787	MK 110	142	D929-	MICRO	108
D608	MIAMI	54/160	D788	NEWTON 35	32	D932	NO FRAME 80 ROUND	128
D609	CLIPPO DUO	8	D789	LUCKY STAR	82	D933	NO FRAME 80 ROUND	128
D610	CLIPPO DUO	8	D791	IDOWN 13	138	D934	SATURNO 2	14
D611	CLIPPO DUO	8	D792	IDOWN 26	138	D935	SATURNO 2	14
D612	CLIPPO DUO	8	D793	CITY XS	140	D936	SATURNO 2	14
D613	CLIPPO DUO	8	D798	ALASKA	134	D937	SATURNO 2	14
D614	CLIPPO DUO	8	D800-	RIGA	118	D938	SECRET UP	62/162
D615	CLIPPO DUO	8	D801-	RIGA	118	D939	SECRET	62/162
D616	CLIPPO DUO	8	D802-	RIGA	118	D940	CONE	144
D617	CLEO	40	D803-	RIGA	118	D941	CONE	144
D619	CLEO	40	D804-	RIGA	118	D942	CONE	144
D620	SILENCE	64/168	D805-	RIGA	118	D943	VIGO Q	166
D621	LARA	69	D806	RIGA	118	D944	VIGO Q	166
D622	REED	100	D807	RIGA	118	D945	CLIPPO	6
D623	REED	100	D808	DIEGO	160	D946	SECRET UP	62/162
D625	HARMONY	66	D809	RINGO	156	D947	CLIPPO	6
D626	HARMONY LED FLEX	66	D813	STANLEY 2	170	D948	NEWTON 55	32
D628-	REED XL	91	D814	STANLEY 1	170	D949	SECRET UP	62/162
D629-	REED XL	91	D819	SUN	53	D950	CAPRI	68
D631	PHOENIX	136	D820	SCOTTY 6	180	D951	CAPRI	68
D632	REED	100	D821	SCOTTY 3	180	D952	STANDING CAPRI	68
D633	REED	100	D823	DOT	181	D953	STANDING CAPRI	68
D642	REED AB	100	D824	DOT Q	181	D954-	KENT S P1	95
D643	REED AB	100	D825	FRISCO	180	D955-	KENT S P1	95
D645	GINO	60	D826	SYDNEY	174	D956	CITY S	140
D646	GINO	60	D827	YORK	176	D957	CITY	140
D647	GINO	60	D829	RINGO	156	D958-	MICRO Q	108
D652	REED AB	100	D830	SYDNEY	174	D959-	MICRO Q	108
D653	REED AB	100	D831	YORK	176	D962-	KENT S	94
D668-	RIGA Q	119	D832	YORK 200	176	D966-	KENT S	94
D669-	RIGA Q	119	D833	WEBSTER 900	174	D970-	KENT S	94
D673	SUPREME 60	52	D834	WEBSTER 400	174	D974-	KENT S	94
D674	CLIPPO EP	9	D837	YORK 200	176	D978-	KENT S	94
D675	CLIPPO EP	9	D838	DIVA	158	D982-	KENT S	94
D676	CLIPPO EP	9	D839	DIVA Q	158	D984-	CREDO	112
D677	CLIPPO EP	9	D840	LIBERTY	159	D985	CLIPPO	6
D678	SUPREME 100	52	D841	TUBO	160	D986	GINGER	54
D680	SUPREME 130	52	D842	DIEGO	160	D987	CLIPPO	6
D682	CLIPPO EP	9	D843	DOT	181	D988	NEWTON 55	32
D683	CLIPPO EP	9	D844	LIBERTY plus	159	D989-	KENT S P1	95
D692	CLIPPO EP	9	D845	ATLANTIS 95	178	D990-	KENT S P1	95
D693	CLIPPO EP	9	D846	ATLANTIS 75	178	D991-	KENT S P1	95
D694-	RIGA Q	119	D847	ATLANTIS 75	178	D992-	KENT S P1	95
D695-	RIGA Q	119	D853-	KYO	114	D993	CITY XS	140
D696-	RIGA Q	119	D856-	KYO	114	D994	LIGHT HOUSE 1	20
D697-	RIGA Q	119	D859-	KYO	114	D995	CLIPPO	6
D698	RIGA Q	119	D863-	RENA	110	D996	LIGHT HOUSE 2	20
D699	RIGA Q	119	D866-	RENA	110	D997	CLIPPO	6
D702	SAXO	82	D869-	RENA	110			
D711	HANGING PIPER dim	30	D873-	CREDO	112			



Ein Produkt von / a product of

EGGER Licht GmbH

Obere Tiebelgasse 7 - 9560 Feldkirchen, Austria

Tel +43 (0) 4276 55 07 - Fax +43 (0) 4276 55 07-13

office@dslighting.com

www.dslighting.com